



BLACK FOSTER
THE INVISIBLE BLACK, IN A LINEAR SYSTEM

ARKOSLIGHT®

BLACK FOSTER

CUSTOM · RECESSED · TRIMLESS · SURFACE · SUSPENDED · SPOTLIGHTS



ARKOSLIGHT®

THE INVISIBLE BLACK, IN A LINEAR SYSTEM

Black Foster is the new Arkoslight product, which brings the acclaimed 'The Invisible Black' effect to a linear system. A lighting technological feature that allows Black Foster to hide the origin of the light while bathing the scene and generates a spectacular effect: light in space, with no visible source.



THE SAME AESTHETICS, BOTH ON OR OFF

By hiding the origin of the light, Black Foster manages to always keep the same look - turned on or off -.

This creates an attractive psychological sensation in the spectator who perceives the light in the room, but he is surprised to see that the luminary is apparently off.

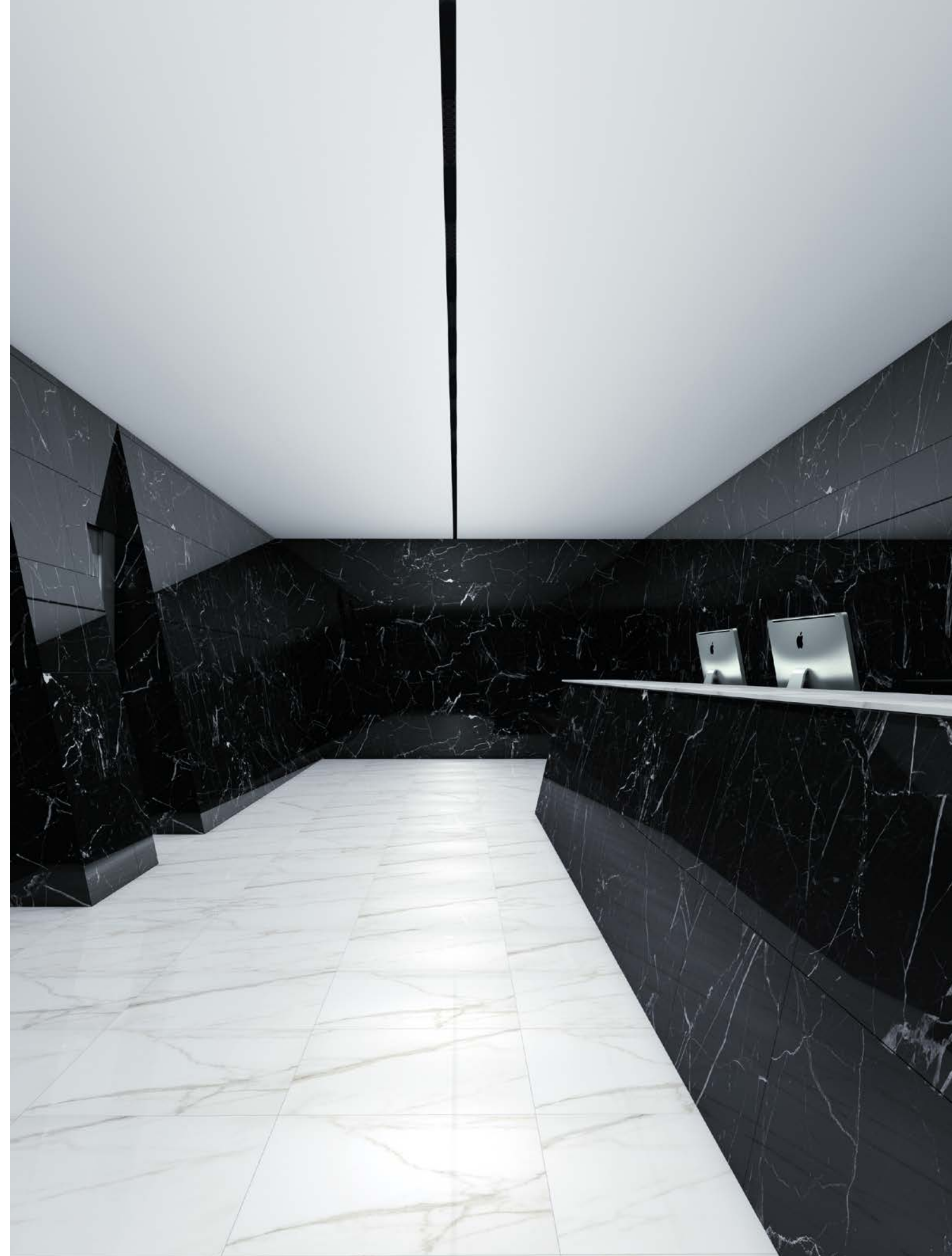



A PERFECT DARK LINE

The homogeneity of the dark line that is achieved throughout the course of Black Foster "Custom", is an ally of visual order, neutrality and elegance in the design of spaces.

With Black Foster the lighting becomes minimalist and non-invasive, the luminary thus passes unnoticed and abdicates the focus of attention.

FULLY CUSTOMIZABLE

Consisted of combinable segments (with light emission and gaps), the modularity of Black Foster "Custom" gives a total compositional flexibility. Customer will be able to configure its own dark line and place on it the light emission freely as both types of segments are -almost- visually indistinguishable once installed.



THE INVISIBLE BLACK & PROJECTION LIGHT

Black Foster Custom integrates the track lights Plus, Six and Fit to combine the effect "Invisible Black" with projection lighting, while maintaining an elegant and discrete aesthetic.

The track lights can be easily installed at any point of the system adapting themselves to the specific needs of each project. In addition to Plus Mini, Six S and Fit 35, the wide range of Arkoslight track lights is available under special order.



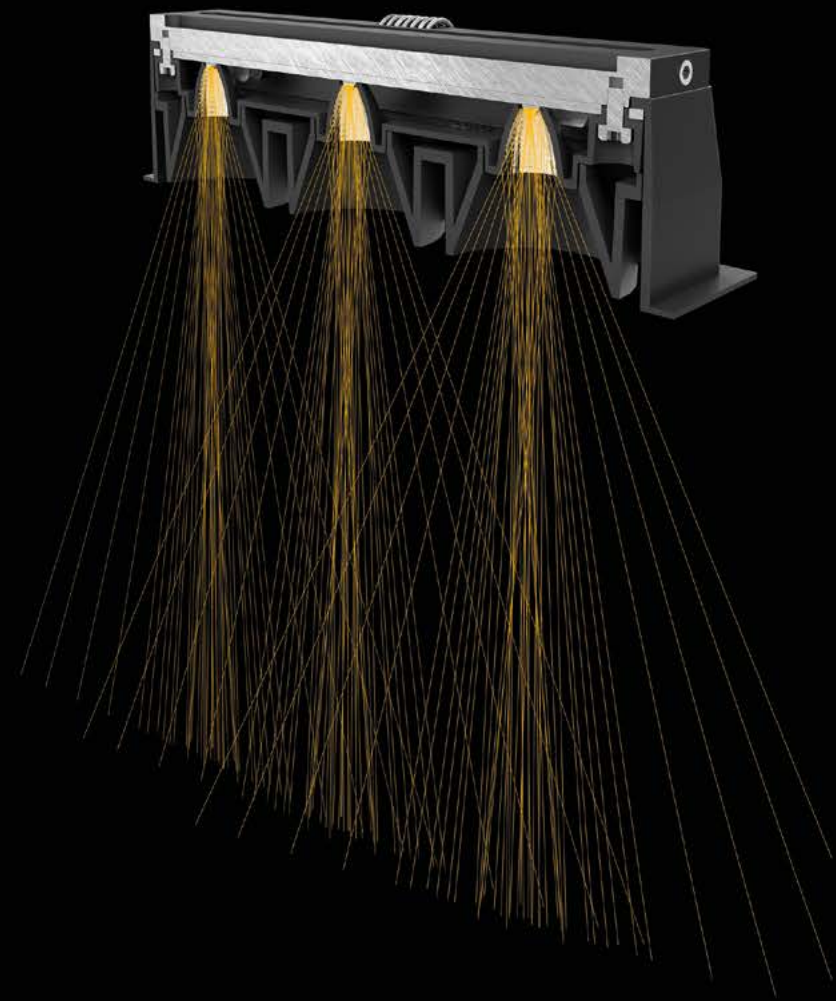

LIGHT BEAM HYPERCONTROLLED

Besides being an excellent luminaire for the overall lighting function, Black Foster is a perfect element for lighting support or highlighting certain interior design elements as desired. Meanwhile in overall lighting it stands out for its low glare and high visual comfort, in highlighting function it benefits from its perfect controlled light beam which maximizes the LED light flow.

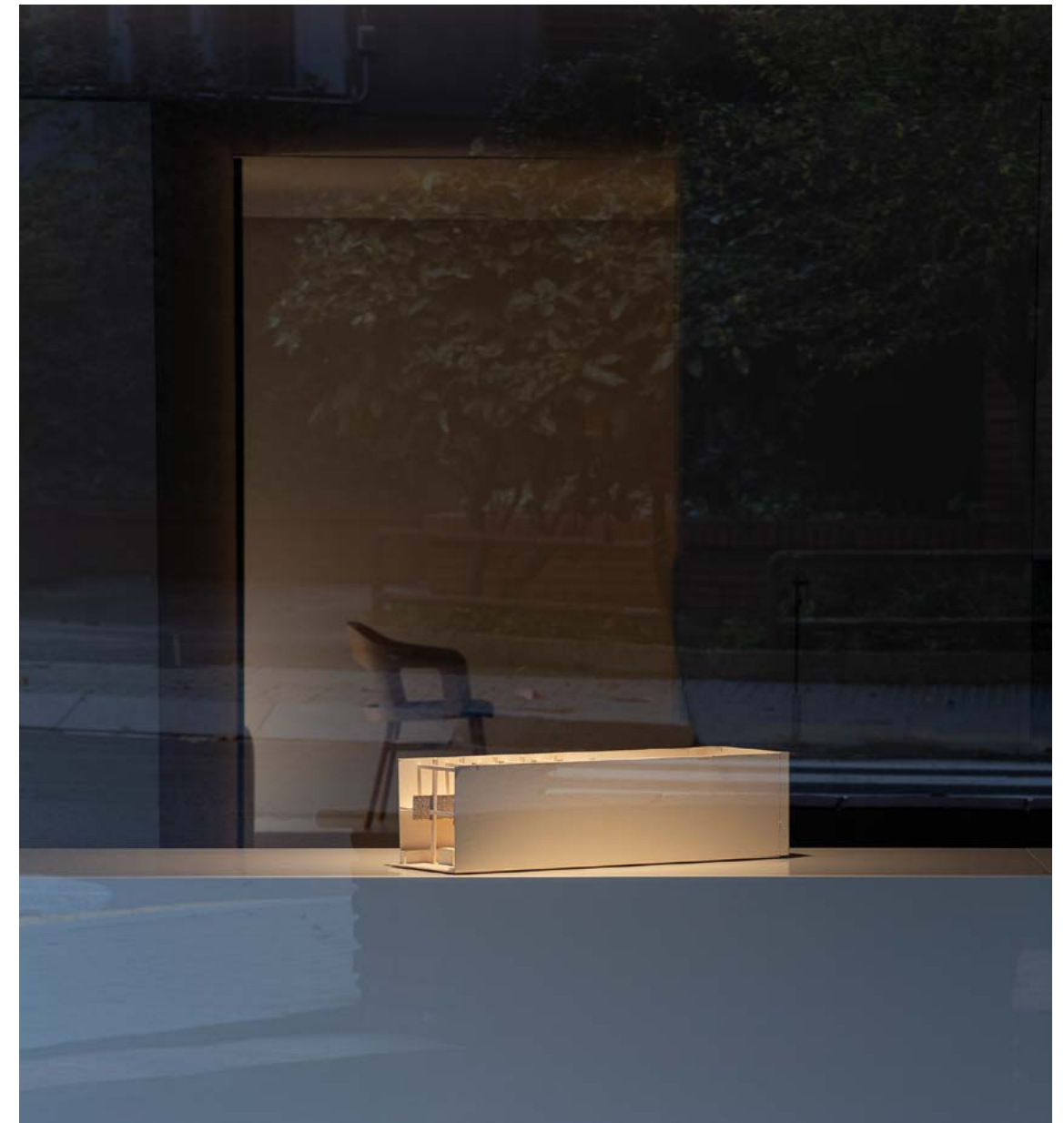



VERY LOW GLARING

The Black Foster technology reduces the glaring effect down to a very low level thanks to the high beam control, which concentrates the light rays so that they flow to the outside without hardly any deviations from the delimited angle. On the other hand, its anti-glare screen in 'technical black' finish absorbs the minimum losses and prevents the piece from shining or reflecting the light.

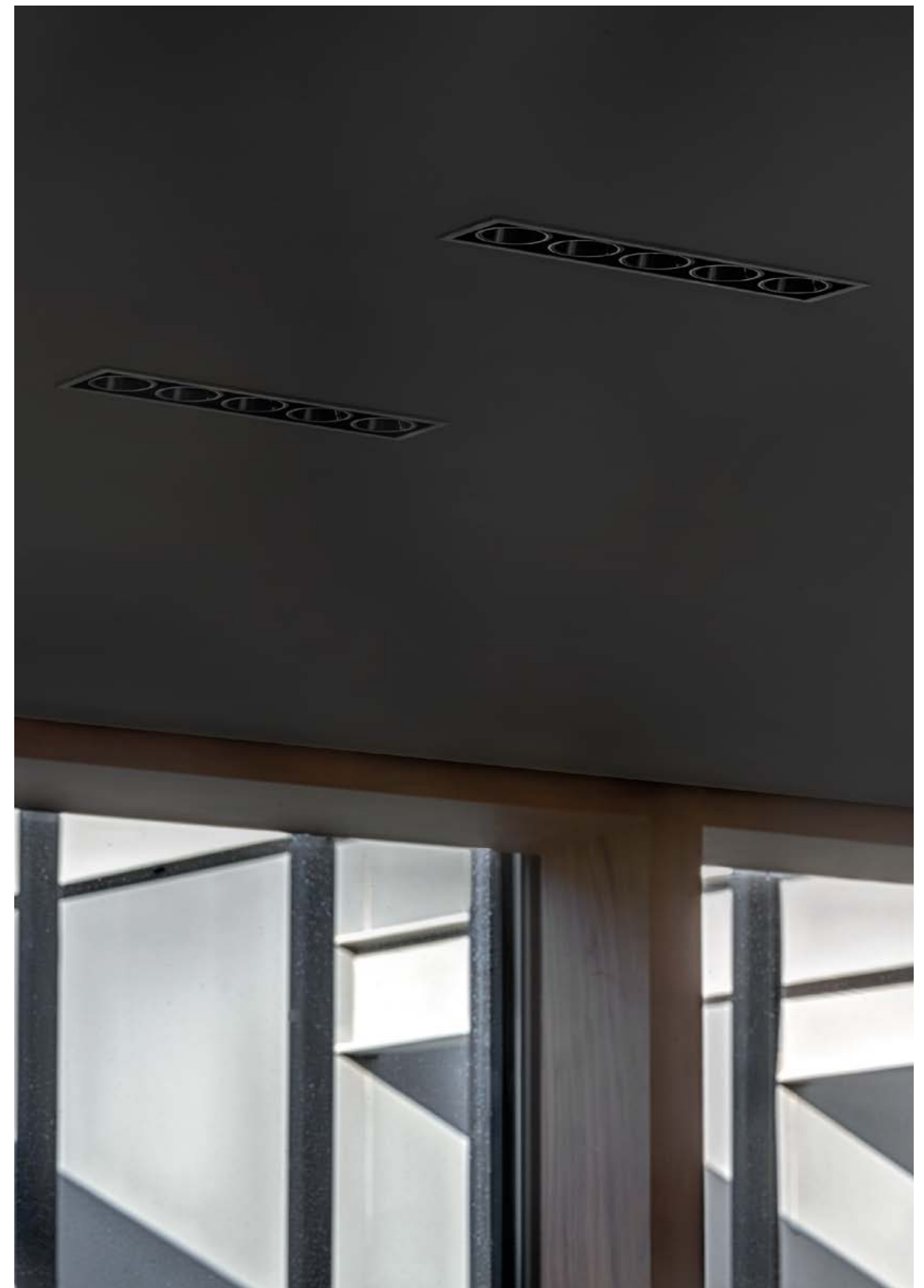

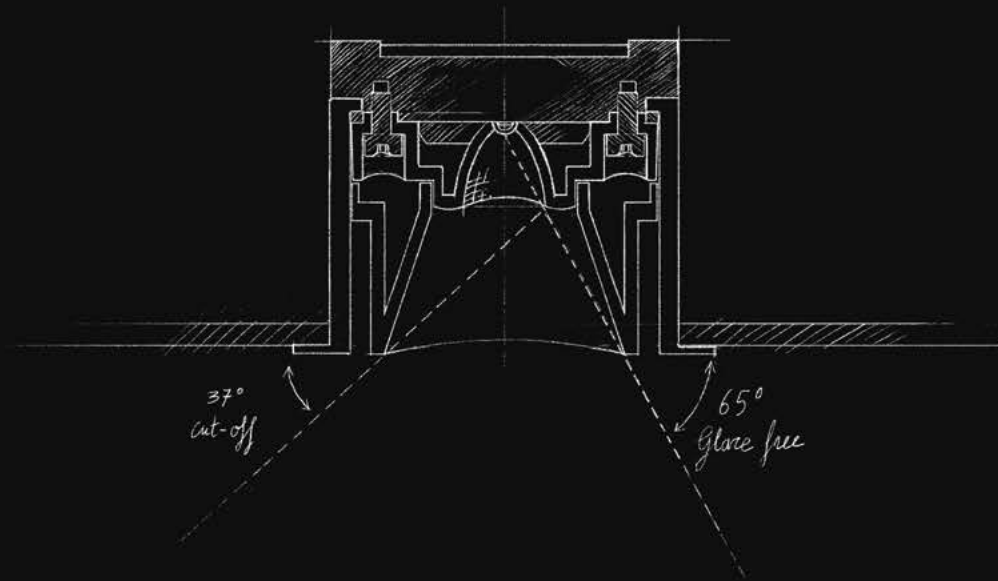

VISUAL COMFORT, IN ITS UTMOST EXPRESSION

The secret of a high visual comfort and the difficulty of a visual access at the source of Black Foster's lighting lies in the high screening level achieved by the recessed position of the LED, the miniaturization of its reflector and the "technical black" finish of its screen.

Black Foster's cut-off angle (absolute visual comfort) is at 37° and the glare-free angle (no direct vision of the LED) is at 65°. These values result in an index close to UGR 0 in almost any disposition. Therefore, Black Foster easily meets the UGR<19 requirement (the strictest requirement against glaring in the technical codes and international regulations).

INTEGRATION IN ARCHITECTURE

The masking of the origin of light is the technical characteristic that better helps the integration of a luminary in architecture, as its visual presence becomes significantly minored for the user of the space.

Concerning Black Foster, the spectator will be only able to have a direct view of the source of light standing right under it. Perceiving any kind of light disturbance within the field of vision has been effectively restricted to a narrow range of angles.



MINIATURIZATION AND AVANT-GARDE

Within the design of Black Foster, the spirit of minimalist modern-architecture and the will of the finest integration of light in interior design; are faithfully represented.

It's reduced dimensions and its tactful presence conform the essence of this piece, enshrining in its small size, a technical vanguard of the latest generation.



METALLIC GOLD FINISHING

Arkoslight incorporates Metallic Gold into its color and finishings. This new color provides greater perceived quality, and transmits solidness, luxury, warmth and comfort.

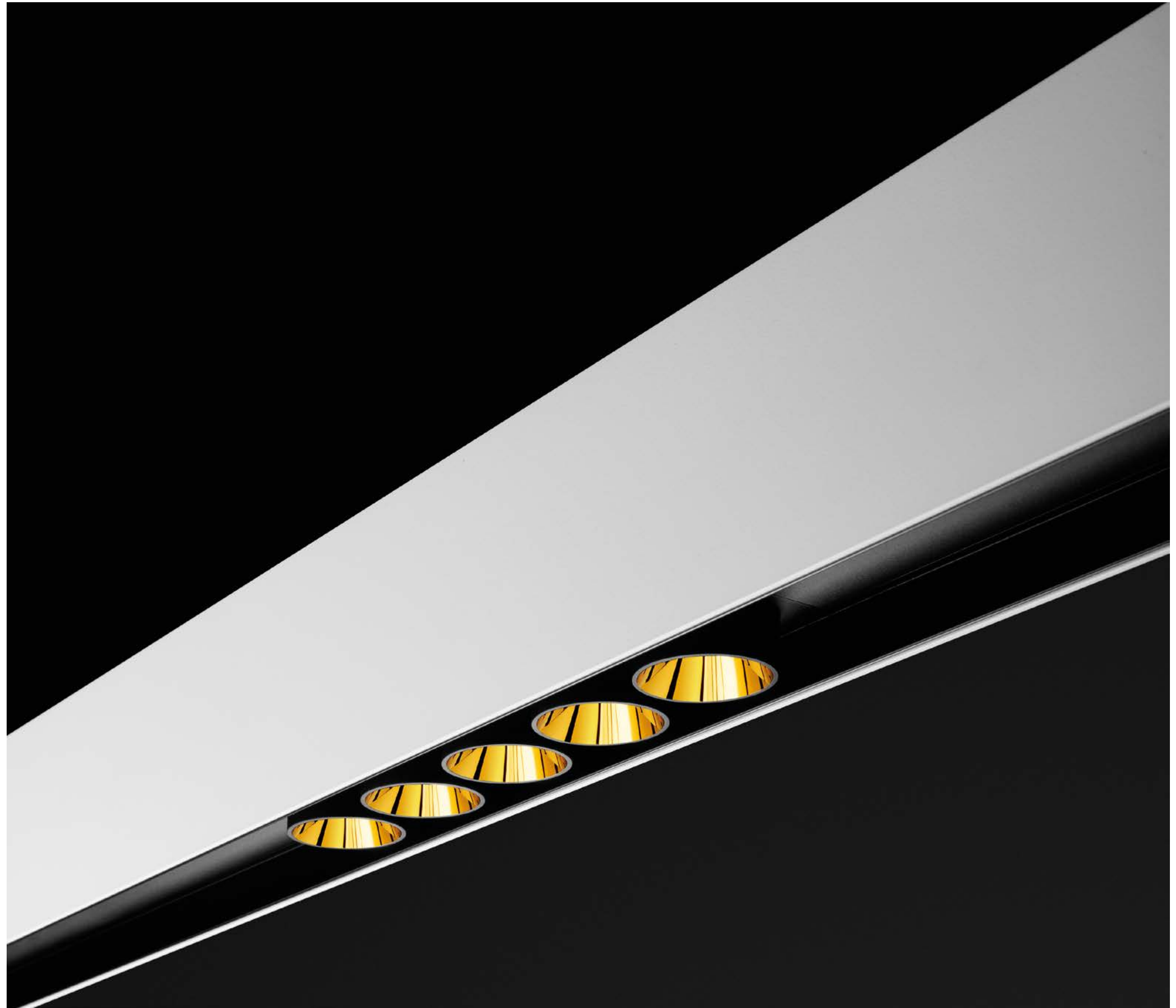



BLACK FOSTER ASYMMETRIC

Black Foster is offered with asymmetric light emission in its Recessed, Trimless and Custom variants.



A HUGE RANGE OF VERSIONS

BLACK FOSTER

RECESSED

It stands out for its bezel, very thin and narrow, which practically disappears after being installed and generates a trimless optical effect.

BLACK FOSTER RECESSED 1



BLACK FOSTER RECESSED 2 & BLACK FOSTER ASYMMETRIC RECESSED 2



BLACK FOSTER RECESSED 3 & BLACK FOSTER ASYMMETRIC RECESSED 3



BLACK FOSTER RECESSED 5 & BLACK FOSTER ASYMMETRIC RECESSED 5



BLACK FOSTER
TRIMLESS

BLACK FOSTER TRIMLESS 1



BLACK FOSTER TRIMLESS 2 & BLACK FOSTER ASYMMETRIC TRIMLESS 2



BLACK FOSTER TRIMLESS 3 & BLACK FOSTER ASYMMETRIC TRIMLESS 3



BLACK FOSTER TRIMLESS 5 & BLACK FOSTER ASYMMETRIC TRIMLESS 5



BLACK FOSTER TRIMLESS 10 & BLACK FOSTER ASYMMETRIC TRIMLESS 10



BLACK FOSTER TRIMLESS 15 & BLACK FOSTER ASYMMETRIC TRIMLESS 10



BLACK FOSTER

MICRO RECESSED

Black Foster Micro is a feat of engineering which brings the acclaimed 'The Invisible Black' effect to a hyper-reduced light.

Its tiny size and thin trim offer a 'trimless visual' aesthetic which combines with its almost imperceptible presence as a result of its compact dimensions.

BLACK FOSTER MICRO RECESSED 3



BLACK FOSTER MICRO RECESSED 5



BLACK FOSTER MICRO RECESSED 2 X 2



BLACK FOSTER MICRO RECESSED 3 X 3



BLACK FOSTER

MICRO 24V

Black Foster Micro 24V for Minimal Track, the most compact downlight with 'The Invisible Black' effect.

This linear luminaire has an excellent control of the light beam whose rays do not bathe the luminaire and are channelled directly to the exterior without touching the screen. Furthermore, its reduced design enables an absolutely perfect installation of the modules into systems.

BLACK FOSTER MICRO 24V 5



BLACK FOSTER
MICRO 48V

BLACK FOSTER MICRO 48V 5



BLACK FOSTER MICRO 48V 10



BLACK FOSTER SURFACE

BLACK FOSTER SURFACE 1



BLACK FOSTER SURFACE 2



BLACK FOSTER SURFACE 3



BLACK FOSTER SURFACE 5



BLACK FOSTER SURFACE 10



BLACK FOSTER SURFACE 15





BLACK FOSTER SUSPENSION 1200



BLACK FOSTER SUSPENSION 1600



BLACK FOSTER SUSPENSION

The translation of anti-glare virtues of Black Foster to this suspended version make this luminary the ideal solution to light up working places. Furthermore, its on-board DIM regulation allows the user to individually adjust the amount of light he desires in his work plane.



BLACK FOSTER
CUSTOM

A perfect dark line where light comes out from. A customizable system that can be configured combining light and dark segments which cannot be distinguished. That's what we call "Invisible Black"

In addition, this system includes 3 track lights that can be installed at any point of its length in order to enrich the product with accent lighting.



BLACK FOSTER
CUSTOM SURFACE

A perfect dark line where light comes out from. A customizable system that can be configured combining light and dark segments which cannot be distinguished. That's what we call "Invisible Black"

In addition, this system includes 3 track lights that can be installed at any point of its length in order to enrich the product with accent lighting.



JUMA architects | Susana Ocaña | Photography: Eugeni Pons

BLACK FOSTER
MICRO CUSTOM
SURFACE

A perfect dark line where light comes out from. A customizable system that can be configured combining light and dark segments which cannot be distinguished. That's what we call "Invisible Black"

In addition, this system includes 3 track lights that can be installed at any point of its length in order to enrich the product with accent lighting.



BLACK FOSTER TECHNICAL SPECIFICATIONS

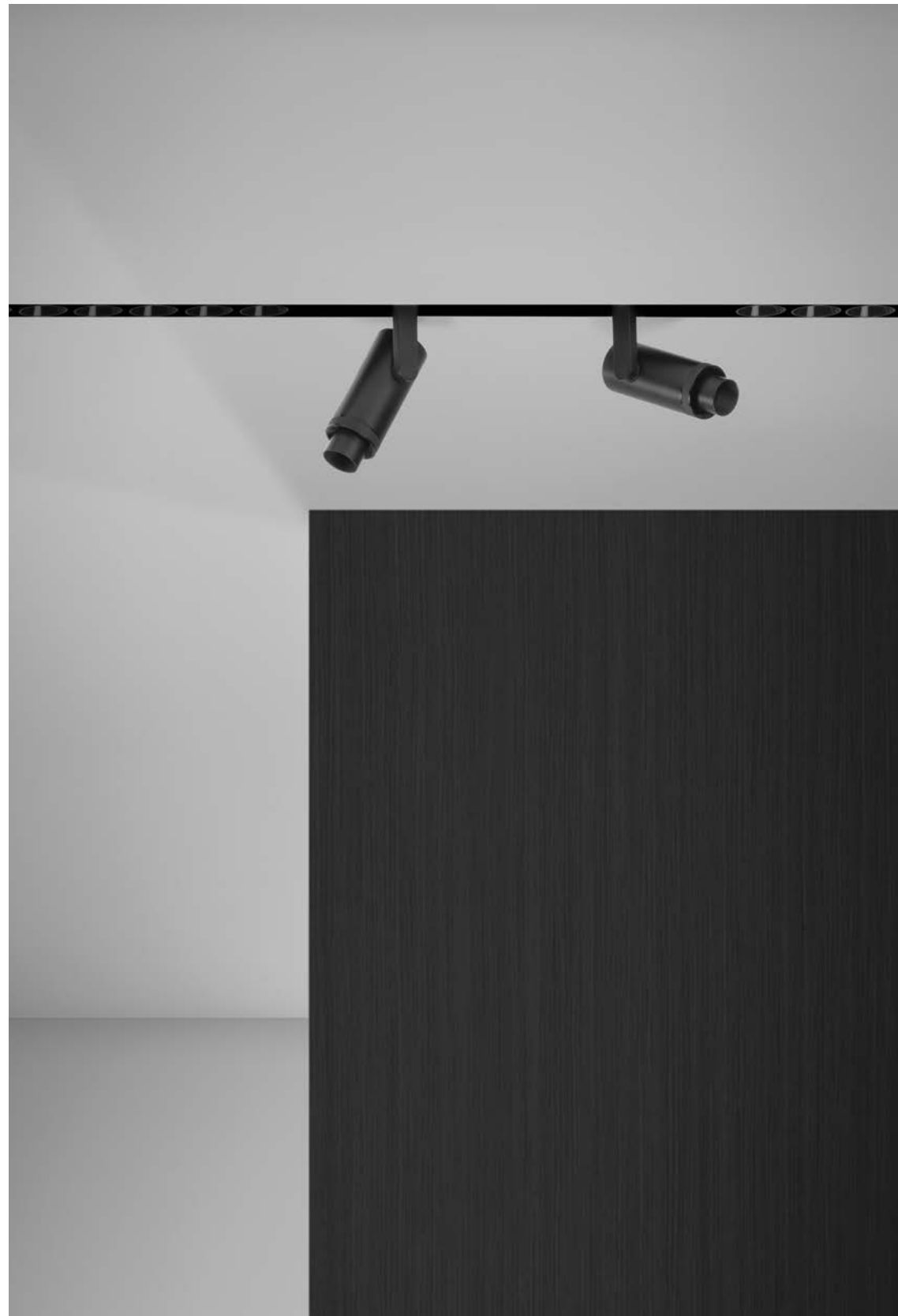

BLACK FOSTER CUSTOM

		P	CCT	I	Flux	L
BLACK FOSTER Custom 2	A317-2- ○ -00- N NMG	4,2W	2700K	700mA	380Lm	87mm
	A317-2- ○ -01- N NMG	4,2W	3000K	700mA	420Lm	87mm
	A317-2- ○ -02- N NMG	4,2W	4000K	700mA	500Lm	87mm
BLACK FOSTER Custom 3	A317-3- ○ -00- N NMG	6,3W	2700K	700mA	570Lm	130mm
	A317-3- ○ -01- N NMG	6,3W	3000K	700mA	630Lm	130mm
	A317-3- ○ -02- N NMG	6,3W	4000K	700mA	750Lm	130mm
BLACK FOSTER Custom 5	A317-4- ○ -00- N NMG	10,5W	2700K	700mA	950Lm	216mm
	A317-4- ○ -01- N NMG	10,5W	3000K	700mA	1050Lm	216mm
	A317-4- ○ -02- N NMG	10,5W	4000K	700mA	1250Lm	216mm
BLACK FOSTER Custom 10	A317-5- ○ -00- N NMG	21W	2700K	700mA	1900Lm	431mm
	A317-5- ○ -01- N NMG	21W	3000K	700mA	2100Lm	431mm
	A317-5- ○ -02- N NMG	21W	4000K	700mA	2500Lm	431mm
BLACK FOSTER Custom 15	A317-6- ○ -00- N NMG	31,5W	2700K	700mA	2850Lm	646mm
	A317-6- ○ -01- N NMG	31,5W	3000K	700mA	3150Lm	646mm
	A317-6- ○ -02- N NMG	31,5W	4000K	700mA	3750Lm	646mm

III IP20 | CRI>90 | L80B10 >60.000h



○	BEAM	LOR
0	38°	92%
1	19°	90%

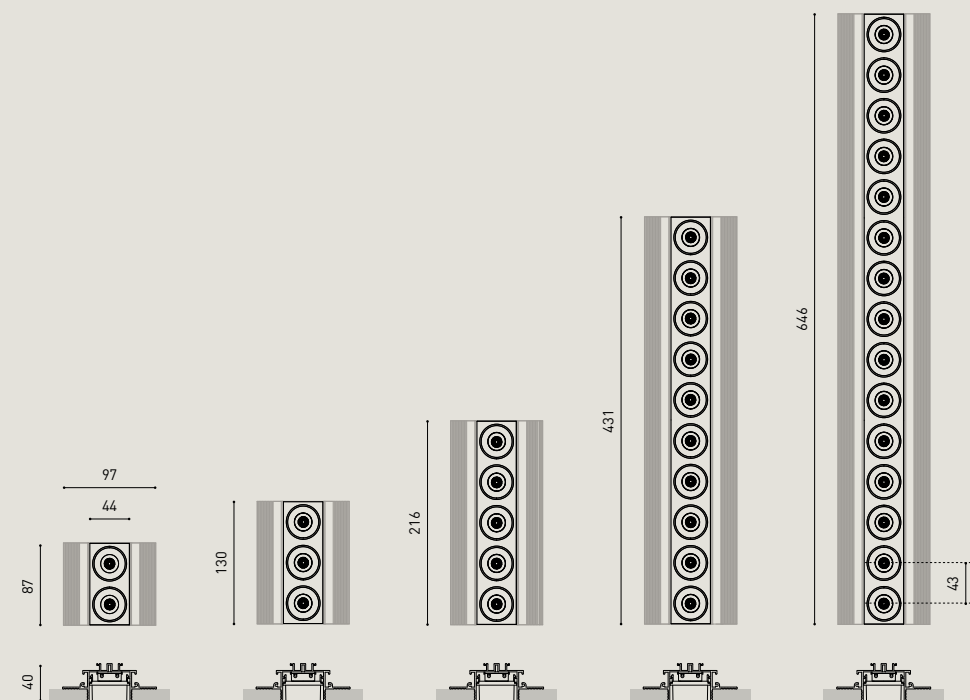

COLOUR | N ■ | NMG ■ | MATERIAL | AL | ABS+PC

PLASTERBOARD CEILING, MANDATORY THICKNESS 12,5mm. RECOMMENDED FOR INSTALLATIONS WHERE THE PROFILE CAN BE INSTALLED BEFORE THE FALSE PLASTERBOARD CEILING.

((())) » PLEASE CONSULT

BLACK FOSTER ASYMMETRIC CUSTOM

		P	CCT	I	Flux	LOR	L
BLACK FOSTER Asymmetric Custom 2	A372-20-00- N	4,2W	2700K	700mA	380Lm	90%	87mm
	A372-20-01- N	4,2W	3000K	700mA	420Lm	90%	87mm
	A372-20-02- N	4,2W	4000K	700mA	500Lm	90%	87mm
BLACK FOSTER Asymmetric Custom 3	A372-30-00- N	6,3W	2700K	700mA	570Lm	90%	130mm
	A372-30-01- N	6,3W	3000K	700mA	630Lm	90%	130mm
	A372-30-02- N	6,3W	4000K	700mA	750Lm	90%	130mm
BLACK FOSTER Asymmetric Custom 5	A372-40-00- N	10,5W	2700K	700mA	950Lm	90%	216mm
	A372-40-01- N	10,5W	3000K	700mA	1050Lm	90%	216mm
	A372-40-02- N	10,5W	4000K	700mA	1250Lm	90%	216mm
BLACK FOSTER Asymmetric Custom 10	A372-50-00- N	21W	2700K	700mA	1900Lm	90%	431mm
	A372-50-01- N	21W	3000K	700mA	2100Lm	90%	431mm
	A372-50-02- N	21W	4000K	700mA	2500Lm	90%	431mm
BLACK FOSTER Asymmetric Custom 15	A372-60-00- N	31,5W	2700K	700mA	2850Lm	90%	646mm
	A372-60-01- N	31,5W	3000K	700mA	3150Lm	90%	646mm
	A372-60-02- N	31,5W	4000K	700mA	3750Lm	90%	646mm

III IP20 | CRI>90 | L80B10 >60.000h

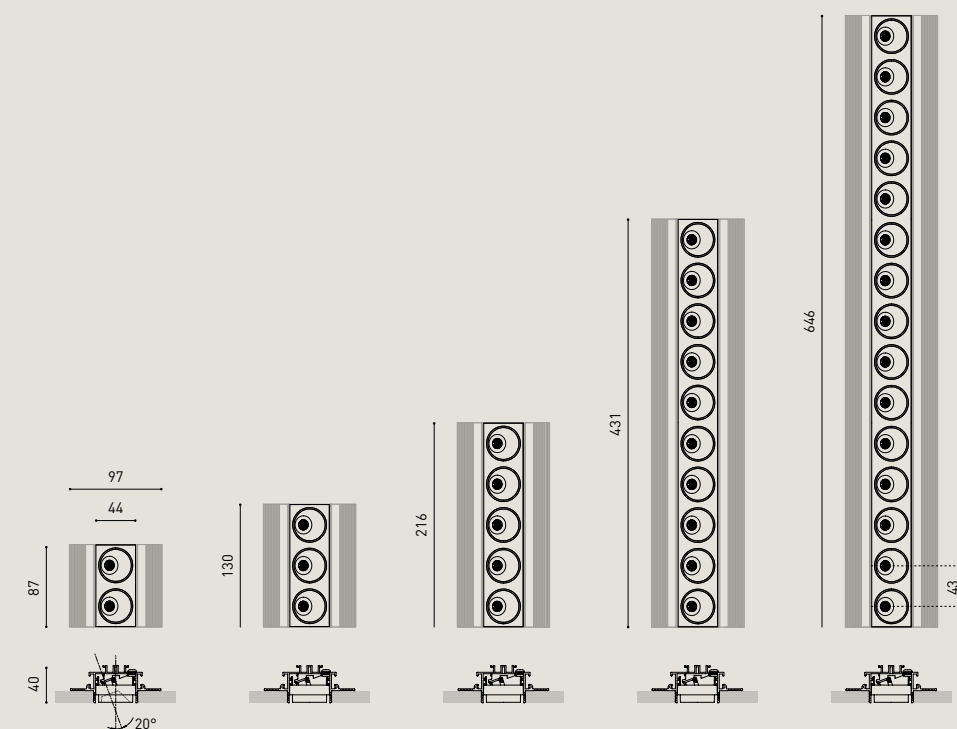

COLOUR | N ■ | MATERIAL | AL | ABS+PC

PLASTERBOARD CEILING, MANDATORY THICKNESS 12,5mm. RECOMMENDED FOR INSTALLATIONS WHERE THE PROFILE CAN BE INSTALLED BEFORE THE FALSE PLASTERBOARD CEILING.

((())) » PLEASE CONSULT

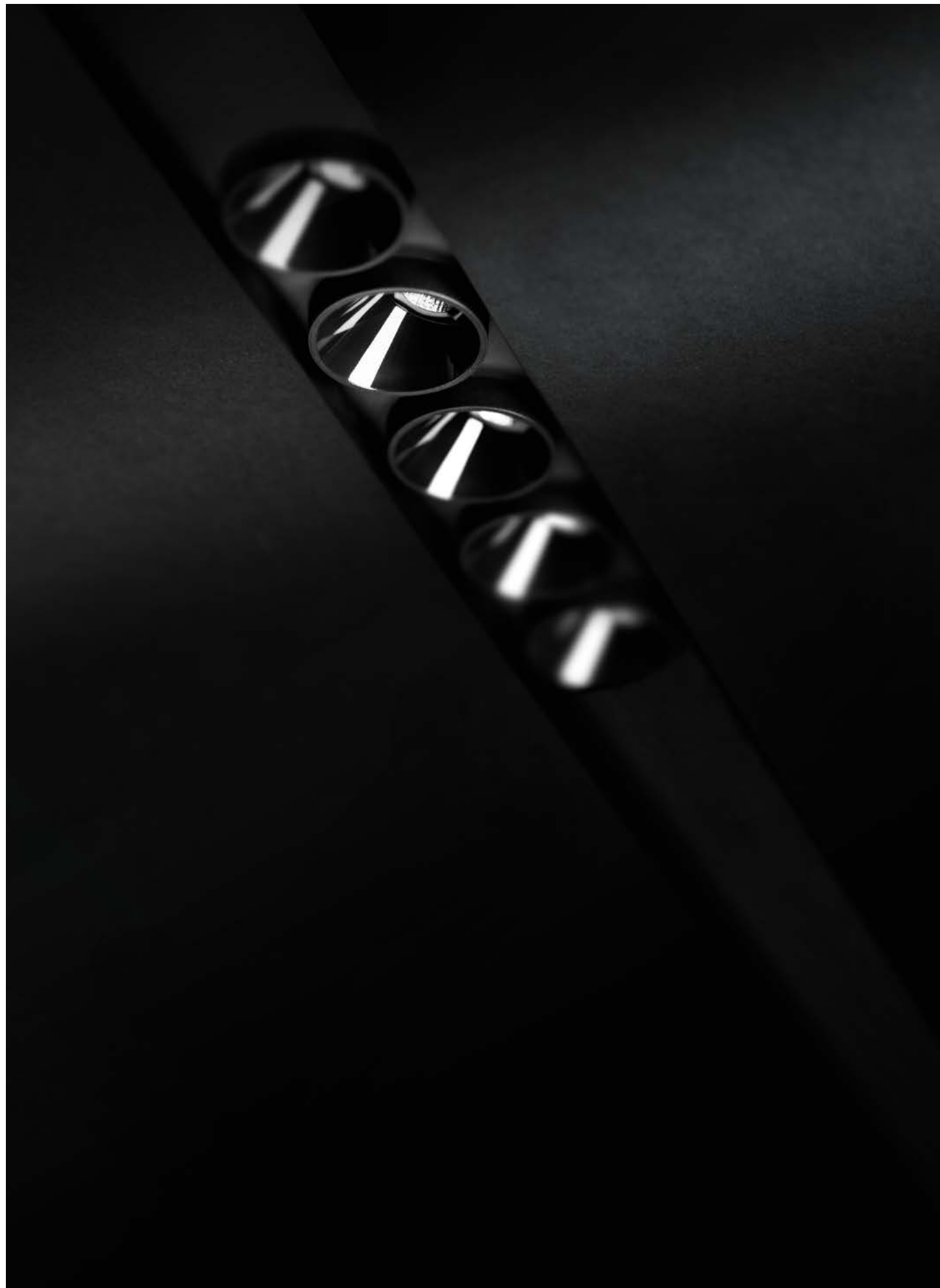

L

BLACK FOSTER Custom	Gap Corner 90°	A317-00-07- N 	200 x 200mm
	Gap 250	A317-00-01- N 	250mm
	Gap 500	A317-00-02- N 	500mm
	Gap 1000	A317-00-03- N 	1000mm
	Gap 2000	A317-00-04- N 	2000mm

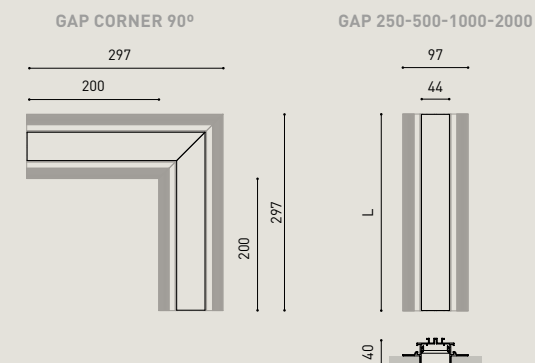

BLACK FOSTER End Caps Kit	A317-00-05- N 	Thickness of each cover=2mm.
----------------------------------	--------------------------	------------------------------

BLACK FOSTER Straight Joiner	A317-00-06
-------------------------------------	-------------------

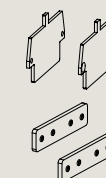

			P	I	D
DRIVER OPTIONS*	NO DIM	0434-01-18	50W	700mA	124 x 79 x 22mm
	DALI PUSH / 1-10V	0433-00-23	50W	700mA	124 x 79 x 22mm

220V~ | 240V~ | DRIVER MUST BE PLACED ON REMOTE | Phase cut please consult

Connect in series.

MOUNTING ACCESSORIES

BLACK FOSTER Track Fixation Kit	A219-21-06- B
--	--------------------------

BLACK FOSTER Track Flush Ceiling Kit	A219-22-06- B
---	--------------------------

BLACK FOSTER Track Clamp Kit for M6 ROD	A219-21-21- B
--	--------------------------

BLACK FOSTER Track Suspension Kit	A219-21-10- B
--	--------------------------



SUGGESTED MOUNTING ACCESSORIES QUANTITIES

Black Foster custom 2, 3, 5: 1 Pcs.
 Black Foster custom 10, 15: 2 Pcs.
 Gap 250, 500: 1 Pcs.
 Gap 1000, 2000: 2 Pcs.

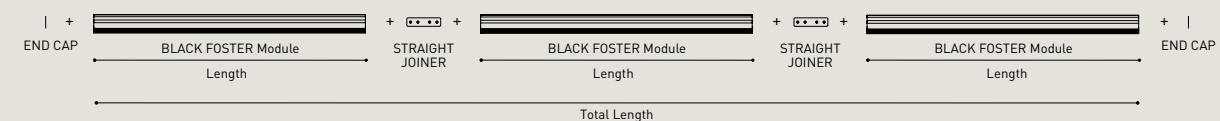

COLOUR | **N** | **B** | MATERIAL | **AL** | **ABS+PC**

PLASTERBOARD CEILING, MANDATORY THICKNESS 12,5mm. RECOMMENDED FOR INSTALLATIONS WHERE THE PROFILE CAN BE INSTALLED BEFORE THE FALSE PLASTERBOARD CEILING.

» PLEASE CONSULT

BLACK FOSTER CUSTOM

SIX S

		P	CCT	BEAM	I	Flux	LOR
BLACK FOSTER SIX S	A360-0- ☉ -10- WT NT	8,5W	2700K	17°	500mA	1030Lm	86%
	A360-0- ☉ -11- WT NT	8,5W	3000K	17°	500mA	1070Lm	86%
	A360-0- ☉ -12- WT NT	8,5W	4000K	17°	500mA	1100Lm	86%
	A360-0- ☉ -20- WT NT	8,5W	2700K	24°	500mA	1030Lm	84%
	A360-0- ☉ -21- WT NT	8,5W	3000K	24°	500mA	1070Lm	84%
	A360-0- ☉ -22- WT NT	8,5W	4000K	24°	500mA	1100Lm	84%
	A360-0- ☉ -30- WT NT	8,5W	2700K	34°	500mA	1030Lm	89%
	A360-0- ☉ -31- WT NT	8,5W	3000K	34°	500mA	1070Lm	89%
	A360-0- ☉ -32- WT NT	8,5W	4000K	34°	500mA	1100Lm	89%

220V~
240V~ | IP20 | CRI>90 | L80B10 >60.000h

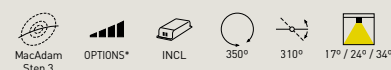

☉ *OPTIONS

1	No DIM
2	DIM DALI

ACCESSORY

SIX S High Chromatic LED**

NOT SOLD SEPARATELY

» 080

BLACK FOSTER SIX S

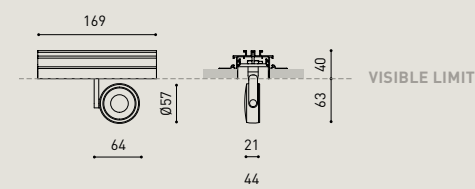

COLOUR | WT RAL 9016 | NT RAL 9005 | MATERIAL | AL | PC | ABS+PC | » 080

** ACCESSORY & COLOURS AFFECTS THE LIGHTING PARAMETERS
PLASTERBOARD CEILING, MANDATORY THICKNESS 12,5mm. RECOMMENDED FOR INSTALLATIONS
WHERE THE PROFILE CAN BE INSTALLED BEFORE THE FALSE PLASTERBOARD CEILING.

& » PLEASE CONSULT



BLACK FOSTER CUSTOM
PLUS MINI

		P	CCT	BEAM	I	Flux	LOR
BLACK FOSTER PLUS Mini	A362-00- -0- WT NT	6,5W	2700K	10°-41°	700mA	630Lm	20-40%
	A362-00- -1- WT NT	6,5W	3000K	10°-41°	700mA	660Lm	20-40%
	A362-00- -2- WT NT	6,5W	4000K	10°-41°	700mA	680Lm	20-40%

220V~
240V~ | IP20 | CRI>90 | L80B10 >60.000h

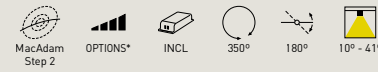

*OPTIONS

1	No DIM
2	DIM DALI

ACCESSORY

PLUS mini High Chromatic LED**

NOT SOLD SEPARATELY



BLACK FOSTER PLUS MINI

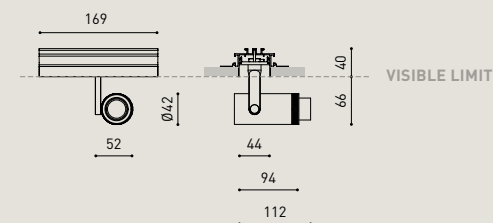

COLOUR | WT RAL 9016 | NT RAL 9005 | MATERIAL | AL | OPTICAL GLASS | ABS+PC | >> 080

** ACCESSORY AFFECTS THE LIGHTING PARAMETERS
PLASTERBOARD CEILING, MANDATORY THICKNESS 12,5mm. RECOMMENDED FOR INSTALLATIONS
WHERE THE PROFILE CAN BE INSTALLED BEFORE THE FALSE PLASTERBOARD CEILING.



BLACK FOSTER CUSTOM
FIT Ø35

		P	CCT	BEAM	I	Flux	LOR
BLACK FOSTER FIT 35	A363-0- -10- WT NT G	5,5W	2700K	19°	500mA	590Lm	82%
	A363-0- -11- WT NT G	5,5W	3000K	19°	500mA	630Lm	82%
	A363-0- -20- WT NT G	5,5W	2700K	29°	500mA	590Lm	80%
	A363-0- -21- WT NT G	5,5W	3000K	29°	500mA	630Lm	80%
	A363-0- -30- WT NT G	5,5W	2700K	38°	500mA	590Lm	80%
	A363-0- -31- WT NT G	5,5W	3000K	38°	500mA	630Lm	80%

220V~
240V~ | IP20 | CRI>90 | L80B10 >60.000h



*OPTIONS

1	No DIM
2	DIM DALI

ACCESSORY

FIT Ø35 Anti-glare Honeycomb Louver ** A345-00-00

NOT SOLD SEPARATELY



BLACK FOSTER FIT Ø35

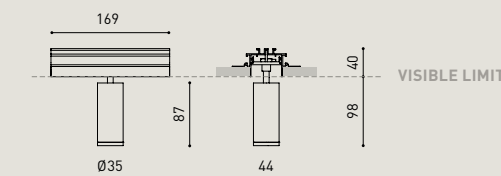

COLOUR | WT RAL 9016 | NT RAL 9005 | G RAL 1036 | MATERIAL | AL | PC | ABS+PC | >> 058

** ACCESSORY AFFECTS THE LIGHTING PARAMETERS
PLASTERBOARD CEILING, MANDATORY THICKNESS 12,5mm. RECOMMENDED FOR INSTALLATIONS
WHERE THE PROFILE CAN BE INSTALLED BEFORE THE FALSE PLASTERBOARD CEILING.

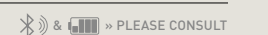

BLACK FOSTER CUSTOM SURFACE

		P	CCT	I	Flux
BLACK FOSTER Custom Module 3	A453-3- ○ - ① -0- N NMG	6,3W	2700K	700mA	570Lm
	A453-3- ○ - ① -1- N NMG	6,3W	3000K	700mA	630Lm
	A453-3- ○ - ① -2- N NMG	6,3W	4000K	700mA	750Lm
BLACK FOSTER Custom Module 5	A453-4- ○ - ① -0- N NMG	10,5W	2700K	700mA	950Lm
	A453-4- ○ - ① -1- N NMG	10,5W	3000K	700mA	1050Lm
	A453-4- ○ - ① -2- N NMG	10,5W	4000K	700mA	1250Lm
BLACK FOSTER Custom Module 10	A453-5- ○ - ① -0- N NMG	21W	2700K	700mA	1900Lm
	A453-5- ○ - ① -1- N NMG	21W	3000K	700mA	2100Lm
	A453-5- ○ - ① -2- N NMG	21W	4000K	700mA	2500Lm

48 V | III | IP20 | CRI>90 | L80B10 >60.000h



○ BEAM	LOR
0 38°	92%
1 19°	90%

① *OPTIONS
1 No DIM
2 DIM DALI

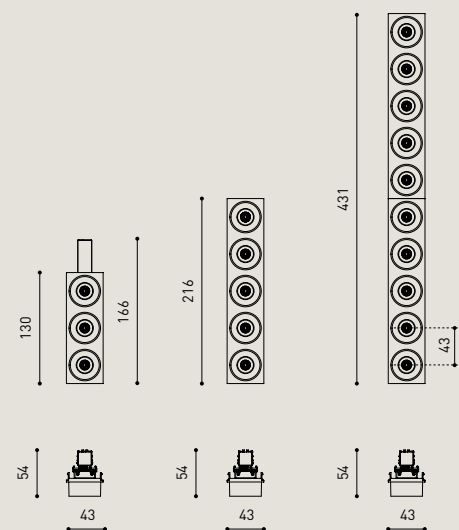

COLOUR | N ■ | NMG ■ | MATERIAL | AL | ABS+PC

((())) » PLEASE CONSULT



	P	CCT	I	Flux
BLACK FOSTER Custom Module FIT 27				
A454-0- - -0- WT NT G	5,5W	2700K	500mA	550Lm
A454-0- - -1- WT NT G	5,5W	3000K	500mA	600Lm
A454-0- - -2- WT NT G	5,5W	4000K	500mA	640Lm

48V | IP20 | CRI>90 | L80B10 >60.000h



	BEAM	LOR
1	22°	84%
2	37°	82%
3	46°	81%

	*OPTIONS
1	No DIM
2	DIM DALI

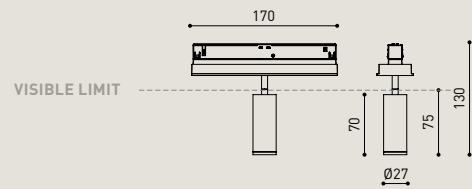

COLOUR | WT | NT | G | MATERIAL | AL | PC

» PLEASE CONSULT

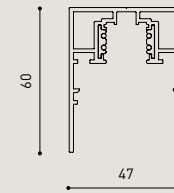

BLACK FOSTER Custom Surface 1m	A452-01-00- NT WT
BLACK FOSTER Custom Surface 2m	A452-02-00- NT WT
BLACK FOSTER Custom Surface 3m	A452-03-00- NT WT

BLACK FOSTER Custom Surface L-Joint	A452-04-00- NT WT
BLACK FOSTER Custom Surface T-Joint	A452-05-00- NT WT
BLACK FOSTER Custom Surface X-Joint	A452-06-00- NT WT

	P	V	D (A x B x C)
Constant Voltage LED POWER SUPPLY	0434-01-61* N	100W 48V	198 x 16 x 19mm
	0434-01-62	150W 48V	350 x 30 x 18mm



DROP VOLTAGE TABLE

POWER (W)	CABLE SECTION (mm ²)	CABLE LENGTH (m)			
		5	10	20	30
100	0,75	50	50	X	X
	1,5	50	50	40	25
150	0,75	40	15	X	X
	1,5	50	40	20	X

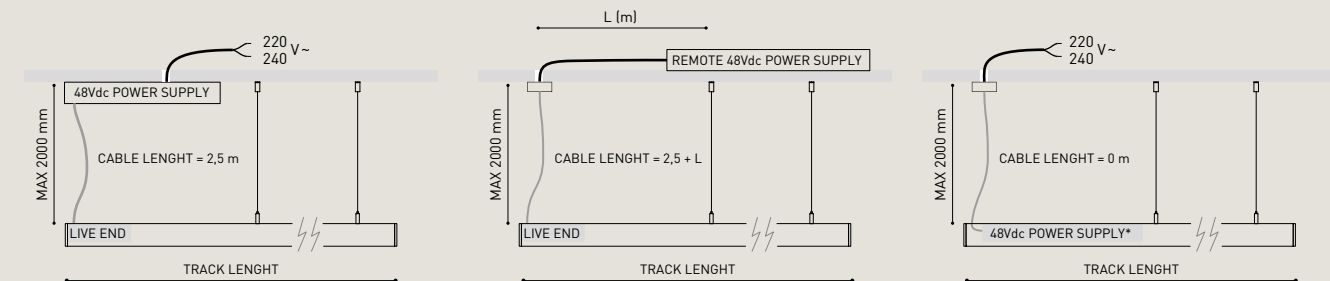

COLOUR | NT | WT | N

» PLEASE CONSULT

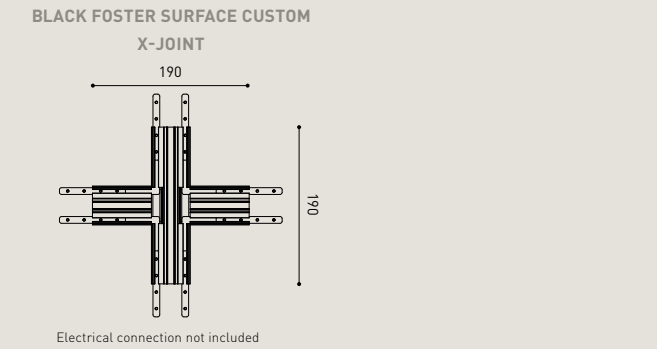
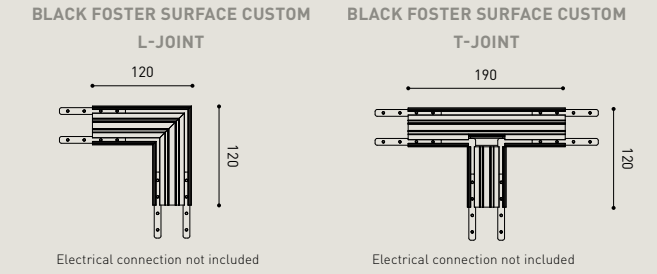

220V~ | *To be installed inside the track.

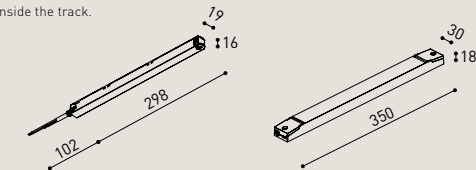

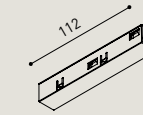
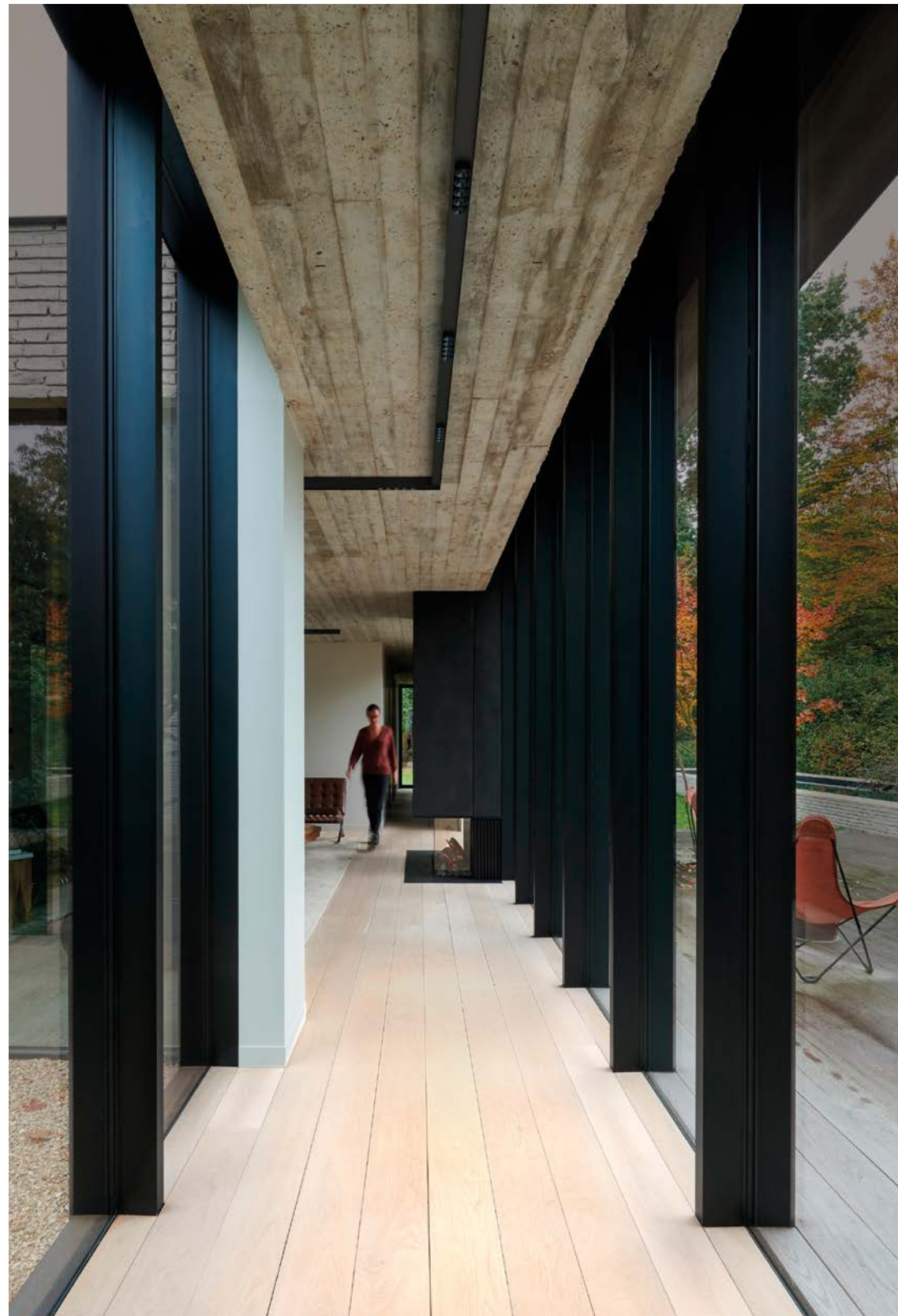

Live-End Connector 48V

A338-00-01- | N |

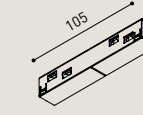

Central Connector 48V

A338-00-02- | N |

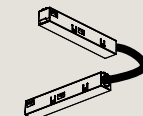

L-Joint Connector 48V

A338-00-12- | N |

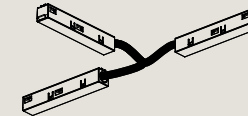

T-Joint Connector 48V

A450-00-07- | N |

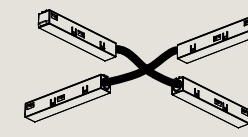

X-Joint Connector 48V

A450-00-08- | N |

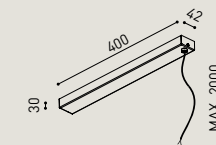

Wired Power Supply Case 48V

A338-00-25- | NT | WT | 150W NO DIM

A338-00-26- | NT | WT | 150W DIM

220V~
240V~
INCL



BLACK FOSTER Suspension Kit (2 units)

A450-00-09- | NT | WT |

Suggested mounting accessories quantities:
1000mm - 2 Pcs.
2000mm - 2 Pcs.
3000mm - 3 Pcs.

MAINS TRIMLESS



MAINS THICK TRIMLESS



STEEL CABLE TRIMLESS



SUSPENSION COMPONENTS

Wired Power Supply Case 48V

A338-00-25- | NT | WT | 150W NO DIM

A338-00-26- | NT | WT | 150W DIM

220V~
240V~
INCL

BLACK FOSTER Suspension Kit (2 units)

A450-00-09- | NT | WT |

Suggested mounting accessories quantities:
1000mm - 2 Pcs.
2000mm - 2 Pcs.
3000mm - 3 Pcs.

WIRE TRIMLESS ACCESSORIES

FEED

Mains Trimless*

A023-00-01- | W | N |



A023-00-02- | W | N |



A023-00-02- | W | N |

A023-00-02- | W | N |

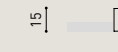
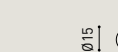

COLOUR | N ■ | W □ | NT ■ | WT □ |

* As many pieces as needed ACCORDING to your product



BLACK FOSTER Custom Surface

End A452-00-03- | N | W |



BLACK FOSTER Custom Surface

End Feed A452-00-04- | N | W |

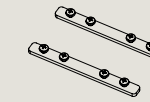

BLACK FOSTER Custom Surface

Straight Joiner A452-00-05

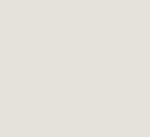
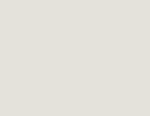

Suspension Feed Kit 48V

A338-00-16- | N | W | NO DIM

A338-00-17- | N | W | DIM

For remote power supply

A338-00-27- | N | W | NO DIM

A338-00-28- | N | W | DIM

For power supply inside the track

FASTENING

Steel Cable Trimless*

A023-00-05- | W | N |

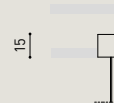
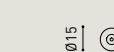

BLACK FOSTER CUSTOM
MICRO SURFACE

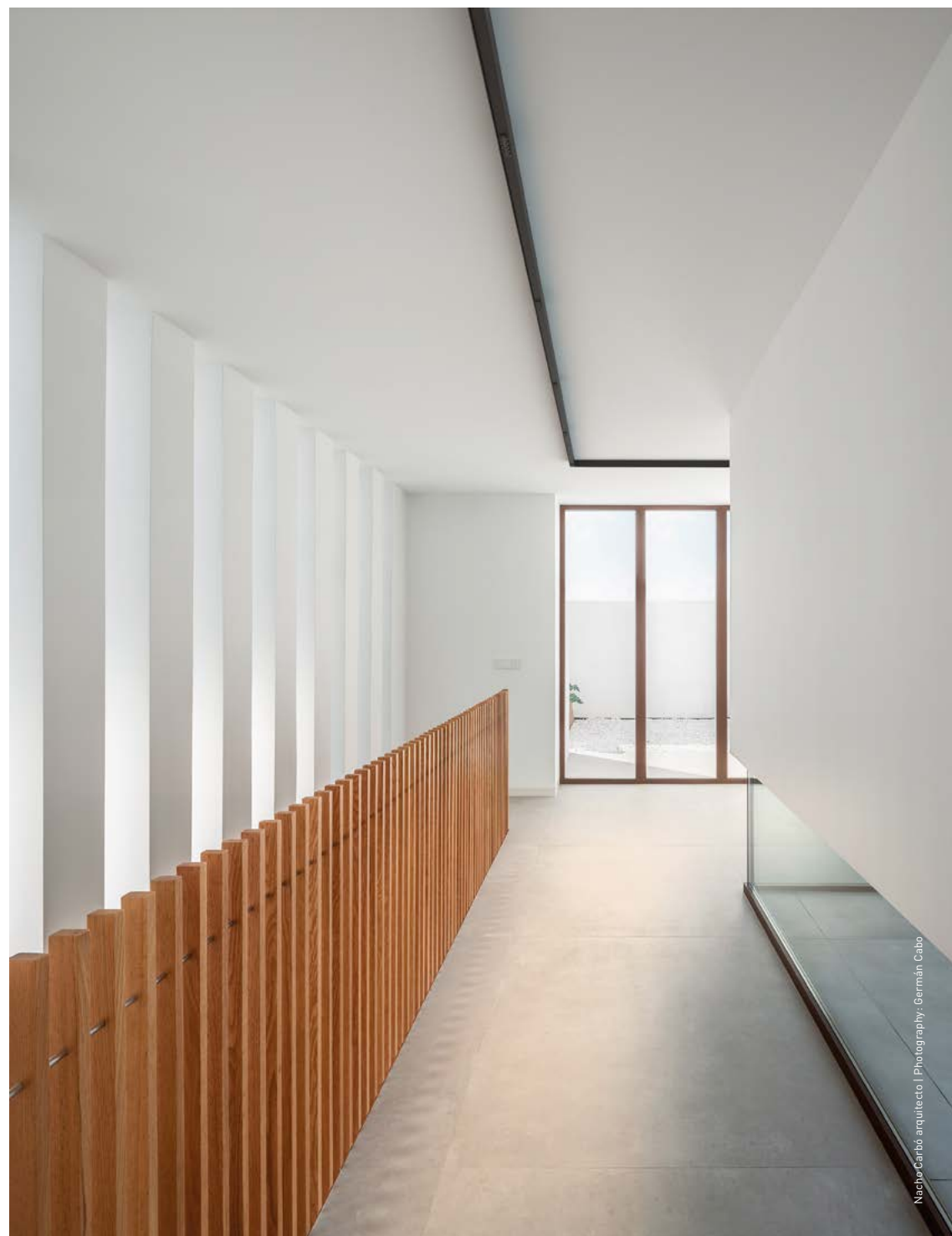

		P	CCT	I	Flux	LOR
BLACK FOSTER Micro Custom Module 3	A451-10- ① -0- N	4,2W	2700K	500mA	465Lm	87%
	A451-10- ① -1- N	4,2W	3000K	500mA	480Lm	87%
	A451-10- ① -2- N	4,2W	4000K	500mA	510Lm	87%
BLACK FOSTER Micro Custom Module 5	A451-20- ① -0- N	7W	2700K	500mA	775Lm	87%
	A451-20- ① -1- N	7W	3000K	500mA	800Lm	87%
	A451-20- ① -2- N	7W	4000K	500mA	850Lm	87%
BLACK FOSTER Micro Custom Module 10	A451-50- ① -0- N	14W	2700K	500mA	1550Lm	87%
	A451-50- ① -1- N	14W	3000K	500mA	1600Lm	87%
	A451-50- ① -2- N	14W	4000K	500mA	1700Lm	87%

48 V | IP20 | CRI>90 | L80B10 >60.000h



① *OPTIONS

1	No DIM
2	DIM DALI

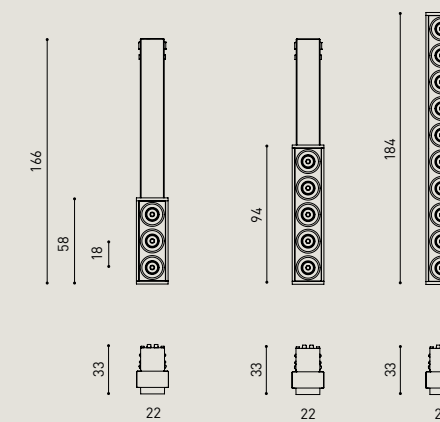

COLOUR | N ■ | MATERIAL | AL | ABS+PC

» PLEASE CONSULT

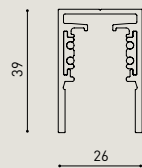

BLACK FOSTER Micro Custom Surface 1m	A450-01-00-	NT	WT
BLACK FOSTER Micro Custom Surface 2m	A450-02-00-	NT	WT
BLACK FOSTER Micro Custom Surface 3m	A450-03-00-	NT	WT



BLACK FOSTER Micro Custom Surface L-Joint	A450-04-00-	NT	WT
BLACK FOSTER Micro Custom Surface T-Joint	A450-05-00-	NT	WT
BLACK FOSTER Micro Custom Surface X-Joint	A450-06-00-	NT	WT



L

BLACK FOSTER Micro Custom Cover Gap 250	A450-01-00-	N	250mm
BLACK FOSTER Micro Custom Cover Gap 500	A450-02-00-	N	500mm
BLACK FOSTER Micro Custom Cover Gap 1000	A450-02-00-	N	1000mm

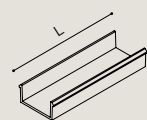

BLACK FOSTER MICRO SURFACE CUSTOM L-JOINT

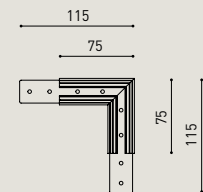

Electrical connection not included

BLACK FOSTER MICRO SURFACE CUSTOM T-JOINT

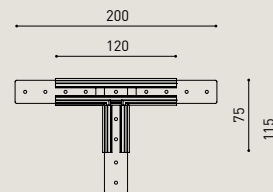

Electrical connection not included

BLACK FOSTER MICRO SURFACE CUSTOM X-JOINT

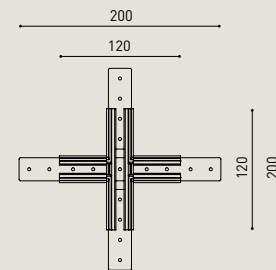

Electrical connection not included

P V D (A x B x C)

Constant Voltage LED POWER SUPPLY	0434-01-61*	N	100W	48V	198 x 16 x 19mm
	0434-01-62		150W	48V	350 x 30 x 18mm

220/240 V~ *To be installed inside the track.

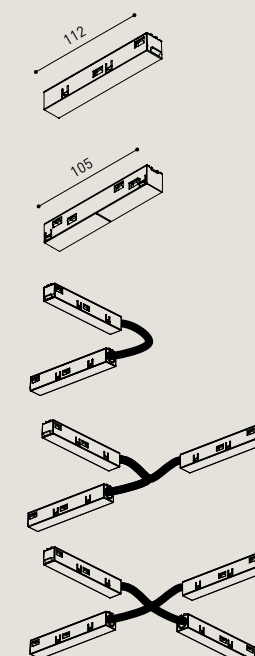
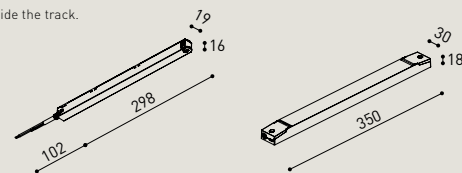

Live-End Connector 48V

A338-00-01- | N |

Central Connector 48V

A338-00-02- | N |

L-Joint Connector 48V

A338-00-12- | N |

T-Joint Connector 48V

A450-00-07- | N |

X-Joint Connector 48V

A450-00-08- | N |

BLACK FOSTER Micro Custom Surface

End A450-00-04- | N | W |

BLACK FOSTER Micro Custom Surface

End Feed A450-00-05- | N | W |

BLACK FOSTER Micro Custom Surface

Straight Joiner A450-00-06

SUSPENSION COMPONENTS

Wired Power Supply Case 48V

A338-00-25- | NT | WT | 150W NO DIM

A338-00-26- | NT | WT | 150W DIM

220/240 V~ INCL

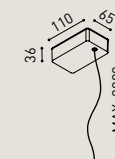

Suspension Feed Kit 48V

A338-00-16- | N | W | NO DIM

A338-00-17- | N | W | DIM

For remote power supply

A338-00-27- | N | W | NO DIM

A338-00-28- | N | W | DIM

For power supply inside the track

BLACK FOSTER Suspension Kit (2 units)

A450-00-09- | NT | WT |

Suggested mounting accessories quantities:
1000mm - 2 Pcs.
2000mm - 2 Pcs.
3000mm - 3 Pcs.

DROP VOLTAGE TABLE

POWER [W]	CABLE SECTION [mm ²]	CABLE LENGTH (m)			
		5	10	20	30
100	0,75	50	50	X	X
	1,5	50	50	40	25
150	0,75	40	15	X	X
	1,5	50	40	20	X

CABLE LENGTH

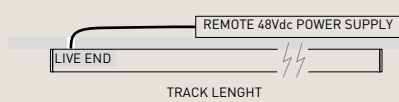

TRACK LENGTH

220/240 V~ CABLE LENGTH = 0m

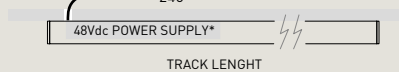

TRACK LENGTH

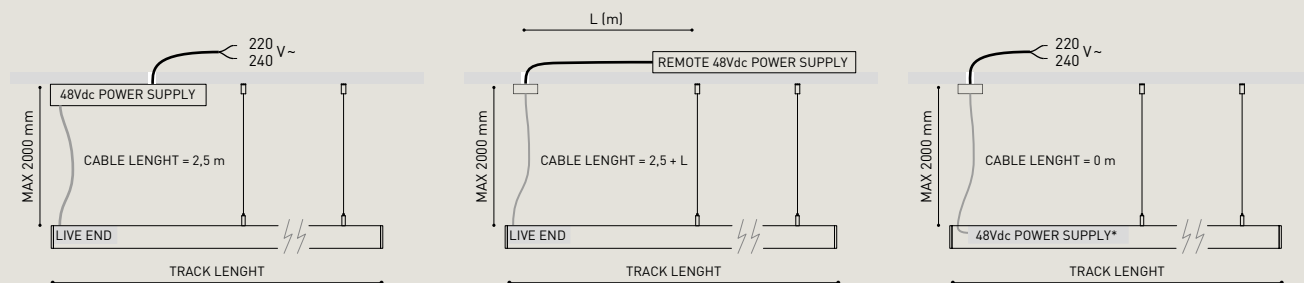

MAINS TRIMLESS



MAINS THICK TRIMLESS



STEEL CABLE TRIMLESS



WIRE TRIMLESS ACCESSORIES

FEED

Mains Trimless*

A023-00-01- | W | N | NO DIM

Mains Thick Trimless*

A023-00-02- | W | N | DIM

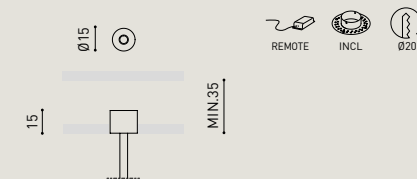

FASTENING

Steel Cable Trimless*

A023-00-05- | W | N |

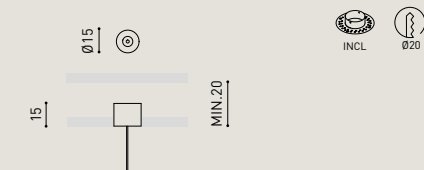

COLOUR | NT ■ | WT □ | N ■ |

COLOUR | N ■ | W □ | NT ■ | WT □ |

(((co))) » PLEASE CONSULT

* As many pieces as needed ACCORDING to your product

BLACK FOSTER
RECESSED

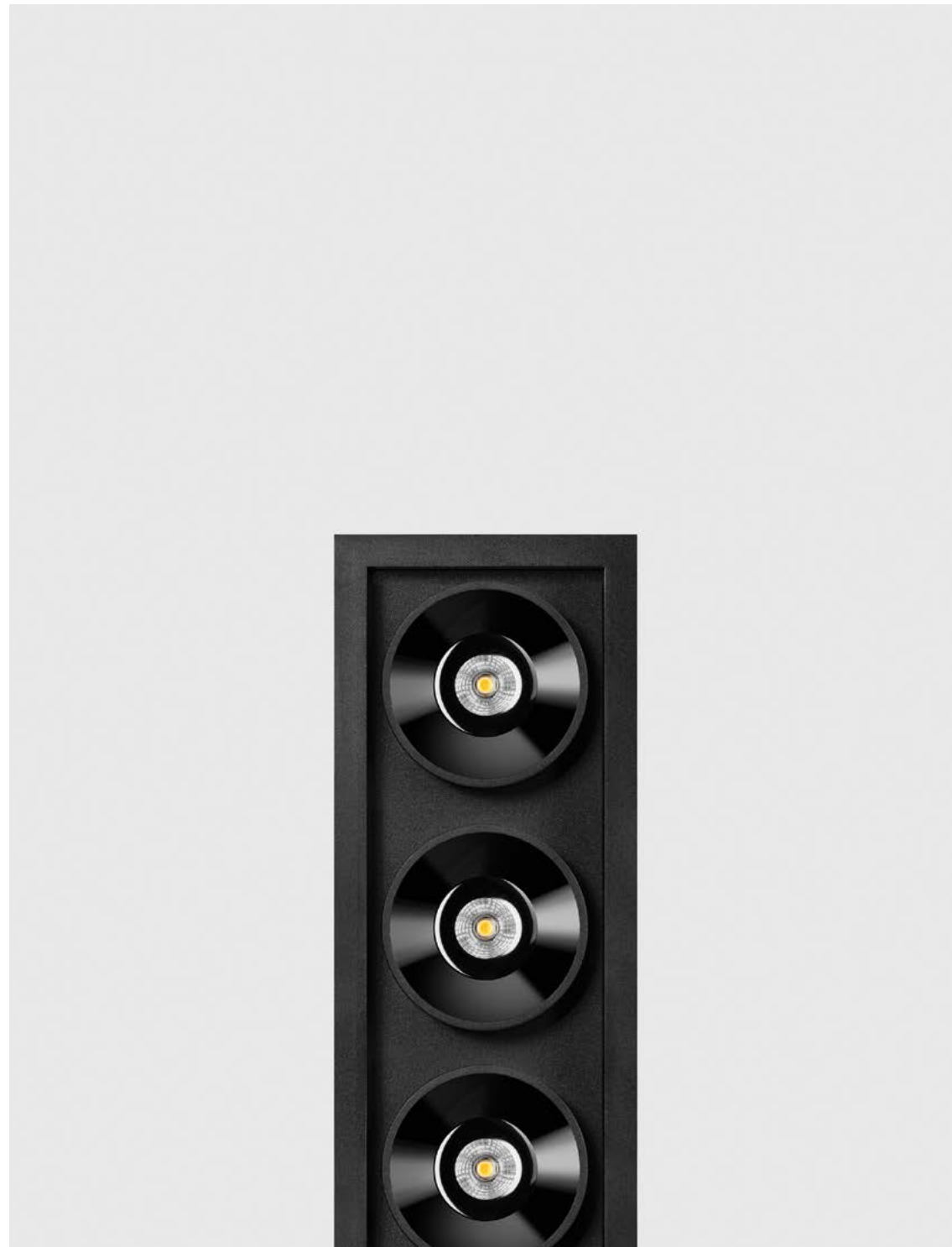

		P	CCT	I	Flux	
BLACK FOSTER Recessed 1	A319-1- ○ -10-	N WN NMG	2,1W	2700K	700mA	190Lm
	A319-1- ○ -11-	N WN NMG	2,1W	3000K	700mA	210Lm
	A319-1- ○ -12-	N WN NMG	2,1W	4000K	700mA	250Lm
	A319-1- ○ -40-	N WN NMG	2,1W	2700K	700mA	190Lm
	A319-1- ○ -41-	N WN NMG	2,1W	3000K	700mA	210Lm
	A319-1- ○ -42-	N WN NMG	2,1W	4000K	700mA	250Lm

220 V~ | IP20 | CRI>90 | L80B10 > 60.000 h

MacAdam Step 3 | OPTIONS* | INCL | 50 X 50 | UGR <19 | 38° / 19°

		P	CCT	I	Flux	
BLACK FOSTER Recessed 2	A319-2- ○ -0-	N WN NMG	4,2W	2700K	700mA	380Lm
	A319-2- ○ -1-	N WN NMG	4,2W	3000K	700mA	420Lm
	A319-2- ○ -2-	N WN NMG	4,2W	4000K	700mA	500Lm

220 V~ | IP20 | CRI>90 | L80B10 > 60.000 h

MacAdam Step 3 | OPTIONS* | INCL | 50 X 93 | UGR <19 | 38° / 19°

		P	CCT	I	Flux	
BLACK FOSTER Recessed 3	A319-3- ○ -0-	N WN NMG	6,3W	2700K	700mA	570Lm
	A319-3- ○ -1-	N WN NMG	6,3W	3000K	700mA	630Lm
	A319-3- ○ -2-	N WN NMG	6,3W	4000K	700mA	750Lm

220 V~ | IP20 | CRI>90 | L80B10 > 60.000 h

MacAdam Step 3 | OPTIONS* | INCL | 50 X 136 | UGR <19 | 38° / 19°

		P	CCT	I	Flux	
BLACK FOSTER Recessed 5	A319-4- ○ -0-	N WN NMG	10,5W	2700K	700mA	950Lm
	A319-4- ○ -1-	N WN NMG	10,5W	3000K	700mA	1050Lm
	A319-4- ○ -2-	N WN NMG	10,5W	4000K	700mA	1250Lm

220 V~ | IP20 | CRI>90 | L80B10 > 60.000 h

MacAdam Step 3 | OPTIONS* | INCL | 50 X 222 | UGR <19 | 38° / 19°

○	BEAM	LOR
0	38°	92%
1	19°	90%

⊞	*OPTIONS
1	No DIM
2	DIM Push
4	DIM DALI

DIM PHASE CUT PLEASE CONSULT

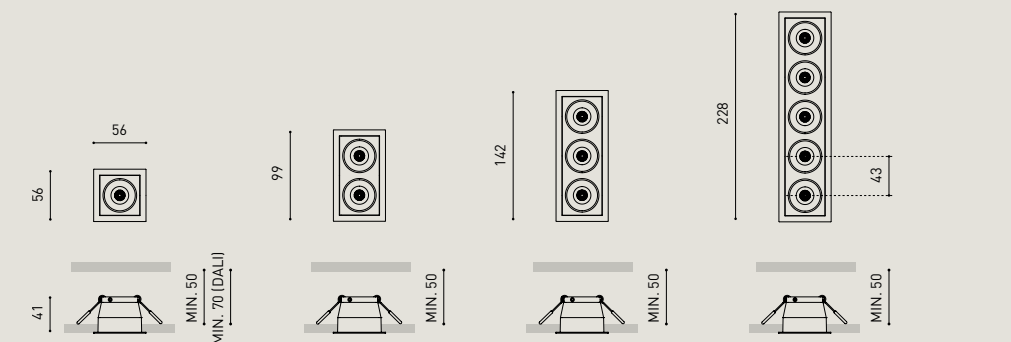

COLOUR | N ■ | WN ■ | NMG ■ | MATERIAL | AL | ABS+PC |

⊞ & ⊞ » PLEASE CONSULT

BLACK FOSTER ASYMMETRIC

RECESSED

		P	CCT	I	Flux	LOR
BLACK FOSTER Asymmetric Recessed 2	A374-20- ① -0- N WN	4,2W	2700K	700mA	380Lm	90%
	A374-20- ② -1- N WN	4,2W	3000K	700mA	420Lm	90%
	A374-20- ④ -2- N WN	4,2W	4000K	700mA	500Lm	90%

220V~ | 240V~ | IP20 | CRI>90 | L80B10 >60.000h



		P	CCT	I	Flux	LOR
BLACK FOSTER Asymmetric Recessed 3	A374-30- ① -0- N WN	6,3W	2700K	700mA	570Lm	90%
	A374-30- ② -1- N WN	6,3W	3000K	700mA	630Lm	90%
	A374-30- ④ -2- N WN	6,3W	4000K	700mA	750Lm	90%

220V~ | 240V~ | IP20 | CRI>90 | L80B10 >60.000h



		P	CCT	I	Flux	LOR
BLACK FOSTER Asymmetric Recessed 5	A374-40- ① -0- N WN	10,5W	2700K	700mA	950Lm	90%
	A374-40- ② -1- N WN	10,5W	3000K	700mA	1050Lm	90%
	A374-40- ④ -2- N WN	10,5W	4000K	700mA	1250Lm	90%

220V~ | 240V~ | IP20 | CRI>90 | L80B10 >60.000h

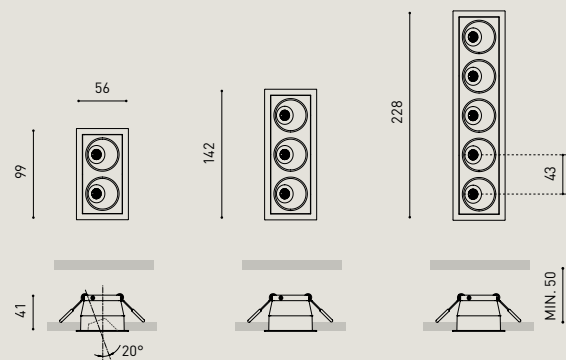

① *OPTIONS

- 1 No DIM
- 2 DIM Push
- 4 DIM DALI

DIM PHASE CUT PLEASE CONSULT

COLOUR | N ■ | WN ■ | MATERIAL | AL | ABS+PC

Ⓢ & Ⓜ » PLEASE CONSULT



BLACK FOSTER ASYMMETRIC

TRIMLESS

		P	CCT	I	Flux	LOR
BLACK FOSTER Asymmetric Trimless 2	A373-20- ① -0- N	4,2W	2700K	700mA	380Lm	90%
	A373-20- ① -1- N	4,2W	3000K	700mA	420Lm	90%
	A373-20- ① -2- N	4,2W	4000K	700mA	500Lm	90%

220V~ | 240V~ | IP20 | CRI>90 | L80B10 >60.000h



		P	CCT	I	Flux	LOR
BLACK FOSTER Asymmetric Trimless 3	A373-30- ① -0- N	6,3W	2700K	700mA	570Lm	90%
	A373-30- ① -1- N	6,3W	3000K	700mA	630Lm	90%
	A373-30- ① -2- N	6,3W	4000K	700mA	750Lm	90%

220V~ | 240V~ | IP20 | CRI>90 | L80B10 >60.000h



		P	CCT	I	Flux	LOR
BLACK FOSTER Asymmetric Trimless 5	A373-40- ① -0- N	10,5W	2700K	700mA	950Lm	90%
	A373-40- ① -1- N	10,5W	3000K	700mA	1050Lm	90%
	A373-40- ① -2- N	10,5W	4000K	700mA	1250Lm	90%

220V~ | 240V~ | IP20 | CRI>90 | L80B10 >60.000h



① *OPTIONS

1	No DIM
2	DIM Push
4	DIM DALI

DIM PHASE CUT PLEASE CONSULT

COLOUR | N ■ | MATERIAL | AL | ABS+PC |

PLASTERBOARD CEILING, MANDATORY THICKNESS 12,5mm. RECOMMENDED FOR INSTALLATIONS WHERE THE PROFILE CAN BE INSTALLED BEFORE THE FALSE PLASTERBOARD CEILING.

Ⓢ & Ⓜ » PLEASE CONSULT

		P	CCT	I	Flux	LOR
BLACK FOSTER Asymmetric Trimless 10	A373-50- ① -0- N	21W	2700K	700mA	1900Lm	90%
	A373-50- ① -1- N	21W	3000K	700mA	2100Lm	90%
	A373-50- ① -2- N	21W	4000K	700mA	2500Lm	90%

220V~ | 240V~ | IP20 | CRI>90 | L80B10 >60.000h



		P	CCT	I	Flux	LOR
BLACK FOSTER Asymmetric Trimless 15	A373-60- ① -0- N	31,5W	2700K	700mA	2850Lm	90%
	A373-60- ① -1- N	31,5W	3000K	700mA	3150Lm	90%
	A373-60- ① -2- N	31,5W	4000K	700mA	3750Lm	90%

220V~ | 240V~ | IP20 | CRI>90 | L80B10 >60.000h



① *OPTIONS

1	No DIM
2	DIM Push
4	DIM DALI

DIM PHASE CUT PLEASE CONSULT

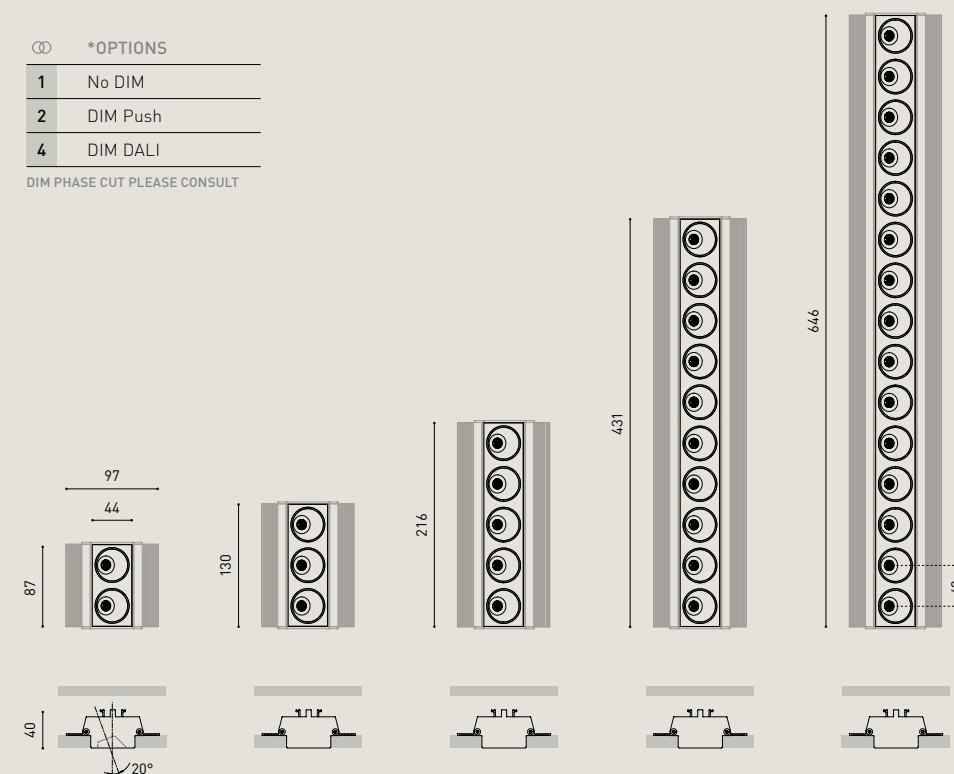

COLOUR | N ■ | MATERIAL | AL | ABS+PC |

PLASTERBOARD CEILING, MANDATORY THICKNESS 12,5mm. RECOMMENDED FOR INSTALLATIONS WHERE THE PROFILE CAN BE INSTALLED BEFORE THE FALSE PLASTERBOARD CEILING.

Ⓢ & Ⓜ » PLEASE CONSULT



BLACK FOSTER SURFACE

		P	CCT	I	Flux
BLACK FOSTER Surface 1	A320-1- ○ -10- WT NT WTMG NTMG	2,1W	2700K	700mA	190Lm
	A320-1- ○ -11- WT NT WTMG NTMG	2,1W	3000K	700mA	210Lm
	A320-1- ○ -12- WT NT WTMG NTMG	2,1W	4000K	700mA	250Lm

220 V~ | IP20 | CRI>90 | L80B10 >60.000h



		P	CCT	I	Flux
BLACK FOSTER Surface 2	A320-2- ○ -10- WT NT WTMG NTMG	4,2W	2700K	700mA	380Lm
	A320-2- ○ -11- WT NT WTMG NTMG	4,2W	3000K	700mA	420Lm
	A320-2- ○ -12- WT NT WTMG NTMG	4,2W	4000K	700mA	500Lm

220 V~ | IP20 | CRI>90 | L80B10 >60.000h

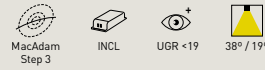

		P	CCT	I	Flux
BLACK FOSTER Surface 3	A320-3- ○ -10- WT NT WTMG NTMG	6,3W	2700K	700mA	570Lm
	A320-3- ○ -11- WT NT WTMG NTMG	6,3W	3000K	700mA	630Lm
	A320-3- ○ -12- WT NT WTMG NTMG	6,3W	4000K	700mA	750Lm

220 V~ | IP20 | CRI>90 | L80B10 >60.000h



○ BEAM	LOR
0	38° 92%
1	19° 90%

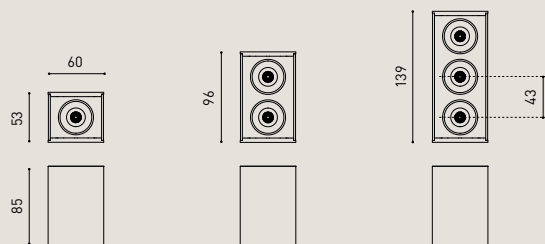

COLOUR | WT □ | NT ■ | WTMG □ | NTMG ■ | MATERIAL | AL | ABS+PC

"The Invisible Black" is only available for NT, NTMG & WTMG colours

		P	CCT	I	Flux
BLACK FOSTER Surface 5	A320-4- ○ -0- WT NT WTMG NTMG	10,5W	2700K	700mA	950Lm
	A320-4- ○ -1- WT NT WTMG NTMG	10,5W	3000K	700mA	1050Lm
	A320-4- ○ -2- WT NT WTMG NTMG	10,5W	4000K	700mA	1250Lm

220 V~ | IP20 | CRI>90 | L80B10 >60.000h



		P	CCT	I	Flux
BLACK FOSTER Surface 10	A320-5- ○ -0- WT NT WTMG NTMG	21W	2700K	700mA	1900Lm
	A320-5- ○ -1- WT NT WTMG NTMG	21W	3000K	700mA	2100Lm
	A320-5- ○ -2- WT NT WTMG NTMG	21W	4000K	700mA	2500Lm

220 V~ | IP20 | CRI>90 | L80B10 >60.000h



		P	CCT	I	Flux
BLACK FOSTER Surface 15	A320-6- ○ -0- WT NT WTMG NTMG	31,5W	2700K	700mA	2850Lm
	A320-6- ○ -1- WT NT WTMG NTMG	31,5W	3000K	700mA	3150Lm
	A320-6- ○ -2- WT NT WTMG NTMG	31,5W	4000K	700mA	3750Lm

220 V~ | IP20 | CRI>90 | L80B10 >60.000h



○ BEAM	LOR
0	38° 92%
1	19° 90%

⊗ *OPTIONS	
1	No DIM
2	DIM Push
4	DIM DALI

DIM PHASE CUT PLEASE CONSULT

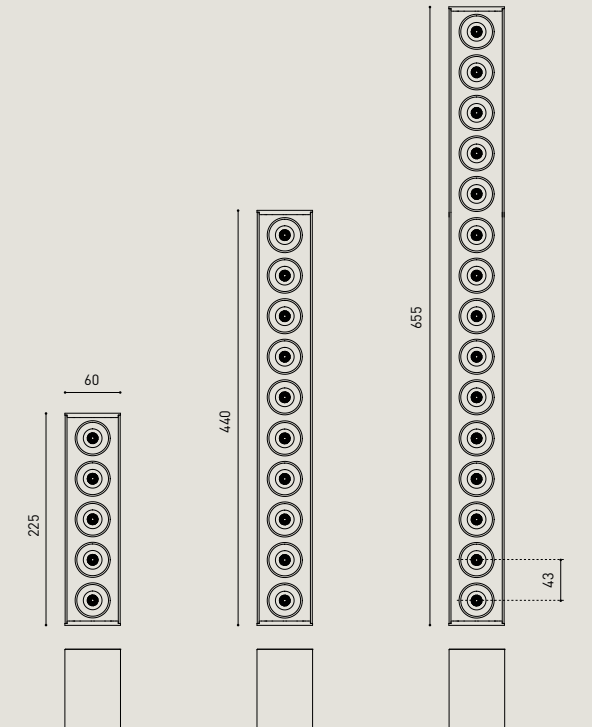

COLOUR | WT □ | NT ■ | WTMG □ | NTMG ■ | MATERIAL | AL | ABS+PC

"The Invisible Black" is only available for NT, NTMG & WTMG colours | OTHER DIM PLEASE CONSULT

⊗ » PLEASE CONSULT



BLACK FOSTER SUSPENSION

		P	CCT	I	Flux
BLACK FOSTER Suspension 1200	A321-1- ○ - ○ -0- WT NT WTMG NTMG	21W	2700K	700mA	1900Lm
	A321-1- ○ - ○ -1- WT NT WTMG NTMG	21W	3000K	700mA	2100Lm
	A321-1- ○ - ○ -2- WT NT WTMG NTMG	21W	4000K	700mA	2500Lm
BLACK FOSTER Suspension 1600	A321-2- ○ - ○ -0- WT NT WTMG NTMG	31,5W	2700K	700mA	2850Lm
	A321-2- ○ - ○ -1- WT NT WTMG NTMG	31,5W	3000K	700mA	3150Lm
	A321-2- ○ - ○ -2- WT NT WTMG NTMG	31,5W	4000K	700mA	3750Lm

220 V~ | IP20 | CRI>90 | L90B10 >60.000h

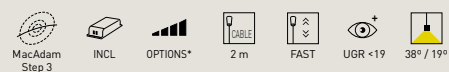

OPTIONAL ACCESSORIES

WIRE TRIMLESS Accessories

FEED

Mains Trimless

A023-00-01- | W | N | NO DIM On Board

Mains Thick Trimless

A023-00-02- | W | N | DALI | Push



FASTENING

Steel Cable Trimless

A023-00-05- | W | N | 2 Pcs. needed

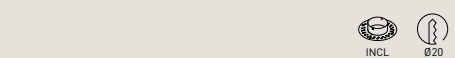

○	BEAM	LOR
0	38°	92%
1	19°	90%

○	*OPTIONS
1	No DIM
2	DIM DALI
3	DIM Push
5	DIM On Board

BLACK FOSTER SUSPENSION 1200

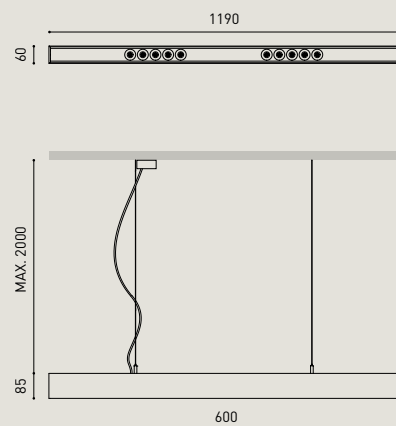

BLACK FOSTER SUSPENSION 1600

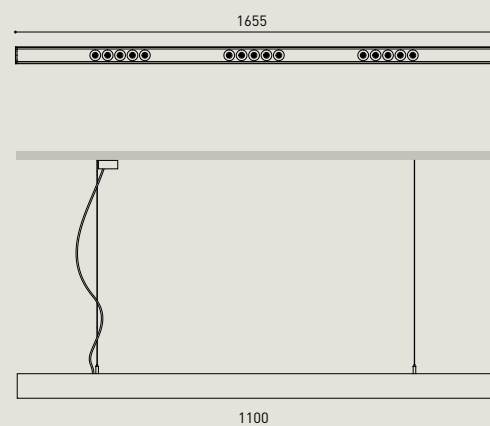

MAINS TRIMLESS



MAINS THICK TRIMLESS

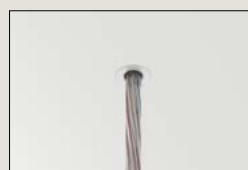

STEEL CABLE TRIMLESS



COLOUR | WT □ | NT ■ | WTMG □ | NTMG ■ | W □ | N ■ | MATERIAL | AL | ABS+PC

To achieve a homogeneous light distribution, a distance of 80 cm between the luminaire and the work surface is recommended.

((())) » PLEASE CONSULT



Glossary

P	Power		Chromatic stability: MacAdam Steps
CCT	Colour Temperature		Dimmable
I	Current intensity		Control gear not included
Flux	Gross luminous flux		Electronic equipment included
L	Length (in mm)		Fitting hole for recessed luminaires in mm
AL	Aluminium		Connected control gear
PC	Polycarbonate		Cable length
ABS	Acrylonitrile Butadiene Styrene		Quick adjustment for cable suspension
LOR	Lumen Output Ratio. Ratio between the output flux of the luminaire and the output flux of the light source		Control through bluetooth
IPXX	Sealing rating		Emergency lighting device
CRI	Color rendering index		Instalation type and light beam direction
	LED lamp		UGR (Unified Glare Rating) Visual comfort
	Power supply voltaje 220-240V		Made of
	CE marking		Tilting angle
	ENEC certified		Rotation angle
	Class II		Reflector
	Class III		

Colours

The lighting values indicated for each ref. code correspond to the results obtained from the tests carried out on the first mentioned colour of the list.

	N Matt black = RAL 9005 NT Textured black = RAL 9005
	B White = RAL 9016 WT Textured white = RAL 9016
	WN Textured white - Black WN RAL 9016 - RAL 9005
	G Gold = RAL 1036
	WTMG Textured white - Metallic Gold*
	NMG Matt black - Metallic Gold*
	NTMG Textured black - Metallic Gold*

*RAL not available. Paint of metallic nanoparticles.

Special LED

FOR COMMERCIAL PRODUCT SHOWCASING

For some of its products, Arkoslight offers the possibility to provide them with a special LED, designed to create an illumination focused on visually promoting goods or products for commercial purposes. It is a high chromaticity LED, capable of identifying the colour shades that produce a positive psychological perception of the illuminated object.

This special LED lighting source offers a much more attractive and intense colour range than a conventional LED, besides being much wider. Technically, this is possible thanks to a special LED setting that includes a « special saturation parameter », capable of highlighting the objects colours and materials in such a way that they seem more attractive within the visible light spectrum. To achieve this performance, in each case, the appropriate COB and specific phosphor coating are carefully selected.

ARKOSLIGHT®

Calle N · Pol. Ind. EL OLIVERAL
46394 Ribarroja del Turia · Valencia (Spain)
Tel. +34 961 667 207 · Fax +34 961 667 054
info@arkoslight.com · www.arkoslight.com
France: +33 182 885 200 · Italia: +39 02 9475 0007
Deutschland: +49 22 182 829 313



LIGHT&LIFE
— DESDE 1984 —