

Spotlights Downlights



Spotlights & Downlights

UNICO



44

recessed

ceiling

wall surface

wall recessed

SPIO



CAVO

**NEW →** 86

recessed

96

recessed

SASSO

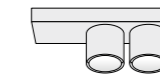
**NEW →** 108

recessed

semi-recessed

ceiling

ceiling

suspended

wall surface

SASSO PRO



MOVE IN



TWIST

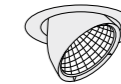

SPADO



168

recessed

NEW → 180

recessed

NEW → 194

recessed

200

recessed

SQUADRO

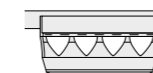
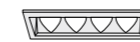

BO

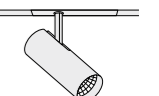
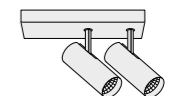

208

recessed

track

222

semi-recessed

surface

surface

track

VARO

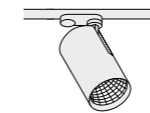

PABLO

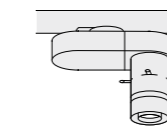

248

track

264

track

TULA



ARY

**NEW →** 280

suspended

288

suspended

TRACK 3-phase



300

recessed

surface

suspended

Shape the light

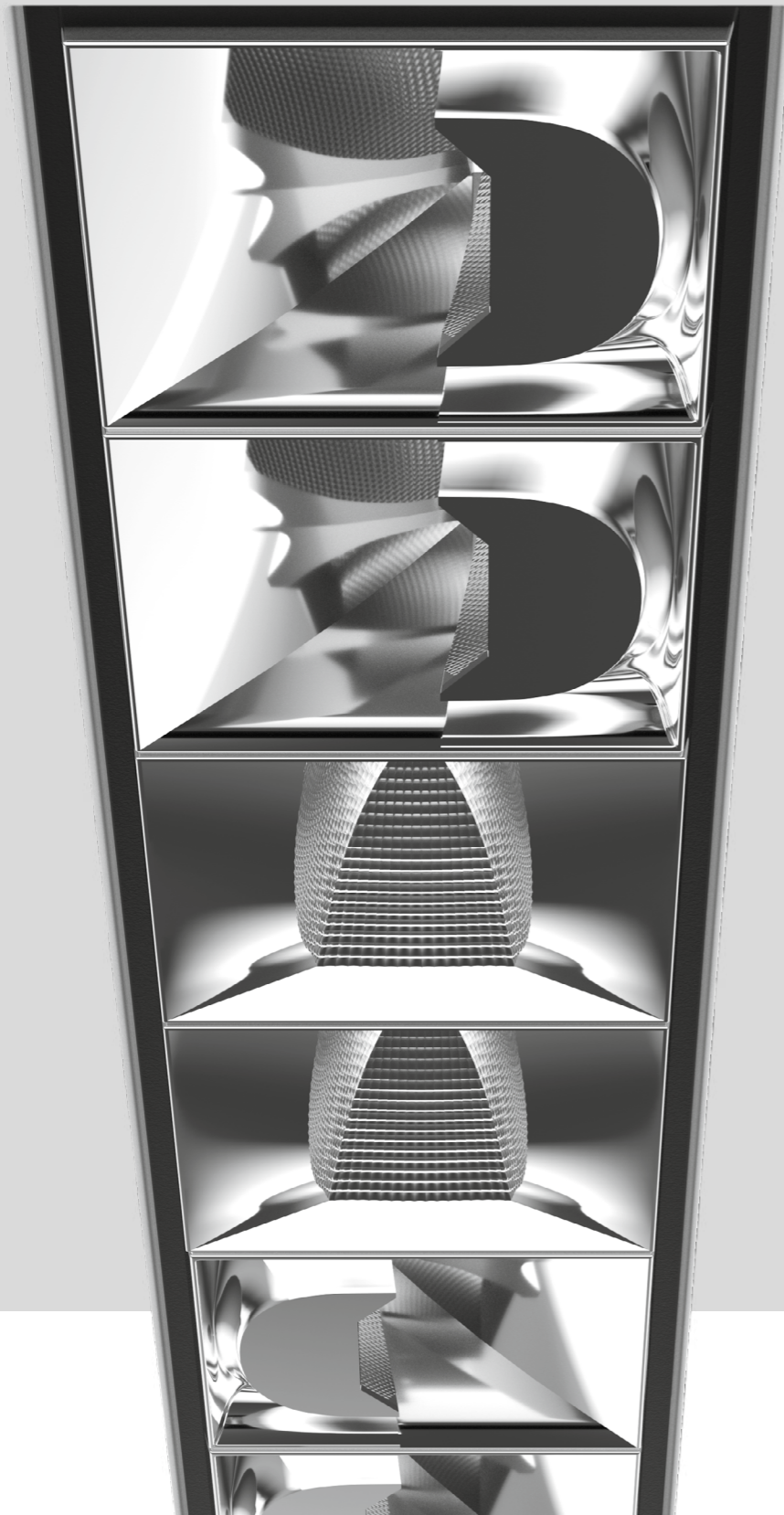

UNICO

EN With UNICO, XAL crafted a unique product built for flexibility. The luminaire offers a solution for every requirement and need. The luminaire can be shaped from five mounting options, seven shapes, eleven optics, two sensors, four colour temperatures and two control options. The intuitive UNICO configurator helps guide the flexible composition and selection of the different beam characteristics. A single luminaire has never offered this much planning freedom in professional lighting design.

DE Mit UNICO ist XAL ein Unikat in punkto Flexibilität gelungen. Die Leuchte bietet für jede Anforderung und jedes Bedürfnis eine Lösung. Aus fünf Montage-Optionen, sieben Formen, elf Optiken, zwei Sensoren, vier Farbtemperaturen und zwei Steuerungsmöglichkeiten kann die Leuchte individuell kombiniert werden. Der intuitive UNICO Konfigurator unterstützt bei der flexiblen Zusammenstellung und der Auswahl der verschiedenen Abstrahlcharakteristiken. Mehr planerische Freiheit hat es bei der professionellen Lichtplanung mit einer einzigen Leuchte nie gegeben.

Types

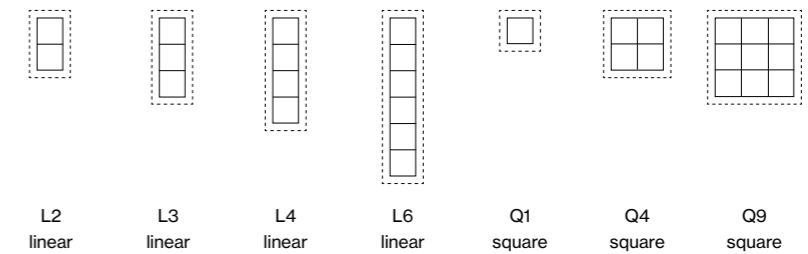

Mountings

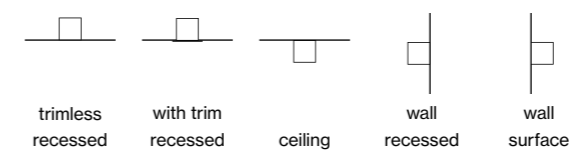

Light optics Sensors

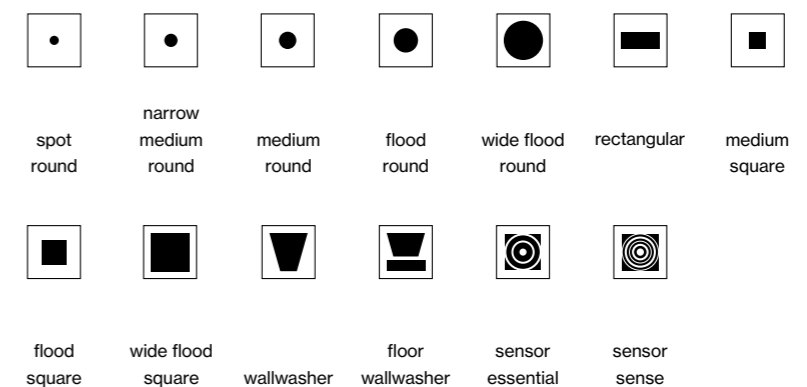

UNICO recessed



Installation housing

	Q1	Q4	Q9	L2
TYPE	with trim (white or black)	with trim (white or black)	with trim (white or black)	with trim (white or black)
CEILING THICKNESS	intermediate 2–25 mm	intermediate 2–25 mm	intermediate 2–25 mm	intermediate 2–25 mm
DIMENSION_{max}	63 × 63 mm	101 × 101 mm	138 × 138 mm	101 × 63 mm
CUTOUT DIMENSION	50 × 50 mm	90 × 90 mm	130 × 130 mm	90 × 50 mm
RECESS DEPTH	155 mm	110 mm	90 mm	140 mm

	Q1	Q4	Q9	L2
TYPE	trimless	trimless	trimless	trimless
CEILING THICKNESS	plasterboard 12/15/20/25	plasterboard 12/15/20/25	plasterboard 12/15/20/25	plasterboard 12/15/20/25
DIMENSION	50 × 50 mm	85 × 85 mm	125 × 125 mm	88 × 50 mm
CUTOUT DIMENSION	50 × 50 mm	90 × 90 mm	130 × 130 mm	90 × 50 mm
RECESS DEPTH	155 mm	110 mm	90 mm	140 mm

	L3	L4	L6
TYPE	with trim (white or black)	with trim (white or black)	with trim (white or black)
CEILING THICKNESS	intermediate 2–25 mm	intermediate 2–25 mm	intermediate 2–25 mm
DIMENSION_{max}	138 × 63 mm	176 × 63 mm	251 × 63 mm
CUTOUT DIMENSION	130 × 50 mm	165 × 50 mm	240 × 50 mm
RECESS DEPTH	110 mm	100 mm	100 mm

	L3	L4	L6
TYPE	trimless	trimless	trimless
CEILING THICKNESS	plasterboard 12/15/20/25	plasterboard 12/15/20/25	plasterboard 12/15/20/25
DIMENSION	125 × 50 mm	163 × 50 mm	238 × 50 mm
CUTOUT DIMENSION	130 × 50 mm	165 × 50 mm	240 × 50 mm
RECESS DEPTH	110 mm	100 mm	100 mm

Light optic

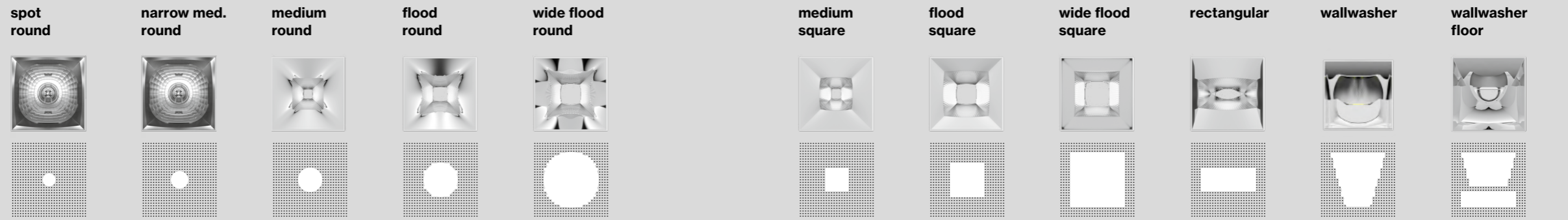

	spot round	narrow med. round	medium round	flood round	wide flood round	medium square	flood square	wide flood square	rectangular	wallwasher	wallwasher floor
LUMINOUS EFFICACY	up to 46 lm/W	up to 51 lm/W	up to 78 lm/W	up to 90 lm/W	up to 89 lm/W	up to 77 lm/W	up to 91 lm/W	up to 93 lm/W	up to 79 lm/W	up to 79 lm/W	up to 82 lm/W
LUMINOUS FLUX	179 lm, 190 lm	196 lm, 208 lm	300 lm, 319 lm	345 lm, 367 lm	342 lm, 363 lm	295 lm, 314 lm	351 lm, 373 lm	361 lm, 383 lm	305 lm, 324 lm	305 lm, 324 lm	318 lm, 338 lm
COLOUR TEMPERATURE	3000 K, 4000 K	3000 K, 4000 K	3000 K, 4000 K	3000 K, 4000 K	3000 K, 4000 K	3000 K, 4000 K	3000 K, 4000 K	3000 K, 4000 K	3000 K, 4000 K	3000 K, 4000 K	3000 K, 4000 K
COLOUR RENDERING INDEX	CRI ≥ 90	CRI ≥ 90	CRI ≥ 90	CRI ≥ 90	CRI ≥ 90	CRI ≥ 90	CRI ≥ 90	CRI ≥ 90	CRI ≥ 90	CRI ≥ 90	CRI ≥ 90

LIGHT DISTRIBUTION

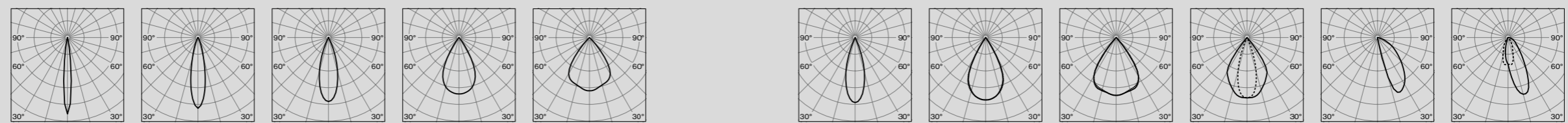

Create your own UNICO

unico.xal.com

EN XAL's UNICO is uniquely flexible. The luminaire offers a solution for every requirement. A UNICO can be flexibly assembled with eleven optics, two sensors and a selection of different light colours as well as Tunable White. XAL delivers this planning freedom with an intuitive online configurator. Solve concrete lighting concepts by creating a bespoke luminaire. unico.xal.com

DE Mit UNICO ist XAL ein Unikat in punkto Flexibilität gelungen. Für jede Anforderung bietet die Leuchte eine Lösung. Ein UNICO kann mit elf Optiken, zwei Sensoren und einer Auswahl verschiedener Lichtfarben sowie Tunable White flexibel zusammengestellt werden. Diese planerische Freiheit unterstützt XAL mit einem intuitiven Online-Konfigurator. Lösen Sie konkrete Beleuchtungskonzepte durch die flexible Zusammenstellung einer einzigartigen Leuchte: unico.xal.com

1. Define your shape

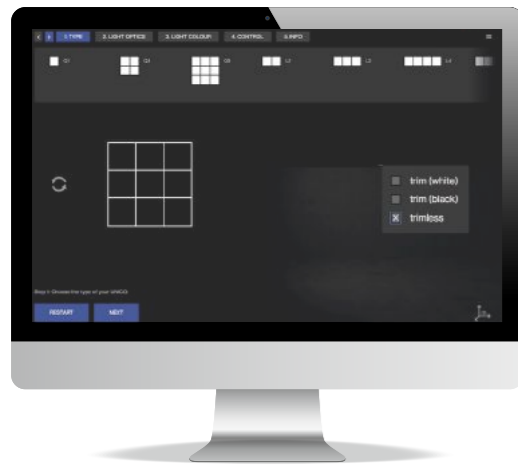

EN Select your preferred mounting type and then one of the seven shapes.

DE Wählen Sie eine passende Montageart und anschließend eine der sieben Formen aus.

2. Choose your light optic and colour



EN Combine the eleven light insets and two sensors. Then select the desired light temperature 2700K, 3000K, 4000K or Tunable White.

DE Kombinieren Sie die elf Lichteinsätze sowie zwei Sensoren und wählen Sie die passende Lichttemperatur 2700K, 3000K, 4000K oder Tunable White, beliebig nach Ihren Anforderungen.

3. Control

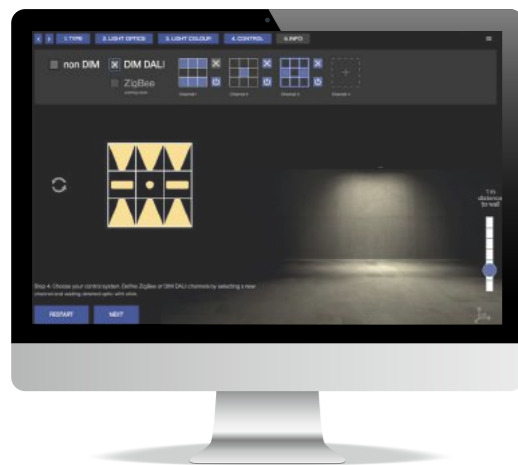

EN The configurator helps you set up a maximum of four control channels.

DE Mit Hilfe des Konfigurators können Sie bis zu vier Steuerungskanäle einrichten.

4. Info

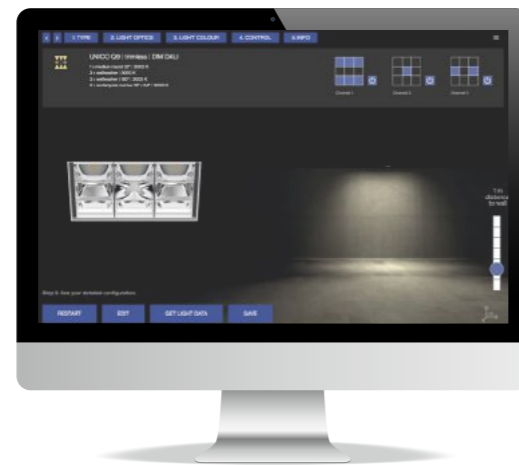

EN Get an overview of your configured UNICO. You can download all the specifications as a datasheet.

DE Verschaffen Sie sich einen Überblick über Ihren konfigurierten UNICO. Zusätzlich haben Sie die Möglichkeit sich alle Informationen in Form eines Datenblattes herunterzuladen.

One luminaire – four channels – various light scenes

EN Use the online configurator and address concrete lighting concepts by creating a bespoke luminaire. Assign each optic in a UNICO to one of up to four control channels. Each of the four channels can then be dimmed and controlled separately. Control is via DALI-2. Just one luminaire can create custom lighting scenarios for every application. There has never been more freedom in professional lighting design delivered by a single luminaire.

DE Nutzen Sie den Online-Konfigurator um konkrete Beleuchtungskonzepte durch die flexible Zusammenstellung der Optiken umzusetzen. Weisen Sie jede Optik in einer UNICO einem der bis zu vier Steuerungskanäle zu. Jeder der vier Kanäle kann dann separat gedimmt und angesteuert werden. Mit nur einer Leuchte realisieren Sie so für jede Anwendung individuelle Lichtszenarien. Die Steuerung erfolgt via DALI-2. Mehr Freiheit hat es bei der professionellen Lichtplanung mit einer einzigen Leuchte nie gegeben.

Light scene 1 wall

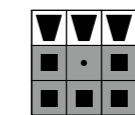
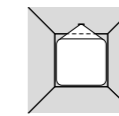

3 x wallwasher



Light scene 2 wall + floor

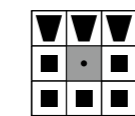
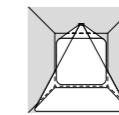

3 x wallwasher
5 x flood square



Light scene 3 floor

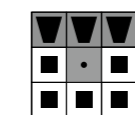
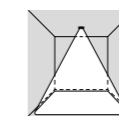

5 x flood square



Light scene 4 spots

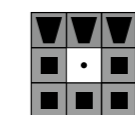
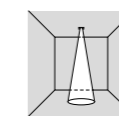

1 x spot round



92.2 quadrillion possibilities

EN The luminaire can be customised from five mounting options, seven shapes, eleven light insets, two sensors, four colour temperatures, and three control options. The downlight optics for generating round or angular light projections are available with different beam characteristics. There are also rectangular downlights and wallwasher optics for wall or wall / floor lighting. Highly glare-free versions (UGR ≤ 19) are ideal for use at computer workstations. Dedicated sensors help adjust the lighting according to daylight and room activity. In addition, the reflectors are available in the colours chrome, black, and gold. Values such as temperature, air quality, and noise levels can be recorded. This delivers valuable knowledge about the conditions of your premises.

DE Aus fünf Montageoptionen, sieben Formen, elf Lichteinsätzen, zwei Sensoren, vier Farbtemperaturen und drei Steuerungsmöglichkeiten kann die Leuchte individuell kombiniert werden. Die Downlight-Optiken zur Generierung runder oder eckiger Lichtprojektionen gibt es mit unterschiedlichen Abstrahlcharakteristiken. Zusätzlich gibt es rechteckige Downlights und Wallwasher-Optiken für Wand- oder Wand / Boden-Beleuchtung. Hochentblendete Versionen (UGR ≤ 19) sind ideal für den Einsatz an Bildschirmarbeitsplätzen. Zudem sind die Reflektoren in den Farben Chrome, Schwarz und Gold verfügbar. Spezielle Sensoren ermöglichen es die Beleuchtung an Tageslicht und Raumaktivität anzupassen, sowie Werte wie Temperatur, Luftqualität und Geräuschpegel zu erfassen. Hiermit lassen sich wertvolle Erkenntnisse über die Umgebungsbedingungen Ihrer Räumlichkeiten gewinnen.



Q1 trimless

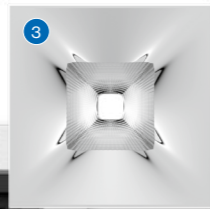
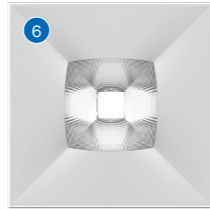

L3 trimless tunable white

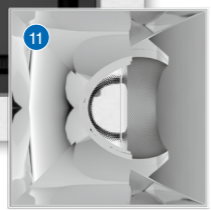
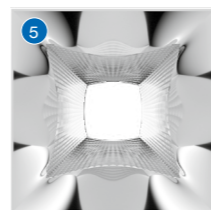
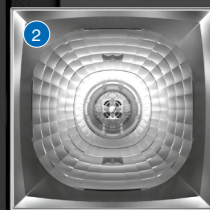
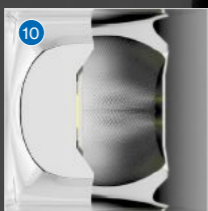
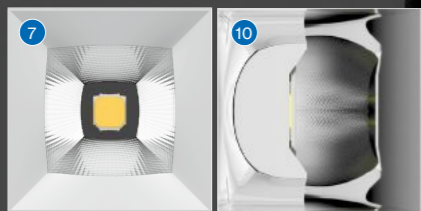

Q9 with trim

11 light optics and 2 sensors

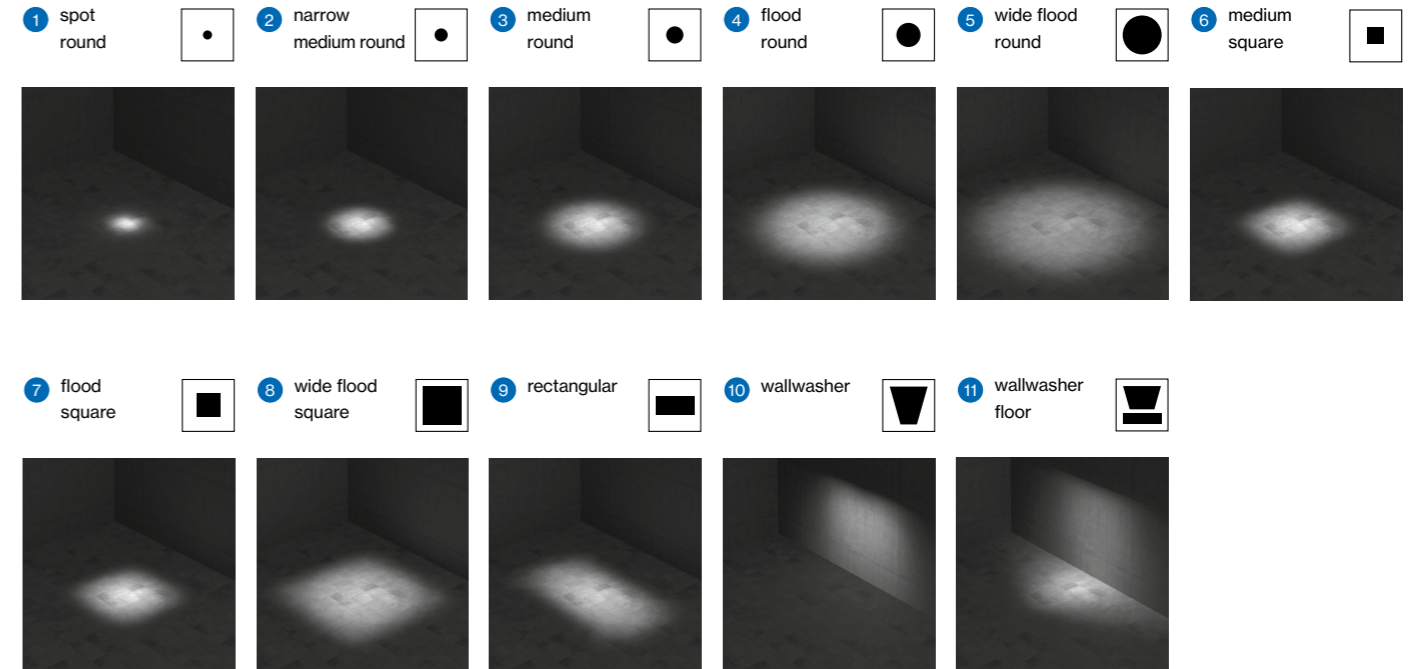

Sensors

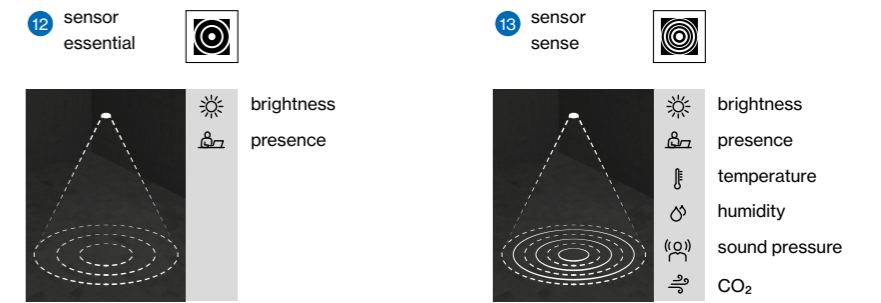

Precision cut-off

EN XAL Light optics deliver the latest development in the field of micro-faceted reflector technology. Architects and lighting planners have entirely new design options thanks to clearly defined contrasts and maximised efficiency. Compared with conventional optics, XAL Light optics offer, with the same beam angle, a clearly defined light cone break with minimal stray light at the edges.

DE Mit XAL Light optics bietet XAL die neueste Entwicklung auf dem Gebiet der mikro-facettierten Reflektortechnologie. Für ArchitektInnen und LichtplanerInnen ergeben sich dank klar definierter Kontraste bei gleichzeitig maximierter Effizienz völlig neue Gestaltungsmöglichkeiten. Verglichen mit konventionellen Optiken bieten XAL Light optics bei gleichem Abstrahlwinkel einen klar begrenzten Lichtkegelabriss mit wenig Streulicht im Randbereich.

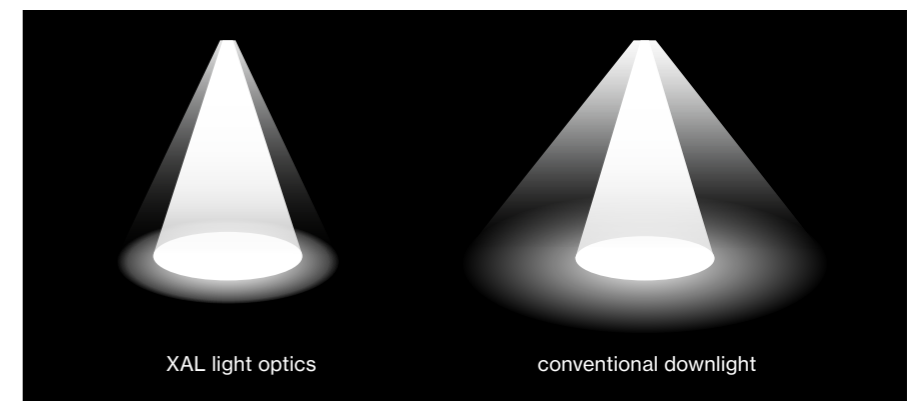
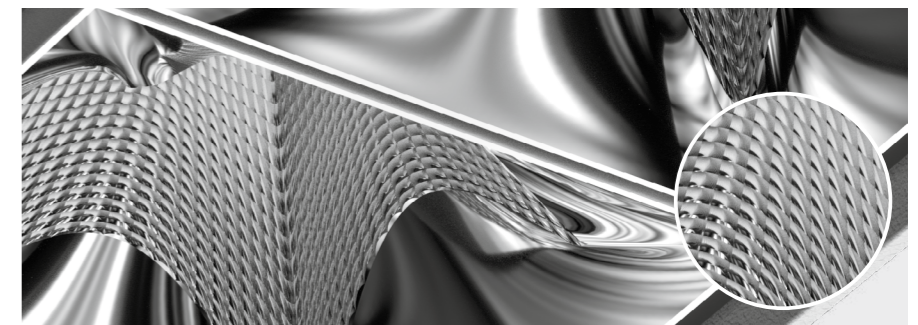

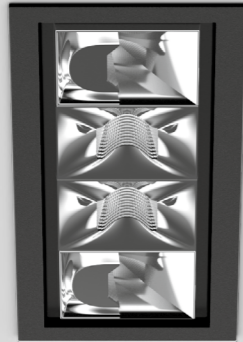

UNICO linear recessed

EN Rectangular recessed multi-downlight made of die-cast aluminium; equipped with two (L2) / three (L3) / four (L4) / six (L6) individually selectable or pre-specified, customised light elements; installation without tools in mounting set with ball catch system; easy electrical installation by means of reverse polarity protected plug-in connections; suitable for ceiling thickness of 2-25 mm; surface powder coated; installation possible in different housings; high-quality reflector with micro-faceted, aluminium-vaporised surface; precise radiation characteristic with different symmetrical light distributions; or with asymmetric light distribution; energy-efficient high power LEDs with very good colour rendering; clank-free

DE Rechteckiger Einbau-Multi-Downlight aus Aluminiumdruckguss; bestückt mit zwei (L2) / drei (L3) / vier (L4) / sechs (L6) individuell wählbaren oder fix definierten, anwendungsspezifischen Optiken; werkzeuglose Montage im Montageset durch Kugelschnappsystem; einfache elektrische Montage durch verpolungssichere Steckverbindung; geeignet für Deckenstärken von 2-25 mm; Oberfläche pulverbeschichtet; Einbau in unterschiedlichen Gehäusen möglich; hochwertiger Reflektor mit mikrofacettierter, aluminiumbedampfter Oberfläche; präzise Abstrahlcharakteristik mit unterschiedlichen symmetrischen Lichtverteilungen; oder mit asymmetrischer Lichtverteilung; energieeffiziente High-Power-LEDs mit sehr guter Farbwiedergabe; klirrfrei

Quickinfo

2700 K, 3000 K, 4000 K
 CRI ≥ 90, 3 SDCM
 UGR ≤ 19 / 65° ≤ 1500 cd/m²
 L2 up to 98 lm/W
 L3 up to 99 lm/W
 L4 up to 112 lm/W
 L6 up to 112 lm/W
 L90 @ 50 000 h
 non DIM, DALI-2

Types

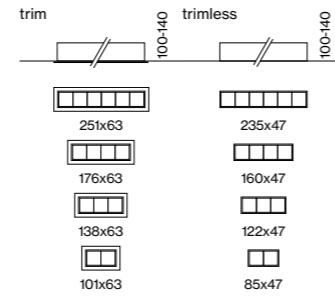

Colours



Light optics

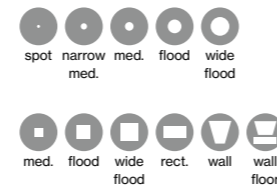

DiiA® standards
251, 252, 253

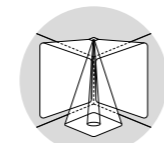

one luminaire multiple scenes



plug/socket connector

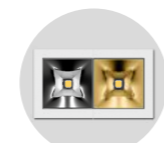

black & gold reflector

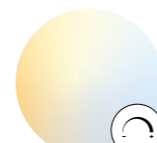

tunable white 2700-5000K

Order options

COLOUR TEMPERATURE	
2700 K	4
3000 K	5
4000 K	6

CONTROL	
non DIM	1
DALI-2	3

LIGHT OPTIC	
spot round (UGR ≤ 10)	K
narrow medium round (UGR ≤ 10)	N
medium round (UGR ≤ 10)	B
medium square (UGR ≤ 10)	E
flood round (UGR ≤ 16)	C
flood square (UGR ≤ 19)	F
wide flood round	D
wide flood square	G

MATERIAL COLOUR	
○ traffic white RAL 9016	W
● jet black RAL 9005	B

LIGHT OPTIC COLOUR	
chrome reflector	0
black reflector*	B

*not available for spot round, narrow medium round and wallwasher

Options on request

COLOUR TEMPERATURE	
tunable white 2700-5000K	
DALI-2 DT8	

LIGHT OPTIC COLOUR	
gold reflector	

MOUNTING SET	
acoustic soft ceilings	

Product configurator



Create your own UNICO PRO
unico.xal.com

Planning information

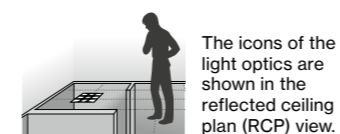

The icons of the light optics are shown in the reflected ceiling plan (RCP) view.

UNICO L2 basic recessed

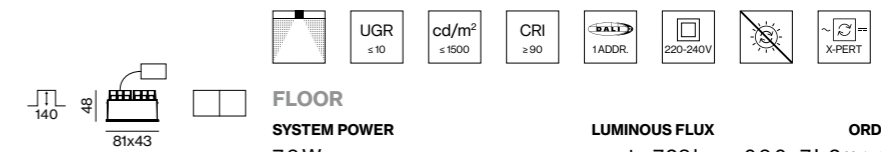

FLOOR	SYSTEM POWER	LUMINOUS FLUX	ORDER CODE
	7.9 W	up to 723 lm	090-7L2::▲0■21

choose one light optic ▲ from the options on the left depending on your room needs

WALL	SYSTEM POWER	LUMINOUS FLUX	ORDER CODE
2x wallwasher	7.9 W	611 lm	090-7L2::▲A022

CORRIDOR	SYSTEM POWER	LUMINOUS FLUX	ORDER CODE
2x rectangular	7.9 W	610 lm	090-7L2::▲R0■21

WALL + FLOOR	SYSTEM POWER	LUMINOUS FLUX	ORDER CODE
2x wallwasher floor	7.9 W	638 lm	090-7L2::▲W0■22

UNICO L3 basic recessed

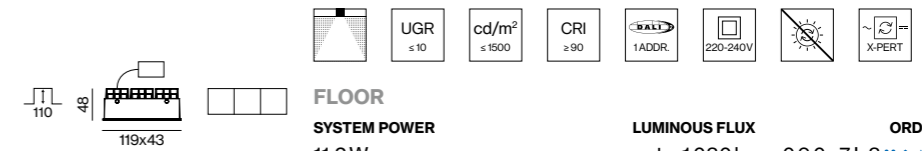

FLOOR	SYSTEM POWER	LUMINOUS FLUX	ORDER CODE
	11.2 W	up to 1030 lm	090-7L3::▲0■21

choose one light optic ▲ from the options on the left depending on your room needs

WALL	SYSTEM POWER	LUMINOUS FLUX	ORDER CODE
3x wallwasher	11.2 W	872 lm	090-7L3::▲A021

Accessories

MOUNTING SET WITH TRIM for intermediate ceilings 2-25 mm			
TYPE	L-W-H (mm)	CUTOUT (mm)	ORDER CODE
L2	101-63-30	90-50	090-7L2020■
L3	138-63-30	130-50	090-7L3020■

TRIMLESS MOUNTING SET for installation in plasterboard ceilings 12.5/15/20/25 mm			
TYPE	L-W-H (mm)	CUTOUT (mm)	ORDER CODE
L2	88-50-47	90-50	090-7L20100
L3	125-50-47	130-50	090-7L30100

THROUGH WIRING CONNECTION BOX			
TYPE	L-W-H (mm)	ORDER CODE	
non DIM cable ø 4-12 mm	105-58-30	005-2531110	
DALI cable ø 4-12 mm	105-58-30	005-2551110	

LUMINOUS FLUX value calculated for 3000K, CRI ≥ 90, colour white, reflector chrome 2700K -6%, 4000K +7%

← back

Order options

COLOUR TEMPERATURE

2700K	4
3000K	5
4000K	6

CONTROL

non DIM	1
DALI-2	3

LIGHT OPTIC

spot round (UGR≤10)	K
narrow medium round (UGR≤10)	N
medium round (UGR≤10)	B
medium square (UGR≤10)	E
flood round (UGR≤16)	C
flood square (UGR≤19)	F
wide flood round	D
wide flood square	G

MATERIAL COLOUR

○ traffic white RAL 9016	W
● jet black RAL 9005	B

LIGHT OPTIC COLOUR

chrome reflector	0
black reflector*	B

*not available for spot round, narrow medium round and wallwasher

Options on request

COLOUR TEMPERATURE

tunable white 2700–5000K
DALI-2 DT8

LIGHT OPTIC COLOUR

gold reflector

MOUNTING SET

acoustic soft ceilings

Product configurator



Create your own UNICO PRO

unico.xal.com

Planning information

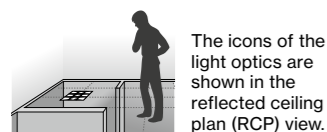

The icons of the light optics are shown in the reflected ceiling plan (RCP) view.

UNICO L4 basic recessed



FLOOR

SYSTEM POWER	LUMINOUS FLUX	ORDER CODE
13.9W	up to 1450lm	090-7L4::▲0■21

choose one light optic ▲ from the options on the left depending on your room needs



WALL

4x wallwasher

SYSTEM POWER	LUMINOUS FLUX	ORDER CODE
13.9W	1220lm	090-7L4::◆A0021



WALL + FLOOR

4x wallwasher floor

SYSTEM POWER	LUMINOUS FLUX	ORDER CODE
13.9W	1280lm	090-7L4::◆W0■22

Accessories

MOUNTING SET WITH TRIM

for intermediate ceilings 2–25mm

TYPE	L-W-H (mm)	CUTOUT (mm)	ORDER CODE
L4	176-63-30	165-50	090-7L4020

TRIMLESS MOUNTING SET

for installation in plasterboard ceilings 12.5/15/20/25mm

TYPE	L-W-H (mm)	CUTOUT (mm)	ORDER CODE
L4	163-50-47	165-50	090-7L40100

THROUGH WIRING CONNECTION BOX

TYPE	L-W-H (mm)	ORDER CODE
non DIM cable ø4–12mm	105-58-30	005-2531110
DALI cable ø4–12mm	105-58-30	005-2551110

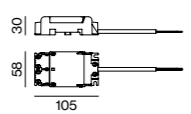
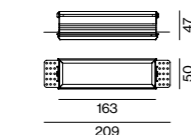
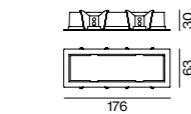
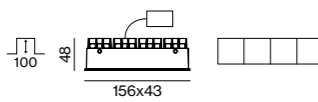

Order options

COLOUR TEMPERATURE

2700K	4
3000K	5
4000K	6

CONTROL

non DIM	1
DALI-2	3

LIGHT OPTIC

spot round (UGR≤10)	K
narrow medium round (UGR≤10)	N
medium round (UGR≤10)	B
medium square (UGR≤10)	E
flood round (UGR≤16)	C
flood square (UGR≤19)	F
wide flood round	D
wide flood square	G

MATERIAL COLOUR

○ traffic white RAL 9016	W
● jet black RAL 9005	B

LIGHT OPTIC COLOUR

chrome reflector	0
black reflector*	B

*not available for spot round, narrow medium round and wallwasher

Options on request

COLOUR TEMPERATURE

tunable white 2700–5000K
DALI-2 DT8

LIGHT OPTIC COLOUR

gold reflector

MOUNTING SET

acoustic soft ceilings

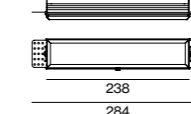
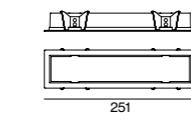
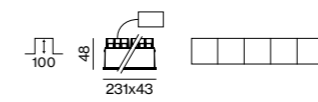

UNICO L6 basic recessed

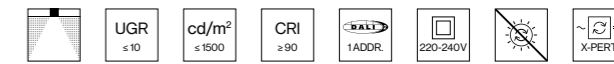

FLOOR

SYSTEM POWER	LUMINOUS FLUX	ORDER CODE
19.8W	up to 2060lm	090-7L6::▲0■21

choose one light optic ▲ from the options on the left depending on your room needs



WALL

6x wallwasher

SYSTEM POWER	LUMINOUS FLUX	ORDER CODE
19.8W	1740lm	090-7L6::◆A0021



CORRIDOR

6x rectangular

SYSTEM POWER	LUMINOUS FLUX	ORDER CODE
19.8W	1740lm	090-7L6::◆R0■21



WALL + FLOOR

6x wallwasher floor

SYSTEM POWER	LUMINOUS FLUX	ORDER CODE
19.8W	1820lm	090-7L6::◆W0■21

Accessories

MOUNTING SET WITH TRIM

for intermediate ceilings 2–25mm

TYPE	L-W-H (mm)	CUTOUT (mm)	ORDER CODE
L6	251-63-30	240-50	090-7L6020

TRIMLESS MOUNTING SET

for installation in plasterboard ceilings 12.5/15/20/25mm

TYPE	L-W-H (mm)	CUTOUT (mm)	ORDER CODE
L6	238-50-47	240-50	090-7L60100

THROUGH WIRING CONNECTION BOX

TYPE	L-W-H (mm)	ORDER CODE
non DIM cable ø4–12mm	105-58-30	005-2531110
DALI cable ø4–12mm	105-58-30	005-2551110

LUMINOUS FLUX value calculated for 3000K, CRI≥90, colour white, reflector chrome 2700K -6%, 4000K +7%

LUMINOUS FLUX value calculated for 3000K, CRI≥90, colour white, reflector chrome 2700K -6%, 4000K +7%



West Tower
Manchester, UK – by SimpsonHaugh with
lighting design by Troup, Bywaters & Anders





Penthouse Wörthersee
Carinthia, AT – by ROOMS GmbH



← back

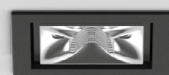
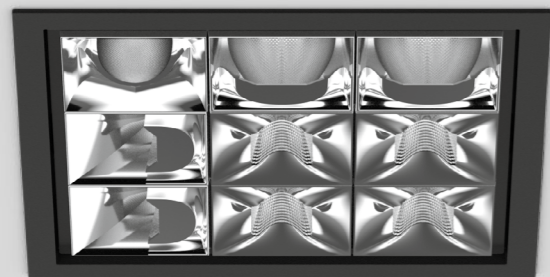

UNICO square

recessed

EN Square recessed multi-downlight made of die-cast aluminium; equipped with one (Q1) / four (Q4) / nine (Q9) individually selectable or pre-specified, customised light element(s); or with a sensor; installation without tools in mounting set with ball catch system; easy electrical installation by means of reverse polarity protected plug-in connections; suitable for ceiling thickness of 2-25 mm; surface powder coated; installation possible in different housings; high-quality reflector with micro-faceted, aluminum-vaporised surface; precise radiation characteristic with different symmetrical light distributions; or with asymmetric light distribution; energy-efficient high power LEDs with very good colour rendering; clank-free

DE Quadratischer Einbau-Multi-Downlight aus Aluminiumdruckguss; bestückt mit einer (Q1) / vier (Q4) / neun (Q9) individuell wählbaren oder fix definierten, anwendungsspezifischen Optik(en); oder mit einem Sensor (Q1); werkzeuglose Montage im Montageset durch Kugelschnappsystem; einfache elektrische Montage durch verpolungssichere Steckverbindung; geeignet für Deckenstärken von 2-25 mm; Oberfläche pulverbeschichtet; Einbau in unterschiedlichen Gehäusen möglich; hochwertiger Reflektor mit mikrofacetierter, aluminiumbedampfter Oberfläche; präzise Abstrahlcharakteristik mit unterschiedlichen symmetrischen Lichtverteilungen; oder mit asymmetrischer Lichtverteilung; energieeffiziente High-Power-LEDs mit sehr guter Farbwiedergabe; klirrfrei

Quickinfo

2700 K, 3000 K, 4000 K
 CRI ≥ 90, 3 SDCM
 UGR ≤ 19 / 65° ≤ 1500 cd/m²
 Q1 up to 85 lm/W
 Q4 up to 112 lm/W
 Q9 up to 111 lm/W
 L90 @ 50 000 h
 non DIM, DALI-2

Types

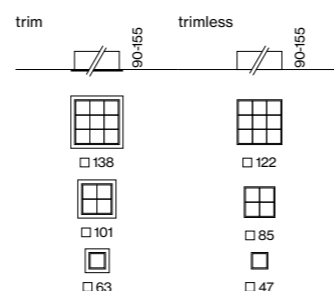

Colours



Light optics / sensors

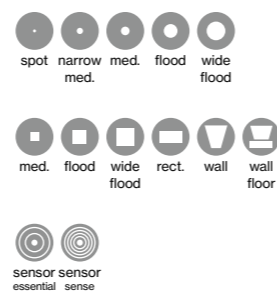

Data Monitoring

DiiA® standards
251, 252, 253

sensor version available

one luminaire multiple scenes

plug / socket connector

black & gold reflector

tunable white 2700-5000K

Order options

COLOUR TEMPERATURE	
2700 K	4
3000 K	5
4000 K	6

CONTROL	
non DIM	1
DALI-2	3

LIGHT OPTIC	
spot round (UGR ≤ 10)	K
narrow medium round (UGR ≤ 10)	N
medium round (UGR ≤ 10)	B
medium square (UGR ≤ 10)	E
flood round (UGR ≤ 16)	C
flood square (UGR ≤ 19)	F
wide flood round	D
wide flood square	G

MATERIAL COLOUR	
○ traffic white RAL 9016	W
● jet black RAL 9005	B

LIGHT OPTIC COLOUR	
chrome reflector	0
black reflector*	B

*not available for spot round, narrow medium round and wallwasher

Options on request

COLOUR TEMPERATURE	
tunable white 2700-5000K	
DALI-2 DT8	

LIGHT OPTIC COLOUR	
gold reflector	

MOUNTING SET	
acoustic soft ceilings	

Product configurator



Create your own UNICO PRO
unico.xal.com

Planning information

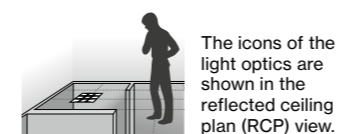

UNICO Q1 basic recessed

FLOOR		LUMINOUS FLUX		ORDER CODE
SYSTEM POWER	6 W	up to 490 lm		090-7 Q 1 :: A 0 2 1
choose one light optic ▲ from the options on the left depending on your room needs				
WALL		LUMINOUS FLUX		ORDER CODE
1x wallwasher	SYSTEM POWER	6 W	up to 415 lm	090-7 Q 1 :: A 0 2 1
CORRIDOR		LUMINOUS FLUX		ORDER CODE
1x rectangular	SYSTEM POWER	6 W	up to 414 lm	090-7 Q 1 :: R 0 2 1
WALL + FLOOR		LUMINOUS FLUX		ORDER CODE
1x wallwasher floor	SYSTEM POWER	6 W	up to 432 lm	090-7 Q 1 :: W 0 2 1

UNICO Q1 sensor recessed

ESSENTIAL SENSOR		ORDER CODE
TYPE	brightness & presence	090-7 Q 1 0 0 0 0
SENSE SENSOR		ORDER CODE
TYPE	brightness, presence, temperature, sound pressure, humidity, CO ₂	090-7 Q 1 0 0 1 0

Accessories

MOUNTING SET WITH TRIM			
for intermediate ceilings 2-25 mm			
TYPE	L-W-H (mm)	CUTOUT (mm)	ORDER CODE
Q1	63-63-30	50-50	090-7 Q 1 0 2 0 2
TRIMLESS MOUNTING SET			
for installation in plasterboard ceilings 12.5/15/20/25 mm			
TYPE	L-W-H (mm)	CUTOUT (mm)	ORDER CODE
Q1	50-50-47	50-50	090-7 Q 1 0 1 0 0

LUMINOUS FLUX value calculated for 3000 K, CRI ≥ 90, colour white, reflector chrome 2700 K -6%, 4000 K +7%

← back

Order options

COLOUR TEMPERATURE

2700K	4
3000K	5
4000K	6

CONTROL

non DIM	1
DALI-2	3

LIGHT OPTIC

spot round (UGR≤10)	K
narrow medium round (UGR≤10)	N
medium round (UGR≤10)	B
medium square (UGR≤10)	E
flood round (UGR≤16)	C
flood square (UGR≤19)	F
wide flood round	D
wide flood square	G

MATERIAL COLOUR

○ traffic white RAL 9016	W
● jet black RAL 9005	B

LIGHT OPTIC COLOUR

chrome reflector	O
black reflector*	B

*not available for spot round, narrow medium round and wallwasher

Options on request

COLOUR TEMPERATURE

tunable white 2700–5000K	
DALI-2 DT8	

LIGHT OPTIC COLOUR

gold reflector	
----------------	--

MOUNTING SET

acoustic soft ceilings	
------------------------	--

Product configurator



Create your own UNICO PRO

unico.xal.com

Planning information

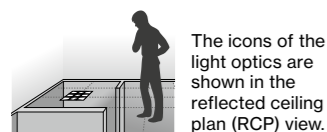

The icons of the light optics are shown in the reflected ceiling plan (RCP) view.

UNICO Q4 basic recessed

UGR ≤10	cd/m² ≤1500	CRI ≥90	DALI 1ADDR	220-240V	XPERT
---------	-------------	---------	------------	----------	-------

FLOOR

SYSTEM POWER	LUMINOUS FLUX	ORDER CODE
13.9W	up to 1450lm	090-7Q4::▲0■21

choose one light optic ▲ from the options on the left depending on your room needs

WALL

SYSTEM POWER	LUMINOUS FLUX	ORDER CODE
13.9W	1220lm	090-7Q4::▲A0021

CORRIDOR

SYSTEM POWER	LUMINOUS FLUX	ORDER CODE
13.9W	1220lm	090-7Q4::▲A0022

WALL + FLOOR

SYSTEM POWER	LUMINOUS FLUX	ORDER CODE
13.9W	1200lm	090-7Q4::▲90021

CORNER + FLOOR

SYSTEM POWER	LUMINOUS FLUX	ORDER CODE
13.9W	1200lm	090-7Q4::▲90022

WALL + FLOOR

SYSTEM POWER	LUMINOUS FLUX	ORDER CODE
13.9W	1280lm	090-7Q4::▲W0■21

Accessories

MOUNTING SET WITH TRIM
for intermediate ceilings 2–25 mm

TYPE	L-W-H (mm)	CUTOUT (mm)	ORDER CODE
Q4	101-101-30	90-90	090-7Q4020

TRIMLESS MOUNTING SET
for installation in plasterboard ceilings 12.5/15/20/25 mm

TYPE	L-W-H (mm)	CUTOUT (mm)	ORDER CODE
Q4	85-85-47	90-90	090-7Q40100

THROUGH WIRING CONNECTION BOX

TYPE	L-W-H (mm)	ORDER CODE
non DIM cable ø4–12mm	105-58-30	005-2531110
DALI cable ø4–12mm	105-58-30	005-2551110

LUMINOUS FLUX value calculated for 3000K, CRI≥90, colour white, reflector chrome
2700K -6%, 4000K +7%

Order options

COLOUR TEMPERATURE

2700K	4
3000K	5
4000K	6

CONTROL

non DIM	1
DALI-2	3

LIGHT OPTIC

spot round (UGR≤10)	K
narrow medium round (UGR≤10)	N
medium round (UGR≤10)	B
medium square (UGR≤10)	E
flood round (UGR≤16)	C
flood square (UGR≤19)	F
wide flood round	D
wide flood square	G

MATERIAL COLOUR

○ traffic white RAL 9016	W
● jet black RAL 9005	B

LIGHT OPTIC COLOUR

chrome reflector	O
black reflector*	B

*not available for spot round, narrow medium round and wallwasher

Options on request

COLOUR TEMPERATURE

tunable white 2700–5000K	
DALI-2 DT8	

LIGHT OPTIC COLOUR

gold reflector	
----------------	--

MOUNTING SET

acoustic soft ceilings	
------------------------	--

LUMINOUS FLUX value calculated for 3000K, CRI≥90, colour white, reflector chrome
2700K -6%, 4000K +7%

UNICO Q9 basic recessed

UGR ≤10	cd/m² ≤1500	CRI ≥90	DALI 1ADDR	220-240V	XPERT
---------	-------------	---------	------------	----------	-------

FLOOR

SYSTEM POWER	LUMINOUS FLUX	ORDER CODE
32W	up to 3310lm	090-7Q9::▲0■21

choose one light optic ▲ from the options on the left depending on your room needs

WALL

SYSTEM POWER	LUMINOUS FLUX	ORDER CODE
32W	2800lm	090-7Q9::▲A0021

WALL + FLOOR

SYSTEM POWER	LUMINOUS FLUX	ORDER CODE
32W	3080lm	090-7Q9::▲90021

WALL + CORRIDOR

SYSTEM POWER	LUMINOUS FLUX	ORDER CODE
32W	2790lm	090-7Q9::▲90022

WALL + FLOOR

SYSTEM POWER	LUMINOUS FLUX	ORDER CODE
32W	2920lm	090-7Q9::▲W0■21

Accessories

MOUNTING SET WITH TRIM
for intermediate ceilings 2–25 mm

TYPE	L-W-H (mm)	CUTOUT (mm)	ORDER CODE
Q9	138-138-30	130-130	090-7Q9020

TRIMLESS MOUNTING SET
for installation in plasterboard ceilings 12.5/15/20/25 mm

TYPE	L-W-H (mm)	CUTOUT (mm)	ORDER CODE
Q9	125-125-47	130-130	090-7Q90100

THROUGH WIRING CONNECTION BOX

TYPE	L-W-H (mm)	ORDER CODE
non DIM cable ø4–12mm	105-58-30	005-2531110
DALI cable ø4–12mm	105-58-30	005-2551110

LUMINOUS FLUX value calculated for 3000K, CRI≥90, colour white, reflector chrome
2700K -6%, 4000K +7%



Aertssen Group Beveren, BE –
by Mertens Architecten with
lighting design by Eef Debeuf



Fortuna Financial Group
Antwerp, BE – by Kris Rymenants
Architectenbureau



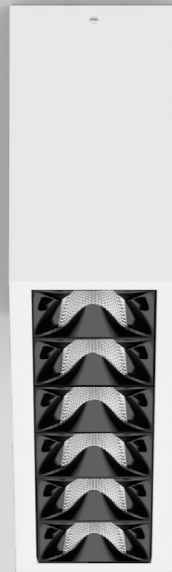

red dot winner 2020

UNICO linear

ceiling

EN Rectangular surface mounted multi-downlight made of aluminium; equipped with two (L2) / three (L3) / four (L4) / six (L6) individually selectable or pre-specified, customised light elements; luminaire housing can be attached to mounting plate without tools by interlock; converter integrated into luminaire housing; surface powder coated; high-quality reflector with micro-faceted, aluminum-vaporised surface; precise radiation characteristic with different symmetrical light distributions; or with asymmetric light distribution; energy-efficient high power LEDs with very good colour rendering; clank-free

DE Rechteckiger Anbau-Multi-Downlight aus Aluminium; bestückt mit zwei (L2) / drei (L3) / vier (L4) / sechs (L6) individuell wählbaren oder fix definierten, anwendungsspezifischen Optiken; Leuchtenkörper mittels Verriegelung werkzeuglos auf Montageplatte aufsetzbar; Konverter im Leuchtenkörper integriert; Oberfläche pulverbeschichtet; hochwertiger Reflektor mit mikrofacettierter, aluminiumverdampfter Oberfläche; präzise Abstrahlcharakteristik mit unterschiedlichen symmetrischen Lichtverteilungen; oder mit asymmetrischer Lichtverteilung; energieeffiziente High-Power-LEDs mit sehr guter Farbwiedergabe; klirrfrei

Quickinfo

2700 K, 3000 K, 4000 K
 CRI ≥ 90, 3 SDCM
 UGR ≤ 19 / 65° ≤ 3000 cd/m²
 L2 up to 95 lm/W
 L3 up to 97 lm/W
 L4 up to 103 lm/W
 L6 up to 103 lm/W
 L90 @ 50 000h
 non DIM, DALI-2

Types

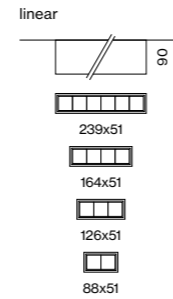

Colours



Light optics

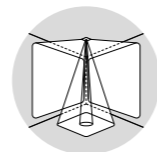
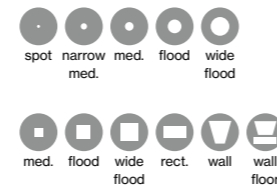

one luminaire
multiple scenes

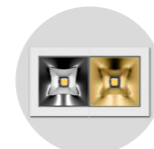

black & gold
reflector

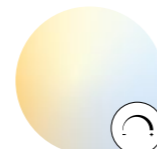

tunable white
2700–5000 K

Order options

COLOUR TEMPERATURE	
2700 K	4
3000 K	5
4000 K	6

CONTROL	
non DIM	1
DALI-2	3

LIGHT OPTIC	
spot round (UGR ≤ 10)	K
narrow medium round (UGR ≤ 10)	N
medium round (UGR ≤ 10)	B
medium square (UGR ≤ 10)	E
flood round (UGR ≤ 16)	C
flood square (UGR ≤ 19)	F
wide flood round	D
wide flood square	G

MATERIAL COLOUR	
○ traffic white RAL 9016	W
● white aluminium RAL 9006	G
● jet black RAL 9005	B
● gold dust RAL 260-M	9

LIGHT OPTIC COLOUR	
chrome reflector	0
black reflector*	B

*not available for spot round, narrow medium round and wallwasher

Options on request

COLOUR TEMPERATURE	
tunable white 2700–5000 K	
DALI-2 DT8	

LIGHT OPTIC COLOUR	
gold reflector	

Product configurator



Create your own UNICO PRO
unico.xal.com

Planning information

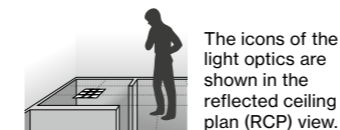

The icons of the light optics are shown in the reflected ceiling plan (RCP) view.

UNICO L2 basic ceiling

SYSTEM POWER	LUMINOUS FLUX	ORDER CODE
12.6 W	up to 1150 lm	090-1L2:::A■01

choose one light optic ▲ from the options on the left depending on your room needs

SYSTEM POWER	LUMINOUS FLUX	ORDER CODE
12.6 W	971 lm	090-1L2:::R■01

SYSTEM POWER	LUMINOUS FLUX	ORDER CODE
12.6 W	973 lm	090-1L2:::A■001

SYSTEM POWER	LUMINOUS FLUX	ORDER CODE
12.6 W	947 lm	090-1L2:::W■01

SYSTEM POWER	LUMINOUS FLUX	ORDER CODE
12.6 W	1020 lm	090-1L2:::W■02

UNICO L3 basic ceiling

SYSTEM POWER	LUMINOUS FLUX	ORDER CODE
18.9 W	up to 1720 lm	090-1L3:::A■01

choose one light optic ▲ from the options on the left depending on your room needs

SYSTEM POWER	LUMINOUS FLUX	ORDER CODE
18.9 W	1460 lm	090-1L3:::A■001

LUMINOUS FLUX value calculated for
 3000 K, CRI ≥ 90, colour white, reflector chrome
 2700 K -6%, 4000 K +7%

← back

Order options

COLOUR TEMPERATURE

2700K	4
3000K	5
4000K	6

CONTROL

non DIM	1
DALI-2	3

LIGHT OPTIC

spot round (UGR≤10)	K
narrow medium round (UGR≤10)	N
medium round (UGR≤10)	B
medium square (UGR≤10)	E
flood round (UGR≤16)	C
flood square (UGR≤19)	F
wide flood round	D
wide flood square	G

MATERIAL COLOUR

○ traffic white RAL 9016	W
● white aluminium RAL 9006	G
● jet black RAL 9005	B
● gold dust RAL 260-M	9

LIGHT OPTIC COLOUR

chrome reflector	O
black reflector*	B

*not available for spot round, narrow medium round and wallwasher

Options on request

COLOUR TEMPERATURE

tunable white 2700-5000K
DALI-2 DT8

LIGHT OPTIC COLOUR

gold reflector

Product configurator



Create your own UNICO PRO
unico.xal.com

Planning information

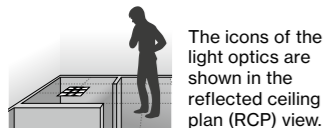

The icons of the light optics are shown in the reflected ceiling plan (RCP) view.

UNICO L4 basic ceiling

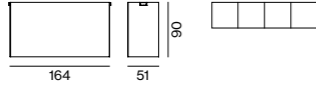

FLOOR	SYSTEM POWER	LUMINOUS FLUX	ORDER CODE
20.4W	up to 1920lm	090-1L4::A01	

choose one light optic ▲ from the options on the left depending on your room needs



WALL	SYSTEM POWER	LUMINOUS FLUX	ORDER CODE
4x wallwasher	20.4W	1620lm	090-1L4::A001



FLOOR/WALL + FLOOR	SYSTEM POWER	LUMINOUS FLUX	ORDER CODE
4x wallwasher floor	20.4W	1690lm	090-1L4::W01



WALL + FLOOR	SYSTEM POWER	LUMINOUS FLUX	ORDER CODE
4x wallwasher floor	20.4W	1690lm	090-1L4::W02

UNICO L6 basic ceiling

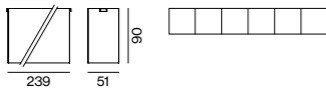
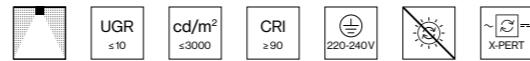

FLOOR	SYSTEM POWER	LUMINOUS FLUX	ORDER CODE
28.6W	up to 2790lm	090-1L6::A01	

choose one light optic ▲ from the options on the left depending on your room needs



CORRIDOR	SYSTEM POWER	LUMINOUS FLUX	ORDER CODE
6x rectangular	28.6W	2350lm	090-1L6::R01



WALL	SYSTEM POWER	LUMINOUS FLUX	ORDER CODE
6x wallwasher	28.6W	2360lm	090-1L6::A001



WALL + FLOOR	SYSTEM POWER	LUMINOUS FLUX	ORDER CODE
6x wallwasher floor	28.6W	2460lm	090-1L6::W01

LUMINOUS FLUX value calculated for 3000K, colour white, reflector chrome 2700K -6%, 4000K +7%



Babylon
 Den Haag, NL – by Studio Linse

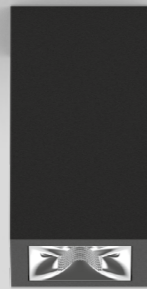
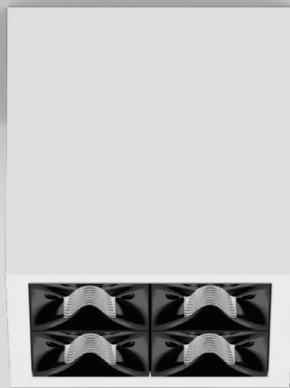
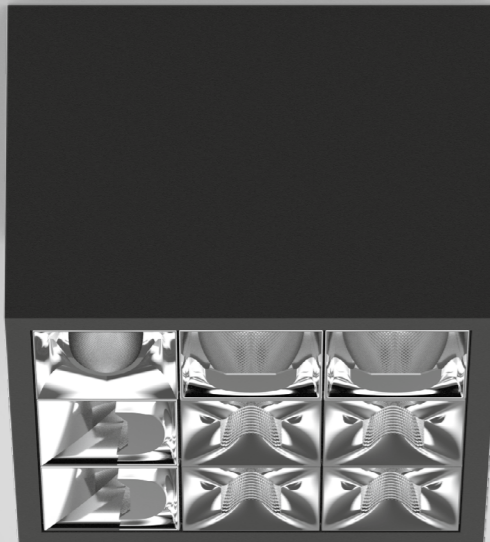

reddot winner 2020

UNICO square

ceiling

EN Square surface mounted multi-downlight made of aluminium; equipped with one (Q1) / four (Q4) / nine (Q9) individually selectable or pre-specified, customised light element(s); luminaire housing can be attached to mounting plate without tools by interlock; converter integrated into luminaire housing; surface powder coated; high-quality reflector with micro-faceted, aluminum-vaporised surface; precise radiation characteristic with different symmetrical light distributions; or with asymmetric light distribution; energy-efficient high power LEDs with very good colour rendering; clank-free

DE Quadratischer Anbau-Multi-Downlight aus Aluminium; bestückt mit einer (Q1) / vier (Q4) / neun (Q9) individuell wählbaren oder fix definierten, anwendungsspezifischen Optik(en); Leuchtenkörper mittels Verriegelung werkzeuglos auf Montageplatte aufsetzbar; Konverter im Leuchtenkörper integriert; Oberfläche pulverbeschichtet; hochwertiger Reflektor mit mikrofacettierter, aluminiumbedampfter Oberfläche; präzise Abstrahlcharakteristik mit unterschiedlichen symmetrischen Lichtverteilungen; oder mit asymmetrischer Lichtverteilung; energieeffiziente High-Power-LEDs mit sehr guter Farbwiedergabe; klirrfrei

Quickinfo

2700 K, 3000 K, 4000 K
CRI ≥ 90, 3 SDCM
UGR ≤ 19 / 65° ≤ 3000 cd/m²
Q1 up to 95 lm/W
Q4 up to 103 lm/W
Q9 up to 105 lm/W
L90 @ 50 000 h
non DIM, DALI-2

Types

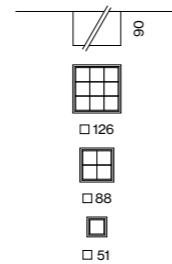

Colours



Light optics

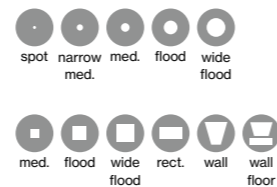

Order options

COLOUR TEMPERATURE	
2700 K	4
3000 K	5
4000 K	6

CONTROL	
non DIM	1
DALI-2	3

LIGHT OPTIC	
spot round (UGR ≤ 10)	K
narrow medium round (UGR ≤ 10)	N
medium round (UGR ≤ 10)	B
medium square (UGR ≤ 10)	E
flood round (UGR ≤ 16)	C
flood square (UGR ≤ 19)	F
wide flood round	D
wide flood square	G

MATERIAL COLOUR	
○ traffic white RAL 9016	W
● white aluminium RAL 9006	G
● jet black RAL 9005	B
● gold dust RAL 260-M	9

LIGHT OPTIC COLOUR	
chrome reflector	0
black reflector*	B

*not available for spot round, narrow medium round and wallwasher

Options on request

COLOUR TEMPERATURE	
tunable white 2700–5000 K	
DALI-2 DT8	

LIGHT OPTIC COLOUR	
gold reflector	

Product configurator



Create your own UNICO PRO
unico.xal.com

Planning information

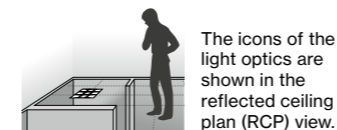

The icons of the light optics are shown in the reflected ceiling plan (RCP) view.



one luminaire
multiple scenes

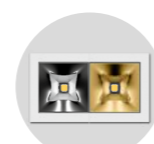

black & gold
reflector

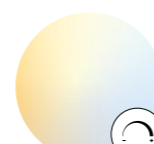

tunable white
2700–5000 K

UNICO Q1 basic ceiling

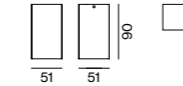

FLOOR	SYSTEM POWER	LUMINOUS FLUX	ORDER CODE
	6.5 W	up to 575 lm	090-1Q1::1▲■01

choose one light optic ▲ from the options on the left depending on your room needs

UNICO Q4 basic ceiling

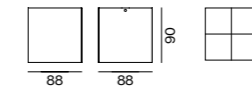
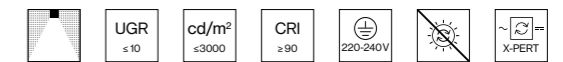

FLOOR	SYSTEM POWER	LUMINOUS FLUX	ORDER CODE
	20.4 W	up to 1920 lm	090-1Q4::4▲■01

choose one light optic ▲ from the options on the left depending on your room needs



WALL	SYSTEM POWER	LUMINOUS FLUX	ORDER CODE
4x wallwasher	20.4 W	1620 lm	090-1Q4::4▲■001



CORNER + FLOOR	SYSTEM POWER	LUMINOUS FLUX	ORDER CODE
2x wallwasher floor + 2x medium square	20.4 W	1630 lm	090-1Q4::49■01

UNICO Q9 basic ceiling

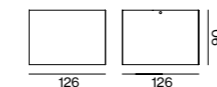
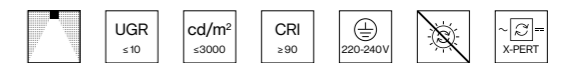

FLOOR	SYSTEM POWER	LUMINOUS FLUX	ORDER CODE
	36 W	up to 3550 lm	090-1Q9::9▲■01

choose one light optic ▲ from the options on the left depending on your room needs



WALL	SYSTEM POWER	LUMINOUS FLUX	ORDER CODE
9x wallwasher	36 W	3000 lm	090-1Q9::9▲■001



WALL + CORRIDOR	SYSTEM POWER	LUMINOUS FLUX	ORDER CODE
6x wallwasher floor + 3x rectangular	36 W	3090 lm	090-1Q9::99■01

LUMINOUS FLUX value calculated for
3000 K, CRI ≥ 90, colour white, reflector chrome
2700 K -6%, 4000 K +7%

Granitlab Coworking
St. Martin im Mühlkreis, AT –
by GHT-Plan GmbH with lighting design
by GHT-Plan GmbH, AREA C.I. Design GmbH



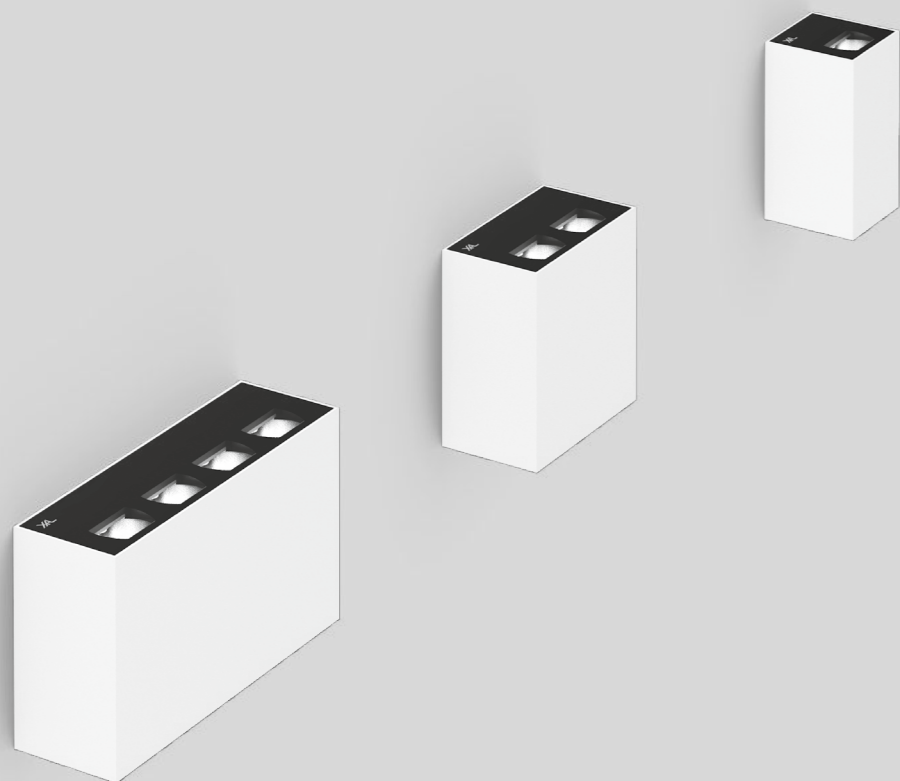

UNICO

wall surface

EN Rectangular wall surface mounted multi-uplight made of aluminium; equipped with one light inset (1 lamp) / two (2 lamps) / four (4 lamps) light insets; luminaire housing can be attached to mounting plate without tools by interlock; converter integrated into luminaire housing; surface powder coated; high-quality reflector with micro-faceted, aluminum-vaporised surface; homogeneous wall or ceiling illumination through uniform light distribution; energy-efficient high power LEDs with very good colour rendering; luminaire for through wiring

DE Rechteckiger Wandanbau-Multi-Uplight aus Aluminium; bestückt mit einem Lichteinsatz (1 lamp) / zwei (2 lamps) / vier (4 lamps) Lichteinsätzen; Leuchtenkörper mittels Verriegelung werkzeuglos auf Montageplatte aufsetzbar; Konverter im Leuchtenkörper integriert; Oberfläche pulverbeschichtet; hochwertiger Reflektor mit mikrofaccettierter, aluminiumbedampfter Oberfläche; homogene Wand- bzw. Deckenaufhellung durch gleichmäßige Lichtverteilung; energieeffiziente High-Power-LEDs mit sehr guter Farbwiedergabe; Leuchte für Weiterverdrahtung

Quickinfo

2700 K, 3000 K, 4000 K
 CRI ≥ 90, 3 SDCM
 up to 49 lm/W
 L90 @ 50 000 h
 non DIM, DALI-2

Types

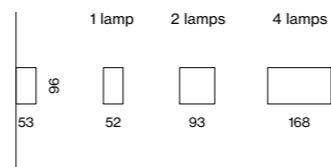

Colours



Light distribution



ceiling washer



homogeneous ceiling illumination

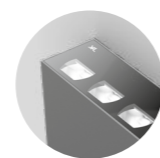

safety glass for dust protection

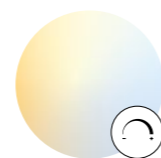

tunable white 2700–5000 K

Order options

COLOUR TEMPERATURE	
2700 K	4
3000 K	5
4000 K	6

CONTROL	
non DIM	1
DALI-2	3

MATERIAL COLOUR	
○ traffic white RAL 9016	W
● white aluminium RAL 9006	G
● jet black RAL 9005	B

Options on request

COLOUR TEMPERATURE
 tunable white 2700–5000 K
 only available for 2 lamps and 4 lamps
 DALI-2 DT8

Light distribution

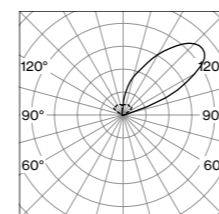

microprismatic direct/indirect power

LUMINOUS FLUX value calculated for 3000 K, CRI ≥ 90, colour white, reflector chrome 2700 K -6%, 4000 K +7%

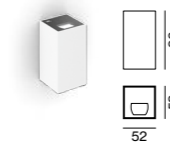

UNICO wall surface

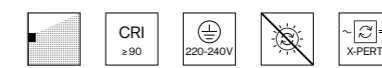

1 LAMP	LUMINOUS FLUX	ORDER CODE
SYSTEM POWER 5.9 W	240 lm	090-0L1::1T001

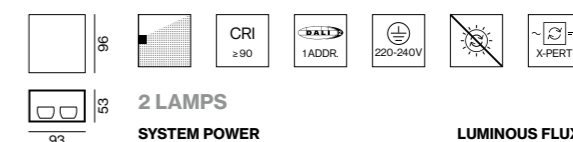

2 LAMPS	LUMINOUS FLUX	ORDER CODE
SYSTEM POWER 17.4 W	740 lm	090-0L2::2T001

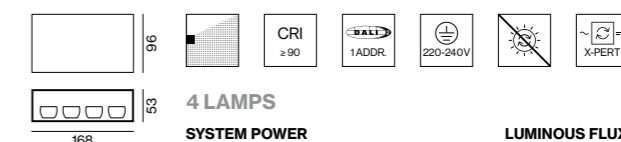

4 LAMPS	LUMINOUS FLUX	ORDER CODE
SYSTEM POWER 30.0 W	1380 lm	090-0L4::4T001

Office
Visualisation



← back

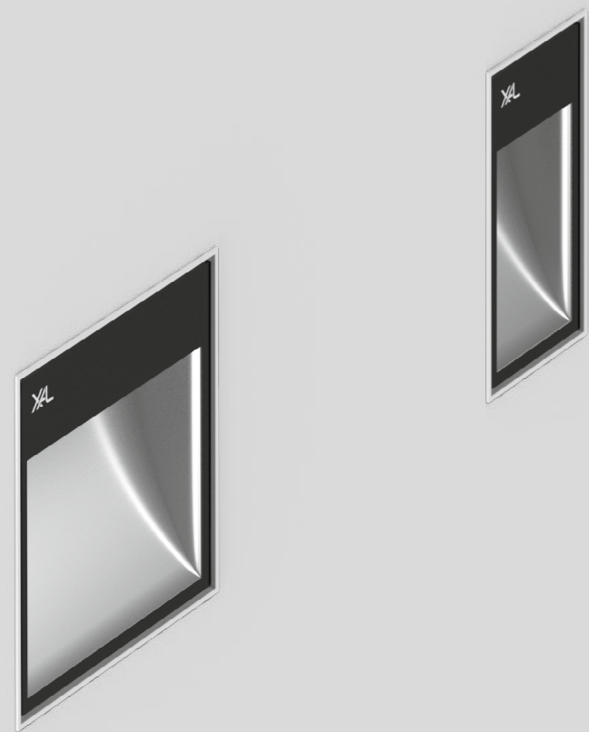

UNICO

wall recessed

EN Recessed wall luminaire in aluminium; installation without tools in mounting set (trimless or with trim) with ball catch system; installation possible in different housings; surface powder coated; incl. external converter; high-quality reflector with micro-faceted, aluminum-vaporised surface; different asymmetrical light distributions; installation optionally for floor or ceiling illumination; energy-efficient high power LEDs with very good colour rendering

DE Wandeinbauleuchte aus Aluminium; werkzeuglose Montage im Montageset (randlos oder mit umlaufendem Rand) durch Kugelschnappsystem; Einbau in unterschiedlichen Gehäusen möglich; Oberfläche pulverbeschichtet; inkl. externem Konverter; hochwertiger Reflektor mit mikrofacettierter, aluminiumbedampfter Oberfläche; unterschiedliche asymmetrische Lichtverteilungen; Montage wahlweise zur Boden- oder Deckenaufhellung; energieeffiziente High-Power-LEDs mit sehr guter Farbwiedergabe

Quickinfo

2700 K, 3000 K, 4000 K
 CRI ≥ 90, 3 SDCM
 up to 53 lm/W
 L90 @ 50 000 h
 non DIM, DALI-2

Types

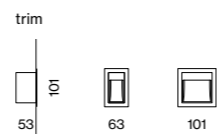

Colours



Light distribution

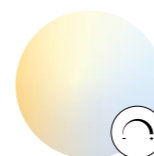

Order options

COLOUR TEMPERATURE	
2700 K	4
3000 K	5
4000 K	6

CONTROL	
non DIM	1
DALI-2	3

LIGHT OPTIC	
wide floor	

MATERIAL COLOUR	
○ traffic white RAL 9016	W
● jet black RAL 9005	B

Options on request

COLOUR TEMPERATURE	
tunable white 2700–5000 K	

only available for 2 lamps | DALI-2 DT8

Light distribution

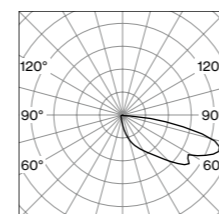

microprismatic
 direct/indirect power

LUMINOUS FLUX value calculated for 3000 K, CRI ≥ 90, colour white, reflector chrome
 2700 K -6%, 4000 K +7%

UNICO wall recessed

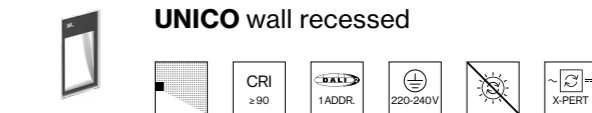

1 LAMP		LUMINOUS FLUX	ORDER CODE
SYSTEM POWER	7.3 W	340 lm	090-6L1::UB001

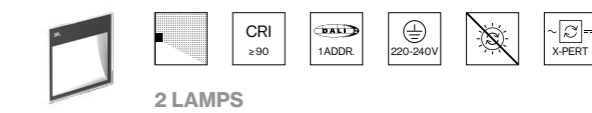

2 LAMPS		LUMINOUS FLUX	ORDER CODE
SYSTEM POWER	12.5 W	610 lm	090-6L2::UB001

Accessories

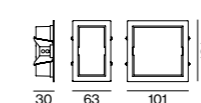

MOUNTING SET WITH TRIM			
for intermediate ceilings 2–25 mm			
TYPE	L-W-H (mm)	CUTOUT (mm)	ORDER CODE
1 lamp	101-63-20	90-50	090-7L2020
2 lamps	101-101-30	90-50	090-7Q4020

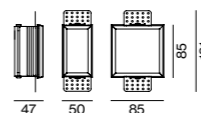

TRIMLESS MOUNTING SET			
for installation in plasterboard ceilings 12.5/15/20/25 mm			
TYPE	L-W-H (mm)	CUTOUT (mm)	ORDER CODE
1 lamp	88-50-47	90-50	090-7L20100
2 lamps	85-85-47	90-50	090-7Q40100

PRIMED CONCRETE MOUNTING SET		
TYPE	L-W-H (mm)	ORDER CODE
primed concrete ceilings	240-400-130	052-1914320

order mounting set separately

EXPOSED CONCRETE MOUNTING SET		
TYPE		ORDER CODE
1 lamp exposed concrete		090-6L10500
2 lamps exposed concrete		090-6L20600

order mounting set separately

Planning information

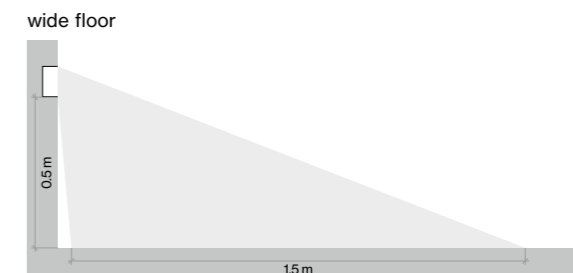

Office
Visualisation



Hidden talent

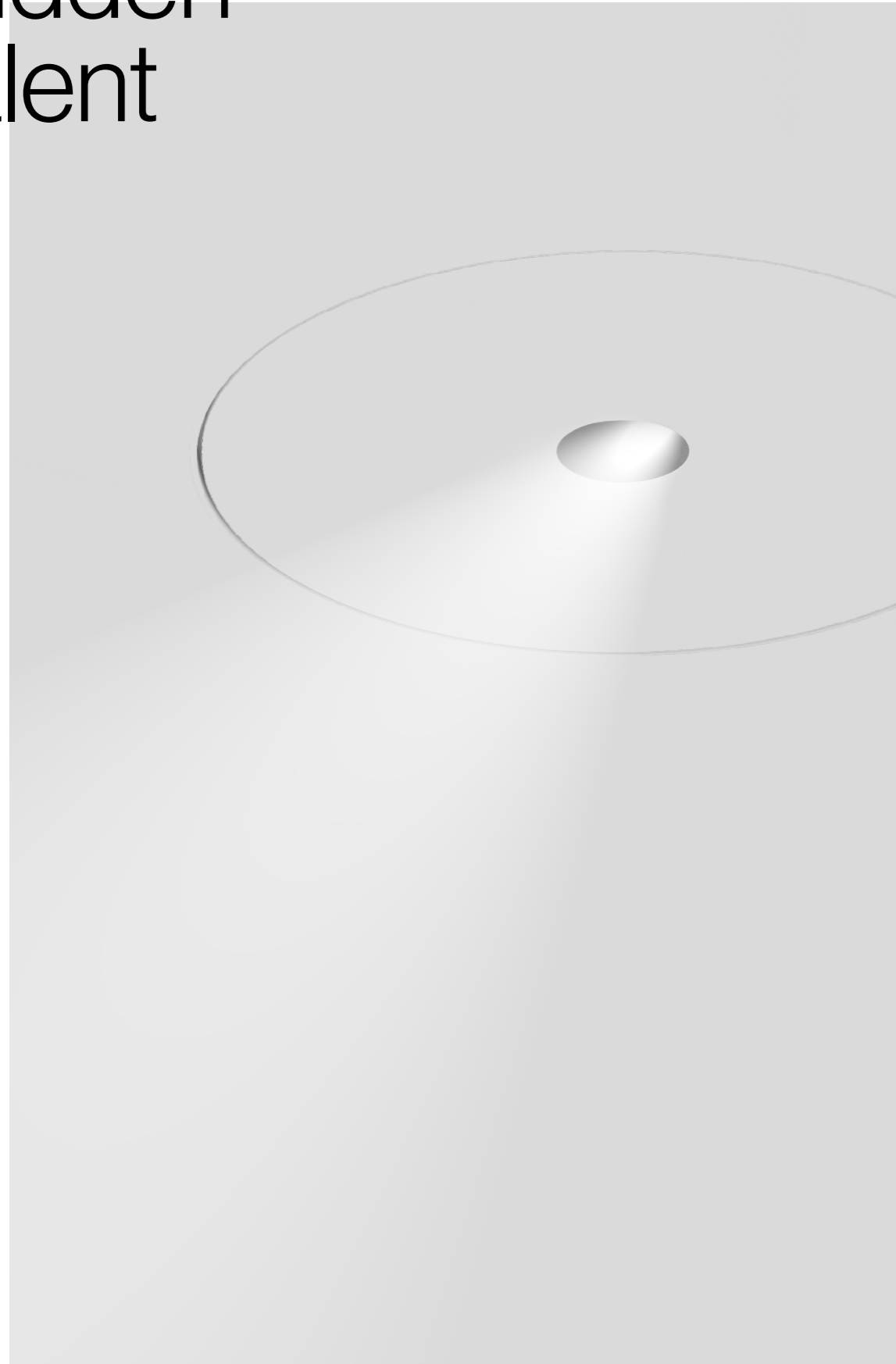

SPIO

EN Round, recessed SPIO spotlights bring special lighting to your rooms. The luminaire provides an impressive lighting effect, trimless or with a trim. The housing can be painted over, allowing the spotlight to blend seamlessly into the ceiling. The small light aperture of 10 mm makes the SPIO itself appear almost hidden – but the equally effective and calm overall impression is anything but invisible. The round, recessed spotlight is available with beam angles of 35° or 44° and can be rotated 360° in the housing and pivoted 30° in all directions. These different lighting options mean that versatile designs for interiors are possible. SPIO is available in the light colours 2700 K, 3000 K, and 4000 K.

DE Mit den runden SPIO Einbaustrahlern bringen Sie eine besondere Beleuchtung in Ihre Räume. Die Leuchte sorgt für eine beeindruckende Lichtwirkung, randlos oder mit umlaufendem Rand. Das Gehäuse kann einfach überstrichen werden, wodurch sich der Strahler nahtlos ins Deckenbild einfügt. Die geringe Lichtaustrittsöffnung von 10 mm lässt die SPIO selbst beinahe verborgen erscheinen – der gleichermaßen effektvolle und ruhige Gesamteindruck ist aber alles andere als unsichtbar. Der runde Einbau-Spot ist mit den Ausstrahlwinkel von 35° oder 44° verfügbar und ist im Gehäuse um 360° drehbar und in alle Richtungen 30° schwenkbar. Dadurch ergibt sich eine vielseitige Raumgestaltung auf Basis der unterschiedlichen Beleuchtungsmöglichkeiten. SPIO ist in den Lichtfarben 2700 K, 3000 K und 4000 K erhältlich.

Type



60

Mountings

trimless
recessedwith trim
recessed

Light distributions

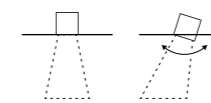

downlight

spotlight

High-efficiency lens

EN Large light output – almost unnoticed. SPIO has a special LFO lens, which is mounted at an exact distance from the light-emission surface, thus ensuring that no light beam appears on the inner surface of the housing. This reduces the light-emission surface, and SPIO illuminates the room almost unnoticed.

DE Großer Lichtoutput – nahezu unbemerkt. SPIO verfügt über eine spezielle LFO Linse, welche in einem exakten Abstand zur Lichtaustrittsfläche montiert wird. Dieser ist so bemessen, dass kein Lichtstrahl an der Innenfläche des Gehäuses auftritt. Dadurch wird die Lichtaustrittsfläche reduziert und SPIO beleuchtet den Raum nahezu unbemerkt.



Light distribution

EN Despite its small emission surface, the recessed spotlight achieves a beam angle of either 35° or 44°. SPIO thus provides glare-free light and skilfully stages objects.

DE Trotz seiner geringen Austrittsfläche erreicht der Einbaustrahler einen Ausstrahlwinkel von wahlweise 35° oder 44°. Dadurch gibt SPIO blendfreies Licht und setzt Objekte gekonnt in Szene.

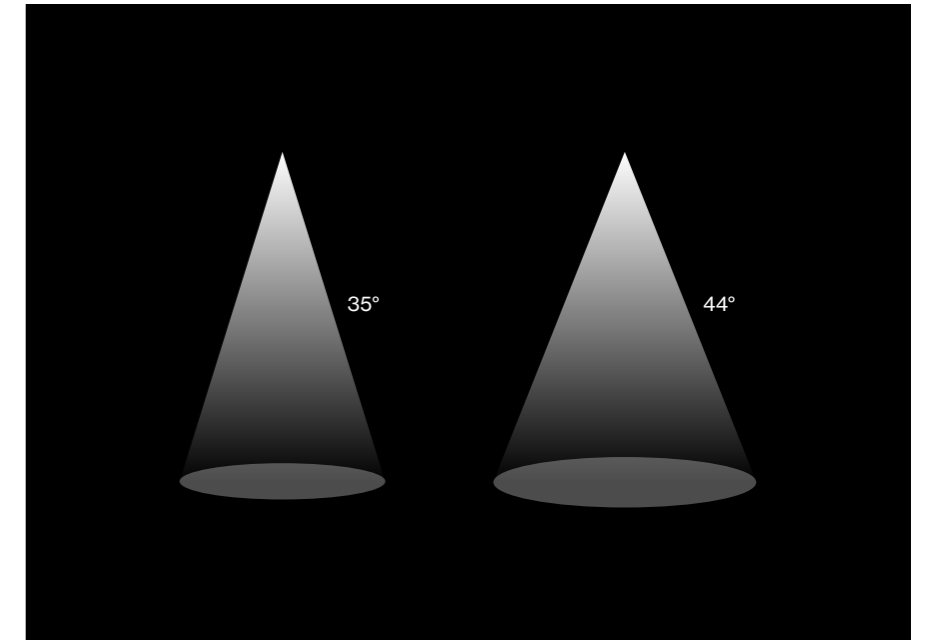

Homogeneous appearance

EN SPIO is the right choice for a uniform ceiling appearance. Thanks to its extremely small light aperture of 10 mm, the recessed spotlight appears almost invisible. The effective lighting is rounded off by its minimalist design language.

DE Für ein einheitliches Deckenbild ist SPIO die richtige Wahl. Dank seiner ausgesprochen geringen Lichtaustrittsöffnung von 10 mm ist der Einbaustrahler beinahe unsichtbar. Die effektive Lichtwirkung wird abgerundet durch seine minimalistische Formensprache.

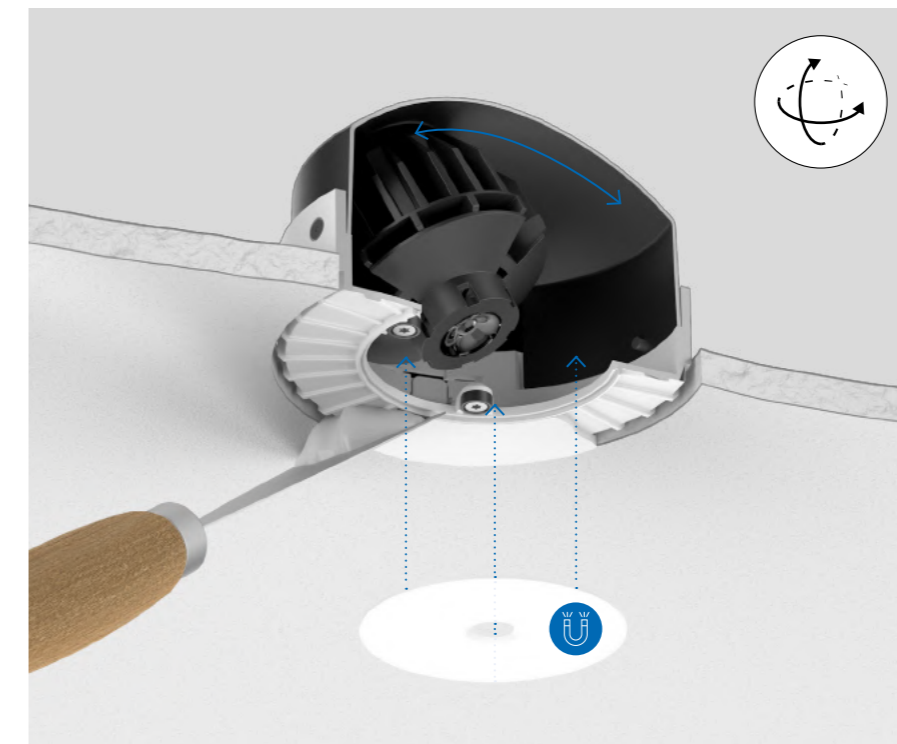

Precise light adjustment

EN The adjustable version of SPIO, patent pending, can be moved in all directions thanks to a magnetic plate. The spotlight can thus both be rotated 360° and pivoted up to 30° in all directions. As a result, it offers the greatest flexibility in directing and guiding light exactly where it is desired.

DE Die zum Patent angemeldete adjustable Version von SPIO kann aufgrund eines magnetischen Strahlerkopfes in alle Richtungen bewegt werden. Der Strahler kann zudem nicht nur um 360° gedreht, sondern auch um bis zu 30° in alle Richtungen geschwenkt werden. Dadurch bietet er größte Flexibilität in der Ausrichtung und Lenkung des Lichtes genau dorthin, wo es gewünscht ist.

Smooth and invisible

EN The trimless SPIO version can easily be maintained and adjusted thanks to its magnetic cover. The spotlight is completely fitted into a plasterboard ceiling. The recessed housing and ceiling can subsequently be painted over. The spots thus appear "invisible", creating a homogeneous, effective overall impression.

DE Die randlose Variante von SPIO ist durch die magnetische Abdeckplatte einfach zu warten und zu adjustieren. Der Strahler wird vollkommen in einer Gipskartondecke verbaut. Anschließend kann das Einbaugehäuse gemeinsam mit der Zimmerdecke überstrichen werden. Die Spots wirken dadurch „unsichtbar“ – es entsteht ein homogener wirkungsvoller Gesamteindruck.

← back

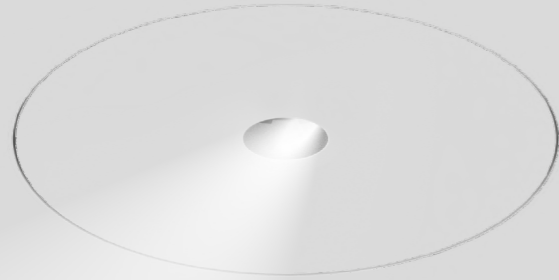

SPIO 60

recessed

EN Round recessed spotlight in die-cast aluminium; installation without tools in mounting set with ball catch system or with magnetic attachment; for trimless installation in plasterboard ceilings; paintable cover; shadow joint between cover and mounting set optionally fillable; choice of adjustable or fixed symmetric radiation characteristic; high quality lens system; uncluttered ceiling look through recessed lighting level; reduced light-emitting surface (only ø10 mm); no multiple shadows; efficient LEDs with very good colour rendering

DE Runder Einbaustrahler aus Aluminiumdruckguss; werkzeuglose Montage im Montageset durch Kugelschnappsystem oder mittels Magnetbefestigung; für randlosen Einbau in Gipskartondecken; überstreichbare Abdeckplatte; Schattenfuge zwischen Abdeckplatte und Montageset optional verspachtelbar; wahlweise einstellbar oder starr symmetrische Abstrahlcharakteristik; hochwertige Linsenoptik; ruhiges Deckenbild durch zurückversetzte Leuchtenebene; reduzierte Lichtaustrittsfläche (nur ø10 mm); keine Mehrfachschatten; effiziente LEDs mit sehr guter Farbwiedergabe

Quickinfo

2700 K, 3000 K
CRI ≥ 90, 2 SDCM
up to 60 lm/W
L80 @ 50 000 h
non DIM, DALI-2

Types

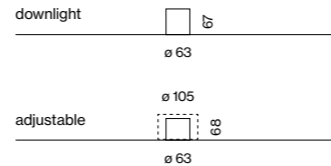

Colour



Light distributions



Order options

COLOUR TEMPERATURE	
2700 K	4
3000 K	5

MATERIAL COLOUR

○ traffic white RAL9016
paintable cover

BEAM ANGLE

flood 35°	F
wide flood 44°	W

Options on request

COLOUR TEMPERATURE
4000 K

CONCRETE HOUSING

primed concrete ceiling
exposed concrete ceiling

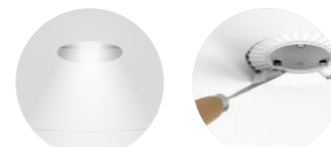

10 mm light output area

trimless installation

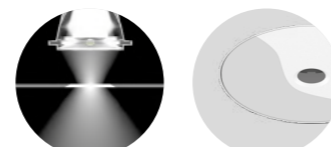

LFO lens technology

paintable cover

INSET POWER is the current consumption excluding any ballast
LUMINOUS FLUX value calculated for 3000 K, CRI ≥ 90, colour white, lens flood 2700 K -5%



SPIO 60 downlight



DOWNLIGHT	LUMINOUS FLUX	ORDER CODE
INSET POWER 12.2 W 12 Vf 1050 mA	693 lm	0 4 8 - 1 5 1 0 :: 1 7 ▲

Mounting accessories

TRIMLESS MOUNTING SET for plasterboard ceilings 12.5/15/25 mm	ORDER CODE
COLOUR ○ traffic white RAL9016	0 4 8 - 2 6 9 6 1 1 7

MOUNTING SET WITH TRIM for intermediate ceilings 2–25 mm

COLOUR	ORDER CODE
○ traffic white RAL9016	0 4 8 - 1 5 9 7 2 0 7
● jet black RAL 9005	0 4 8 - 1 5 9 7 2 0 8

SPIO 60 adjustable



ADJUSTABLE	LUMINOUS FLUX	ORDER CODE
INSET POWER 9.7 W 12 Vf 850 mA	582 lm	0 4 8 - 1 5 2 0 :: 1 7 ▲

Mounting accessories

TRIMLESS MOUNTING SET for plasterboard ceilings 12.5/15/25 mm	ORDER CODE
COLOUR ○ traffic white RAL9016	0 4 8 - 1 5 9 8 1 0 7

MOUNTING SET WITH TRIM for intermediate ceilings 2–25 mm

COLOUR	ORDER CODE
○ traffic white RAL9016	0 4 8 - 1 5 9 7 1 0 7
● jet black RAL 9005	0 4 8 - 1 5 9 7 1 0 8

Electrical accessories

POWER SUPPLY 220-240 V AC, 50-60 Hz, PC II			
TYPE	EFFICIENCY	L-W-H (mm)	ORDER CODE
850 mA non DIM	η 85 %	147-44-22	0 0 2 - 9 0 7 8 5
850 mA DALI-2	η 85 %	147-44-22	0 0 2 - 9 0 7 8 6
1050 mA non DIM	η 85 %	147-44-22	0 0 2 - 9 0 7 8 7
1050 mA DALI-2	η 85 %	147-44-22	0 0 2 - 9 0 7 8 8

DIN RAIL COMPONENTS

TYPE	W-H-D (mm)	ORDER CODE
POWER SUPPLY 220-240 V AC 96 W 48 V DC constant voltage	90-90-60	0 0 5 - 6 5 2 0 2 1 0
LED DRIVER DALI-2 DT6 1-2 addr. 200-1050 mA settable const. current 2 × 42 W 48 V DC U _{OUT} 10-40 V	36-88-59	0 0 5 - 6 1 2 1 0 3 0

for more details and components see page 981

Private Residence
Visualisation



Private Residence
Visualisation



Spotlights behind the scene



CAVO

EN CAVO embodies a new type of lighting system. The round, square, rectangular, or flexible installation system can be integrated flush in suspended ceilings. The spotlights can be positioned and connected almost anywhere using a patented magnet system while remaining discreetly in the background. The spots can be rotated and swivelled individually. The glowing variant offers decorative indirect lighting of the recessed housing, which backlights the spots and effectively de-locates the light points.

DE CAVO verkörpert eine neue Art von Lichtsystem. Das runde, quadratische oder rechteckige flexibel gestaltbare Einbaugehäuse wird flächenbündig in abgehängte Decken integriert. Dort können die Strahler anhand eines patentierten Magnetsystems nahezu beliebig positioniert sowie angeschlossen werden und halten sich dezent im Hintergrund. Die Spots sind individuell dreh- und schwenkbar. Zusätzlich bietet die Glowing Variante eine dekorative Indirektbeleuchtung des Einbaugehäuses, die die Spots hinterleuchtet und die Lichtpunkte effektiv entortet.

Types

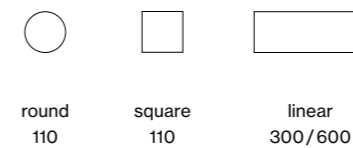

Mountings

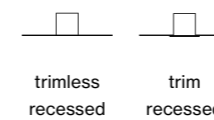

Light distributions

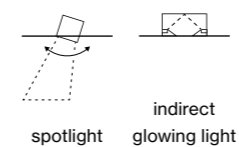

Works invisibly

EN CAVO spotlights are mounted without tools and magnetically fixed, discreetly concealing the light source in the housing. The recessed light point plane also provides ample glare control.

DE CAVO Strahler werden werkzeuglos montiert und magnetisch fixiert, wodurch sich die Lichtquelle dezent im Gehäuse versteckt. Die zurückversetzte Lichtpunktebene schafft zusätzlich eine gute Entblendung.

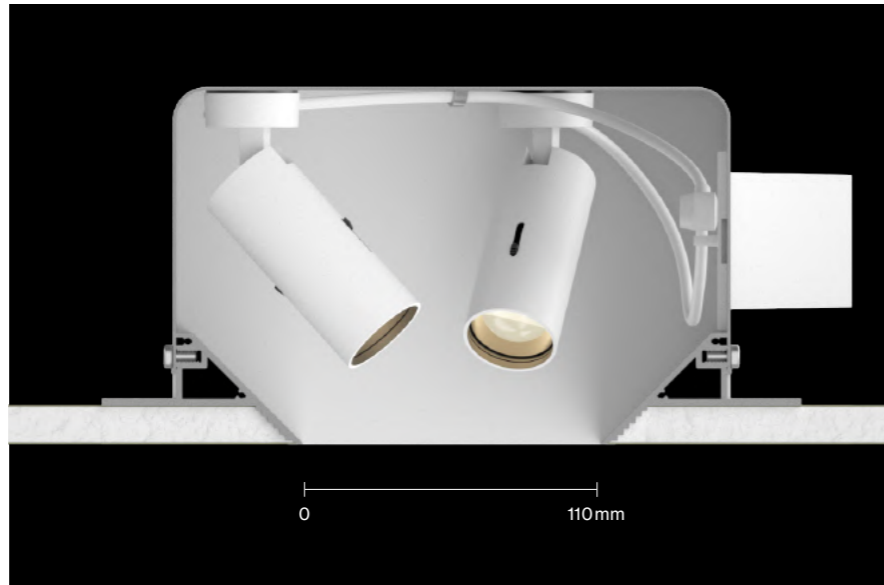

Glowing effect

EN CAVO Glowing is a variant with powerful indirect lighting. Light insets, which are placed inside the box and the housing channel, illuminate from within. This creates subtle, decorative indirect light in the channel, complementing the directional light.

DE Bei CAVO Glowing handelt es sich um eine Variante mit effektvoller Indirektbeleuchtung. Eigene Lichteinsätze in der Box bzw. im Gehäusekanal leuchten diese von innen aus. Dadurch entsteht dezentes, dekoratives Indirektlicht im Kanal, welches das gerichtete Licht ergänzt.



Magnetic attachment

EN CAVO spotlights are easy to rotate and swivel and can be repositioned and rearranged according to requirements, providing maximum mobility and light exactly where it is needed. The magnet system repositions each spotlight within the housing with just one touch.

DE Höchste Beweglichkeit und Licht genau dort, wo es benötigt wird: CAVO Strahler sind einfach dreh- und schwenkbar und können je nach Anforderung neu positioniert und angeordnet werden. Dank eines Magnetsystems wird jeder Strahler innerhalb des Gehäuses mit nur einem Handgriff neu positioniert.

Variety

EN The individual housing is directly attached to the bare ceiling. As a single luminaire, CAVO has four different recessed housings (round, square, or rectangular in two lengths), which can be arranged with up to six spotlights.

DE Das Einzelgehäuse wird direkt an der Rohdecke befestigt. Als Einzelleuchte verfügt CAVO über vier unterschiedliche Einbauegehäuse (rund, quadratisch oder rechteckig in zwei Längen), die mit bis zu sechs Strahlern arrangiert werden können.

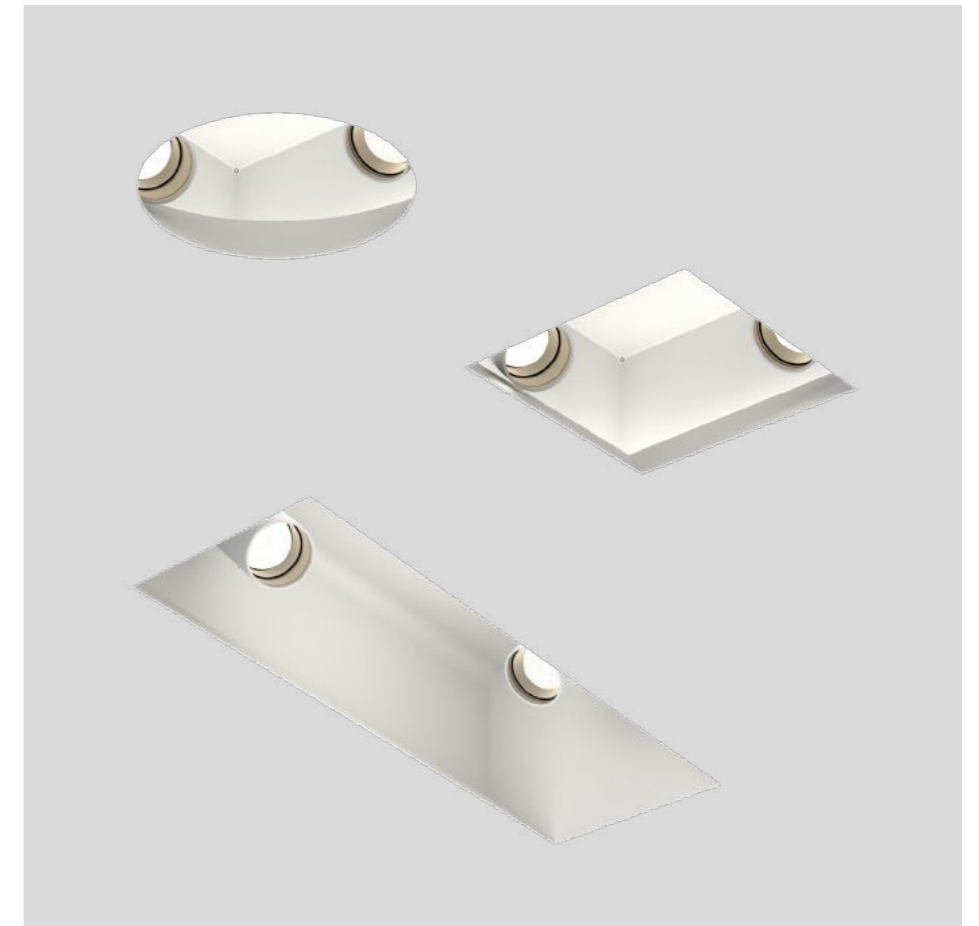

← back

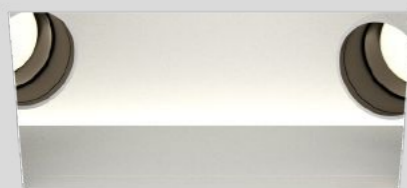

CAVO round/square

recessed

EN Recessed housing made of pressed steel sheet for flush installation in plasterboard ceilings, underside of aluminium-reinforced plaster; alternatively with round or square cut-out; no break-out of edges; 3 cylindrical spotlight heads can be installed without tools by means of magnetic holders; simple electrical connection of the spotlights due to non-reversible plug and play connection; housing and spotlights powder coated; optionally: indirect light component in housing; COB (Chip on Board) technology for maximum efficiency; no multiple shadows; efficient LEDs with very good colour rendering; good glare reduction due to recessed light point plane; high quality lens system; precise radiation characteristic; optical attachments as accessories; hot plug protection

DE Einbaugehäuse aus Stahlblech für randlosen Einbau in Gipskartondecken, Unterseite aus aluminiumverstärktem Gips; wahlweise mit rundem oder quadratischem Ausschnitt; kein Ausbrechen der Kanten; 3 zylindrische Strahlköpfe mittels Magnethalter werkzeuglos einsetzbar; einfacher elektrischer Anschluss der Strahler durch verpolungssichere Plug & Play Verbindung; Gehäuse und Strahler pulverbeschichtet; optional: Indirektlichtanteil im Gehäuse; COB (Chip on Board) Technologie für höchste Effizienz; keine Mehrfachschatten; effiziente LEDs mit sehr guter Farbwiedergabe; gute Entblendung durch zurückversetzte Lichtpunktebene; hochwertige Linsenoptik; präzise Abstrahlcharakteristik; optische Aufsätze als Zubehör; Hot Plug-Schutz

Quickinfo

2700 K, 3000 K
CRI ≥ 90, 2 SDCM
DALI-2

L80 @ 50 000 h
mounting housing with glowing

L90 @ 50 000 h
JUST 45 up to 69lm/W

L95 @ 50 000 h
JUST 32 focus up to 3x54 lm/W

Types

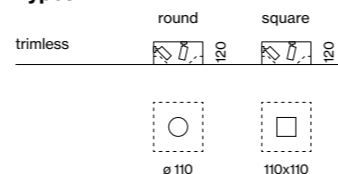

Housing colours



Inset colours



Light distributions



Order options

COLOUR TEMPERATURE	
2700 K	4
3000 K	5

CONTROL
DALI-2

INSET COLOUR	
○ traffic white RAL 9016	7
● jet black RAL 9005	8
● gold dust RAL 260-M	9

HOUSING COLOUR	
○ traffic white RAL 9016	7
● jet black RAL 9005	8

BEAM ANGLE	
medium 23°	M
flood 44°	F

Options on request

OPTICAL ACCESSORIES
elliptical sculpture foil
snoot
colour filter (red, blue, green, etc.)
only for JUST 32 focus



JUST 32 focus 17-43°

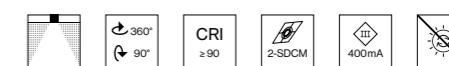

SPOTLIGHT	INSET POWER	LUMINOUS FLUX	ORDER CODE
	4.6 W	250 lm	0 4 9 - 8 2 1 1 :: 3 ▽
not for single use			

JUST 45

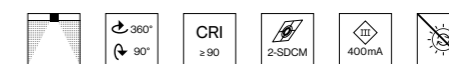

SPOTLIGHT	INSET POWER	LUMINOUS FLUX	ORDER CODE
	8.8 W	640 lm	0 4 9 - 8 3 0 2 :: 3 ▽

Mounting accessories

MOUNTING HOUSING 1 DALI-2 address
for trimless installation in plasterboard ceilings 8-25 mm

TYPE	L-W-H (mm)	ORDER CODE
round 3 spots (4.5 kg)	260-260-120	0 4 9 - 8 8 0 3 0 3 ▽
square 3 spots (4.5 kg)	260-260-120	0 4 9 - 8 8 1 3 0 3 ▽

incl. power supply 220-240 V AC, 50-60 Hz, PC I, ENEC approved

MOUNTING HOUSING WITH GLOWING (3000 K) 2 DALI-2 addresses
for trimless installation in plasterboard ceilings 8-25 mm

TYPE	L-W-H (mm)	ORDER CODE
round 3 spots (4.5 kg)	260-260-120	0 4 9 - 8 8 2 3 5 3 7
square 3 spots (4.5 kg)	260-260-120	0 4 9 - 8 8 3 3 5 3 7

incl. power supply 220-240 V AC, 50-60 Hz, PC I, ENEC approved

Optical accessories

HONEYCOMB LOUVER

TYPE	Ø-H (mm)	ORDER CODE
JUST 32 focus	30-4	0 0 7 - 1 9 6 5 1 6 8
JUST 45	42-3	0 0 7 - 1 9 6 5 1 8 8

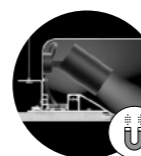
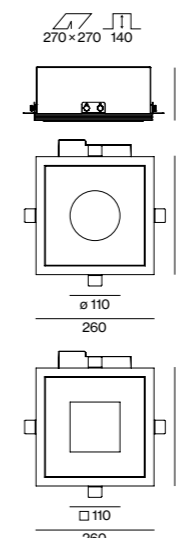

magnetic holders for tool-free mounting



optical accessories

INSET POWER is the current consumption excluding any ballast
LUMINOUS FLUX value calculated for 3000 K, CRI ≥ 90, colour white, lens medium 2700 K -5%

Freigeist Brauquartier
Graz, AT – by FIPE ARCHITECTURE
with lighting design by Eugen Schöberl



← back



Quickinfo

2700 K, 3000 K
CRI ≥ 90, 2 SDCM
DALI-2

L90 @ 50 000 h
JUST 45 up to 6×69 lm/W

L95 @ 50 000 h
JUST 32 focus up to 6×54 lm/W

Types

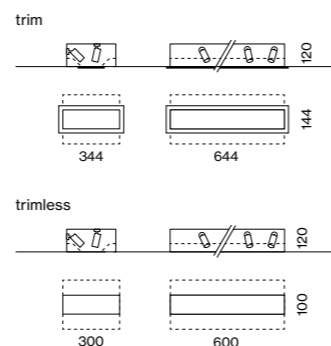

Housing colours



Inset colours



Light distributions



Order options

COLOUR TEMPERATURE	
2700 K	4
3000 K	5

CONTROL
DALI-2

INSET COLOUR	
○ traffic white RAL 9016	7
● jet black RAL 9005	8
● gold dust RAL 260-M	9

HOUSING COLOUR	
○ traffic white RAL 9016	7
● jet black RAL 9005	8

BEAM ANGLE	
medium 23°	M
flood 44°	F

Options on request

OPTICAL ACCESSORIES
elliptical sculpture foil
snoot
colour filter (red, blue, green, etc.)
only for JUST 32 focus

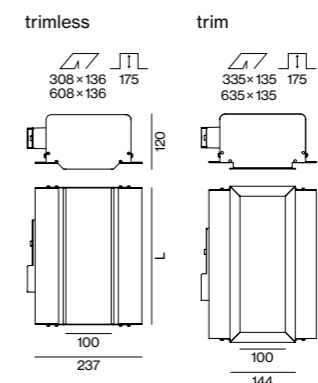

JUST 32 focus 17-43°

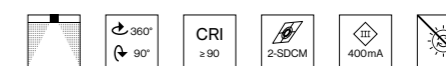

SPOTLIGHT	INSET POWER	LUMINOUS FLUX	ORDER CODE
	4.6 W	250 lm	0 4 9 - 8 2 1 1 :: 3 ▽
not for single use			

JUST 45

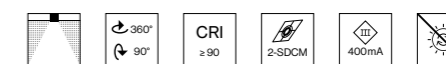

SPOTLIGHT	INSET POWER	LUMINOUS FLUX	ORDER CODE
	8.8 W	640 lm	0 4 9 - 8 3 0 2 :: 3 ▽

Mounting accessories

TRIMLESS MOUNTING HOUSING			
for trimless installation in plasterboard ceilings 12.5 mm			
TYPE	L-W-H (mm)	ORDER CODE	
for 3 spots (▲ 2.4 kg), 1 DALI	308-252-120	0 4 9 - 8 8 4 3 0 3 ▽	
for 6 spots (▲ 3.6 kg), 2 DALI	608-269-120	0 4 9 - 8 8 4 6 0 3 ▽	
incl. power supply 220-240 V AC, 50-60 Hz, Ⓢ PC I, ENEC approved			

MOUNTING HOUSING WITH TRIM			
for intermediate ceilings 12.5 mm			
TYPE	L-W-H (mm)	ORDER CODE	
for 3 spots (▲ 2.7 kg), 1 DALI	344-254-120	0 4 9 - 8 8 5 3 0 3 ▽	
for 6 spots (▲ 4.7 kg), 2 DALI	644-271-120	0 4 9 - 8 8 5 6 0 3 ▽	
incl. power supply 220-240 V AC, 50-60 Hz, Ⓢ PC I, ENEC approved			

Optical accessories

HONEYCOMB LOUVER		
TYPE	Ø-H (mm)	ORDER CODE
JUST 32 focus	30-4	0 0 7 - 1 9 6 5 1 6 8
JUST 45	42-3	0 0 7 - 1 9 6 5 1 8 8

CAVO linear

recessed

EN Installation housing in pressed steel sheet with rectangular cut-out; for trimless installation in plasterboard ceilings; special edge design with perforations for better adhesion of filler; or with trim; 3 or 6 cylindrical spotlight heads can be installed without tools by means of magnetic holders; simple electrical connection of the spotlights due to non-reversible plug and play connection; housing and spotlights powder coated; COB (Chip on Board) technology for maximum efficiency; no multiple shadows; efficient LEDs with very good colour rendering; good glare reduction due to recessed light point plane; high quality lens system; precise radiation characteristic; optical attachments as accessories; hot plug protection

DE Einbaugehäuse aus Stahlblech mit rechteckigem Ausschnitt; für randlosen Einbau in Gipskartondecken; spezielle Randausbildung mit Löchern für bessere Haftung der Spachtelmasse; oder mit umlaufendem Rand; 3 bzw. 6 zylindrische Strahlerköpfe mittels Magnethalter werkzeuglos einsetzbar; einfacher elektrischer Anschluss der Strahler durch verpolungssichere Plug & Play Verbindung; Gehäuse und Strahler pulverbeschichtet; COB (Chip on Board) Technologie für höchste Effizienz; keine Mehrfachschatten; effiziente LEDs mit sehr guter Farbwiedergabe; gute Entblendung durch zurückversetzte Lichtpunktenebene; hochwertige Linsenoptik; präzise Abstrahlcharakteristik; optische Aufsätze als Zubehör; Hot Plug-Schutz



magnetic holders for tool-free mounting



optical accessories

INSET POWER is the current consumption excluding any ballast
LUMINOUS FLUX value calculated for 3000 K, CRI ≥ 90, colour white, lens medium 2700 K -5%

Boutique Frame Moscow, RU –
by Architectural Group Method with
lighting design by KA2 Light Architecture



Combine with your design

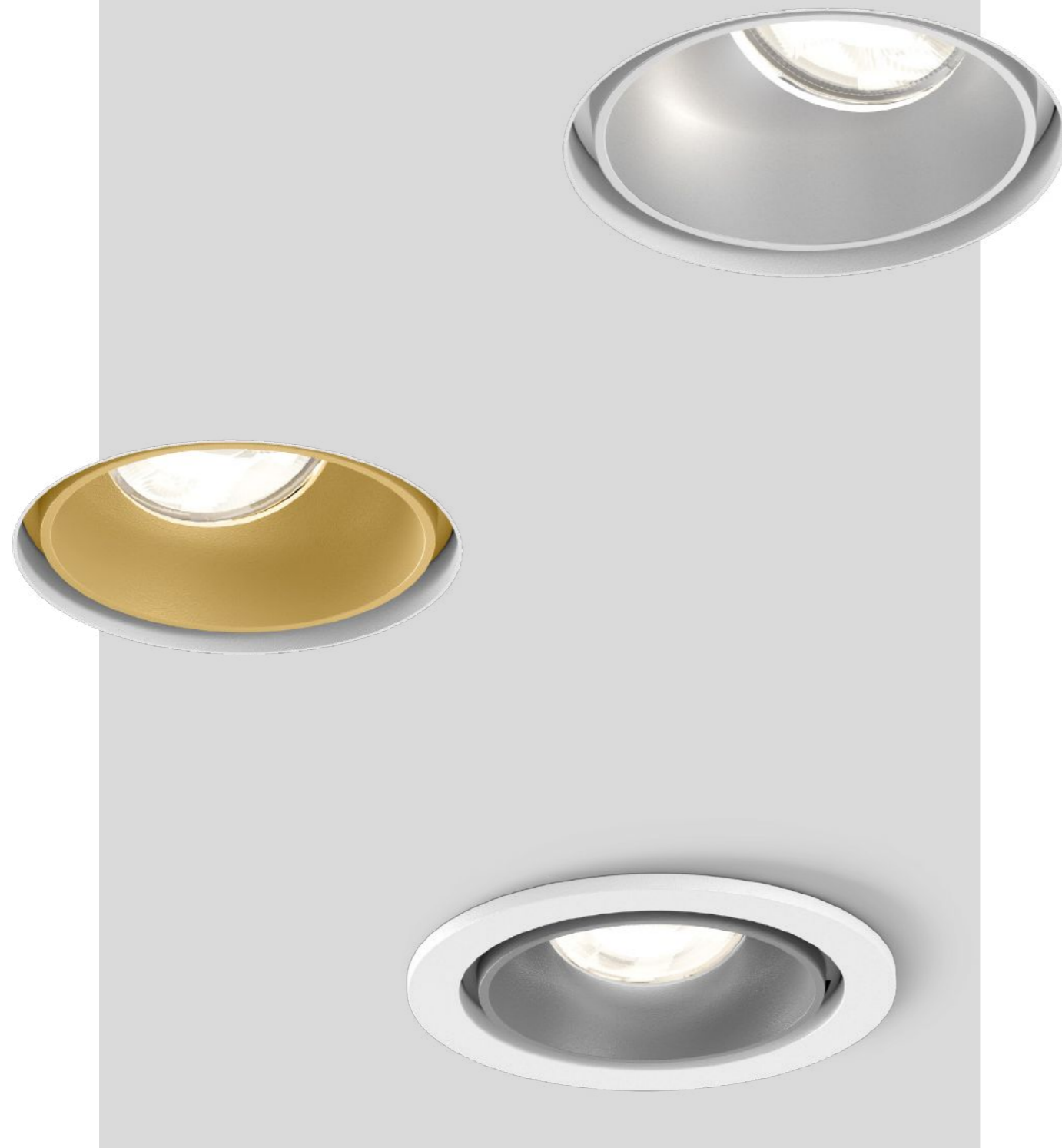

SASSO

EN SASSO is a glamorous lighting solution for extravagant interior concepts regardless of how it is used. The versatile spotlight series is available as a recessed, semi-recessed, ceiling- or wall-mounted, or suspended version. Choose between round or square versions, as well as single or double-lamp spotlights in some versions. To ensure the spot fits harmoniously into the overall design, it is available in many colours. The housing colours white, black, and silver can be optimally combined with a selection of differently coloured insets. SASSO is available with different light distribution characteristics – either as spotlight, downlight, wallwasher, or wallwasher floor. In addition, sensors or emergency insets are optionally available. The series is characterised by an excellent colour rendering up to $CRI \geq 95$ (2-SDCM) in all light colours: 2700K, 3000K, 4000K, or Colour Warm Dimming.

DE Wie sie auch zum Einsatz kommt, SASSO ist eine glamouröse Lichtlösung für extravagante Interior-Konzepte. Die vielfältige Strahlerserie ist in zahlreichen Varianten verfügbar: als Einbau-, Halbeinbau, Decken- oder Wandbauvariante sowie in abgependelter Ausführung. Außerdem haben Sie die Wahl zwischen runden oder quadratischen Varianten, sowie in manchen Ausführungen auch als ein- oder zweiflämmige Strahler. Um den Strahler harmonisch in die Gesamtgestaltung einzufügen, ist er in vielen Farben erhältlich – wobei die Housing Farben Weiß, Schwarz und Silber optimal mit einer Auswahl an verschiedenfarbigen Insets kombinierbar sind. SASSO ist in verschiedene Abstrahlcharakteristiken verfügbar – wahlweise als Spotlight, Downlight, Wallwasher oder Wallwasher Floor. Zusätzlich sind wahlweise Sensoren oder Emergency Insets erhältlich. In allen Lichtfarben – 2700K, 3000K, 4000K oder Colour Warm Dimming – zeichnet sich die Serie zudem durch eine sehr gute Farbwiedergabe von bis zu $CRI \geq 95$ (2-SDCM) aus.

Types

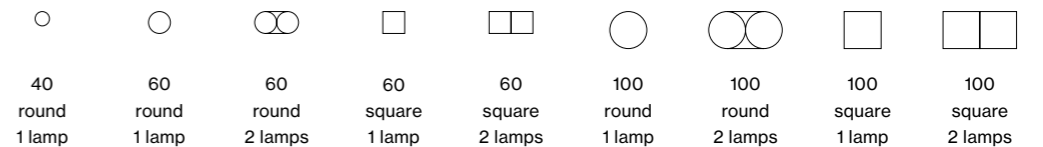

Mountings

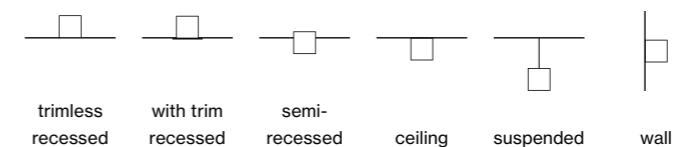

Light distributions

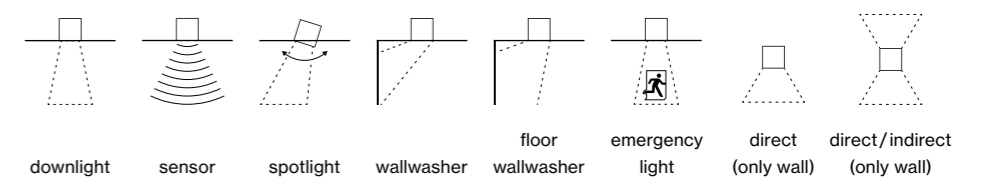

SASSO recessed

Light engines

SASSO 40
round
adjustable/
downlight

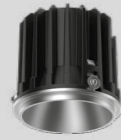

SASSO 40
round
wallwasher /
wallwasher floor



SASSO 60
round
adjustable/
downlight



SASSO 60
round
wallwasher /
wallwasher floor

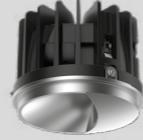

SASSO 60
square
downlight



SASSO 60
square
wallwasher /
wallwasher floor

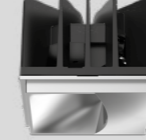

SASSO 100
round
adjustable/
downlight

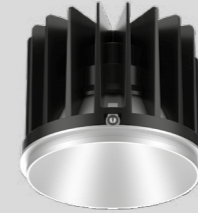

SASSO 100
round
wallwasher /
wallwasher floor



SASSO 100
square
adjustable/
downlight

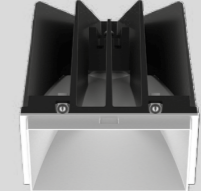

SASSO 100
square
wallwasher /
wallwasher floor

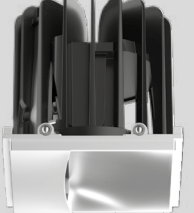

INSET POWER
LUMINOUS EFFICACY
LUMINOUS FLUX
COLOUR TEMPERATURE
BEAM ANGLE
IP RATING

7.4W
up to 84lm/W
up to 624lm
2700, 3000, 4000K
14°, 27°, 45°
‡ IP40 / † IP20 (adj.)
‡ IP44 / † IP20 (dl.)

6.8W
up to 97lm/W
up to 659lm
2700, 3000, 4000K
asymmetric
IP20

10.7W
up to 107lm/W
up to 1150lm
2700,3000,4000K,CWD
15°, 21°, 42°
‡ IP40 / † IP20 (adj.)
‡ IP44 / † IP20 (dl.)

8.2W
up to 89lm/W
up to 726lm
2700, 3000, 4000K
asymmetric
IP20

10.7W
up to 110lm/W
up to 1180lm
2700,3000,4000K,CWD
15°, 21°, 42°
‡ IP44 / † IP20

8.2W
up to 89lm/W
up to 726lm
2700, 3000, 4000K
asymmetric
IP20

17.2W, 25W
up to 116lm/W
up to 2630lm
2700, 3000, 4000K
19°, 34°, 45°, 65°
‡ IP40 / † IP20 (adj.)
‡ IP44 / † IP20 (dl.)

25W, 23.4W
up to 120lm/W
up to 2810lm
2700, 3000, 4000K
asymmetric
IP20

17.2W, 25W
up to 116lm/W
up to 2640lm
2700, 3000, 4000K
19°, 34°, 45°, 65°
‡ IP40 / † IP20 (adj.)
‡ IP44 / † IP20 (dl.)

25W, 23.4W
up to 120lm/W
up to 2810lm
2700, 3000, 4000K
asymmetric
IP20

MATERIAL COLOUR

matt silver, white,
black, gold

matt silver, white,
black, gold

matt silver, white,
black, gold

matt silver, white,
black, gold

matt silver, white,
black, gold

matt silver, white,
black, gold

matt silver, white,
black, gold

matt silver, white,
black, gold

matt silver, white,
black, gold

matt silver, white,
black, gold

Mounting accessories



round trimless
for plasterboard ceilings 12.5/15/25 mm

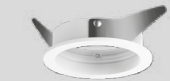
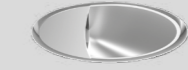

round with trim | 1 lamp
for intermediate ceilings 2-25 mm



round with trim | 2 lamps
for intermediate ceilings 2-25 mm



square trimless
for plasterboard ceilings 12.5/15/25 mm



square with trim | 1 lamp
for intermediate ceilings 2-25 mm

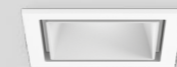

square with trim | 2 lamps
for intermediate ceilings 2-25 mm



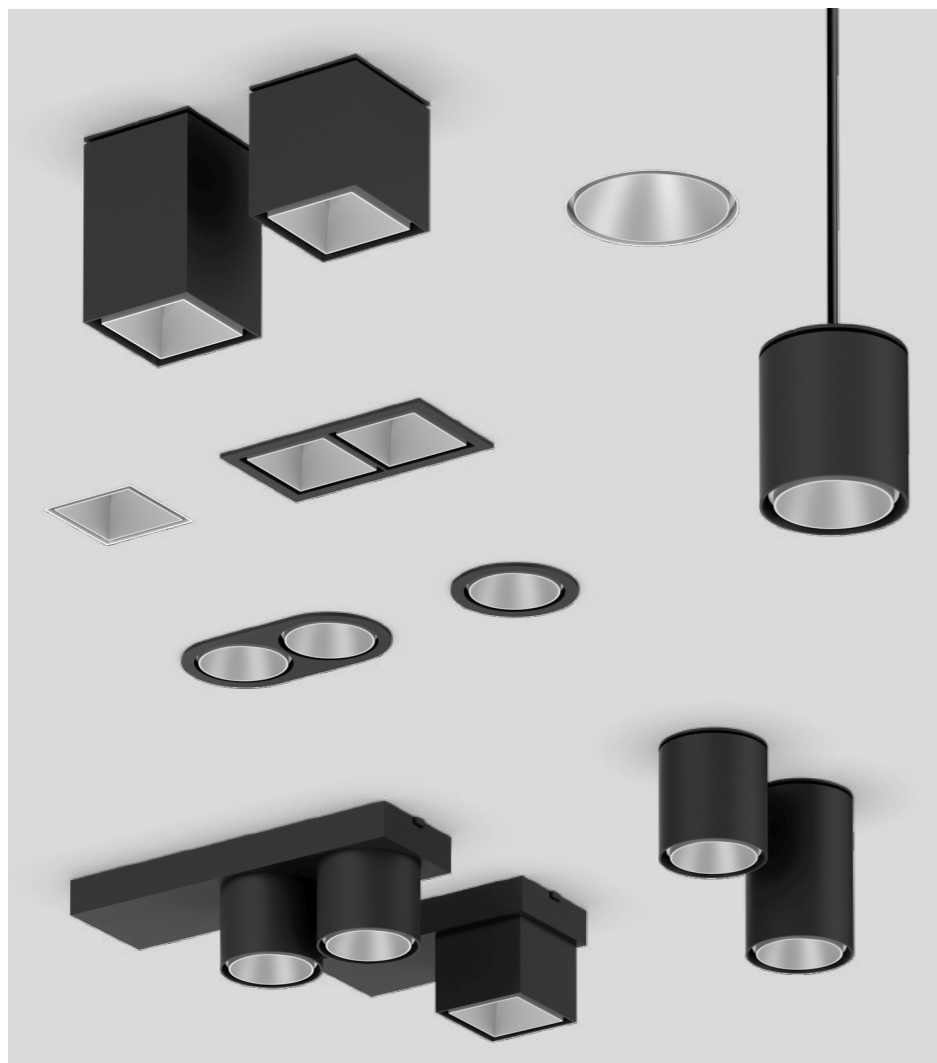

Variety

EN SASSO can be integrated into any lighting design concept. The spotlights are available as recessed, semi-recessed, wall and ceiling mounted variants, as single or dual-lamp spotlights in an elegant base, or as suspended versions. Depending on the interior design, choose between round or square luminaires and the recessed set with or without trim.

DE SASSO integriert sich in jedes lichtplanerische Konzept. Die Strahler sind als Einbau-, Halbeinbau- und Wand- sowie Deckenanbauvariante als ein- oder zweiflammiger Strahler in einem eleganten Gehäuse, oder als abgependelte Variante verfügbar. Je nach Raumgestaltung haben Sie die Wahl zwischen runden oder quadratischen Leuchten sowie dem Einbauset mit oder ohne Rand.

Colour variety

EN SASSO is available in many different colour variations to complement custom designs and colour concepts. The select housing colours (white, black, and silver) combine beautifully with silver, white, black, or gold insets, delivering a harmonious, high-quality overall design.

DE Um sich individuellen Entwürfen und Farbvorstellungen anzupassen, ist SASSO in vielen verschiedenen Farbvarianten erhältlich. Die speziellen Gehäusefarben (Weiß, Schwarz und Silber) lassen sich sehr gut mit Insets in Silber, Weiß, Schwarz oder Gold kombinieren: mit dem Ergebnis eines harmonischen, hochwertigen Gesamtbildes.



Housing colours

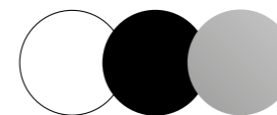

SASSO 60/100 recessed

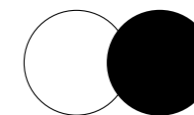

SASSO 40 recessed
SASSO 60/100 semi-recessed/
ceiling / suspended / wall

Inset colours



Precise light adjustment

EN A patented swivel mechanism offers the highest possible flexibility. The spotlight can be rotated through 360° and swivelled up to 30° around the horizontal axis. This enables light to be directed precisely where it is needed.

DE Ein patentierter Schwenkmechanismus schafft größtmögliche Flexibilität. Der Strahler kann nicht nur um 360° gedreht, sondern auch bis zu 30° um die horizontale Achse geschwenkt werden. Das ermöglicht die präzise Lenkung des Lichts genau dorthin, wo es gewünscht ist.



Low recess depth

EN SASSO 40 complements XAL's SASSO product family with a small, flexible spotlight that is particularly impressive due to its low height. This makes it an ideal lighting solution for ceiling constructions with an unusually low installation depth.

DE SASSO 40 erweitert die SASSO-Produktfamilie von XAL um einen kleinen, flexiblen Strahler, der vor allem durch seine geringe Höhe überzeugt. Dadurch ist er eine optimale Lichtlösung für Deckenkonstruktionen mit besonders niedriger Einbautiefe.

Light distributions

EN SASSO has four optics and thus fulfils all the fundamental functions of your lighting concept. Vertical lighting is provided by downlights with different beam angles; wallwasher and wall-floor optics provide extensive wall and floor illumination; the adjustable spotlight sets accents. If the functional area changes, the optics in the luminaire housing can be simply replaced without tools.

DE SASSO verfügt über vier Optiken und erfüllt so alle Grundfunktionen Ihres Beleuchtungskonzeptes. Vertikale Beleuchtung wird durch Downlights mit unterschiedlichen Abstrahlwinkeln erzielt, Wallwasher- und Wall-Floor-Optiken sorgen für großflächige Wand- sowie Bodenaufhellung, der Richtstrahler setzt Akzente. Wechselt der Funktionsbereich, kann die Optik im Leuchtgehäuse einfach und werkzeuglos getauscht werden.

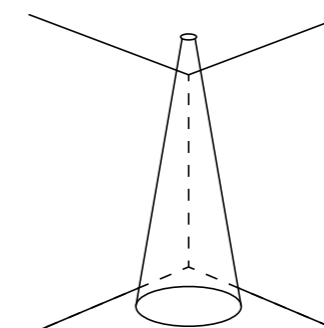

SASSO 60 downlight

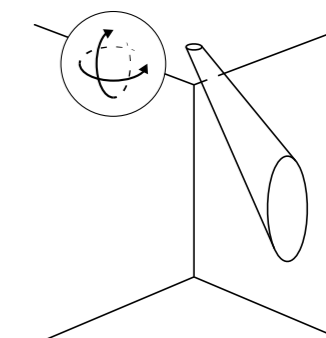

SASSO 60 adjustable

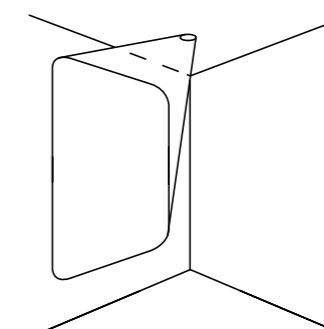

SASSO 60 wallwasher

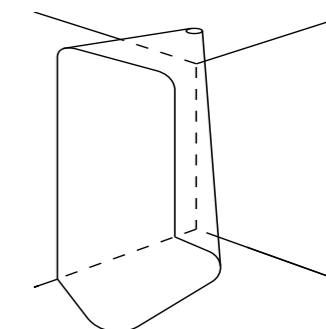

SASSO 60 wallwasher floor

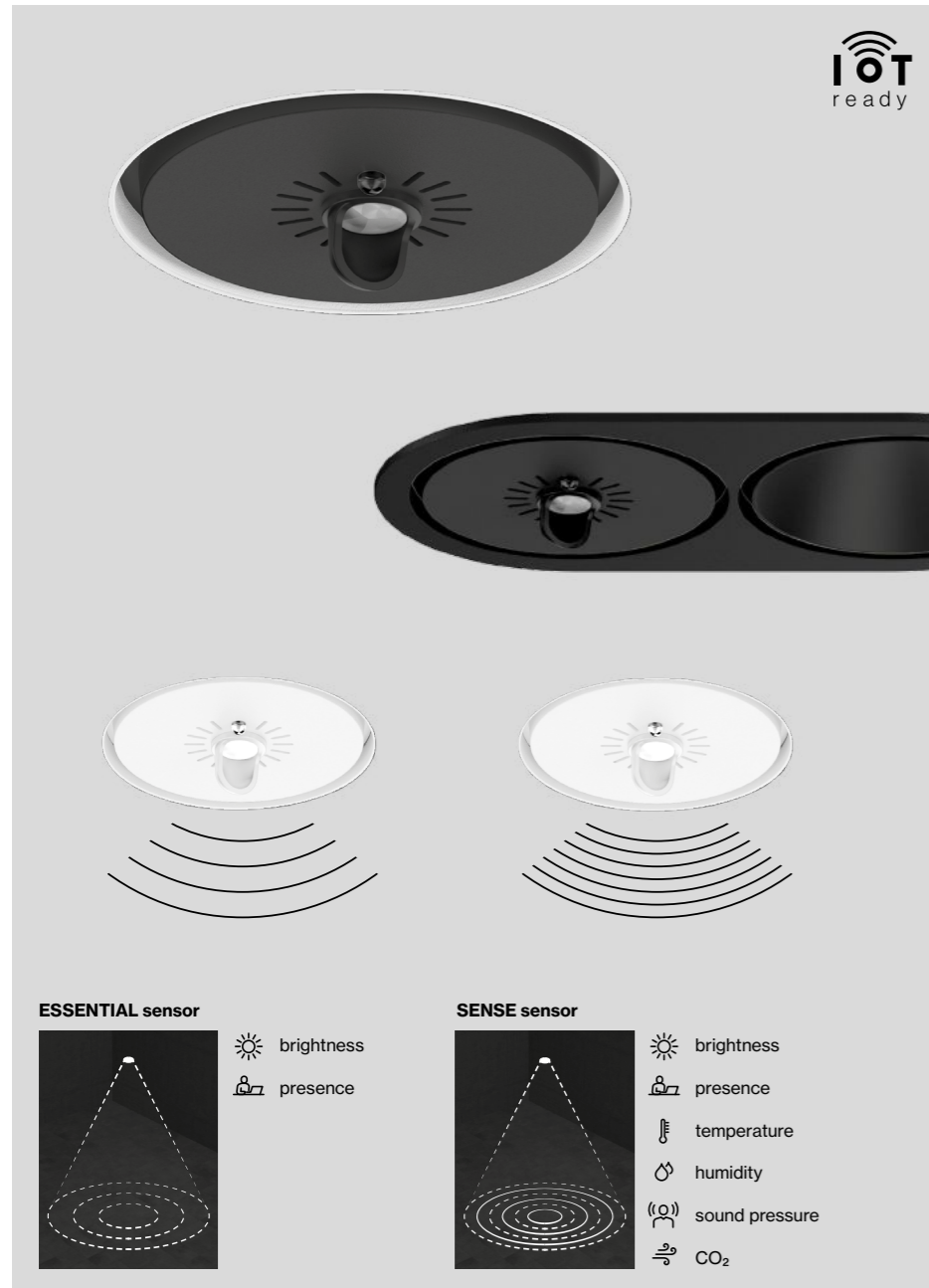

Smart lighting

EN Special sensors expand the SASSO round recessed product family with smart lighting control and collection of insightful data. The ESSENTIAL sensor enables dynamic adjustment of the lighting to ambient brightness and room activity. The SENSE version also measures values such as temperature, air quality, humidity and noise level. These data not only provide important insights into the ambient conditions and use of rooms, but also support energy savings in the long term.

DE Spezielle Sensoren erweitern die SASSO round recessed-Produktfamilie um smarte Lichtsteuerung und aufschlussreiche Datenerhebung. Der ESSENTIAL-Sensor ermöglicht die dynamische Anpassung der Beleuchtung an Umgebungshelligkeit und Raumaktivität. Die SENSE-Variante misst außerdem Werte wie Temperatur, Luftqualität, Luftfeuchtigkeit und Geräuschpegel. Diese Daten liefern nicht nur wichtige Erkenntnisse über die Umgebungsbedingungen und Nutzung von Räumen, sondern unterstützen langfristig Energieeinsparungen.

DIN Rail (DALI)

EN The DIN Rail driver centralises the power supply of several spotlights. This simplifies both the installation and maintenance of a lighting system: drivers no longer have to be installed in false ceilings, but are located collectively in a control cabinet.

More information on page 981.

DE Der DIN Rail LED Treiber zentralisiert den Stromfluss mehrerer Strahler. Dies vereinfacht sowohl die Installation als auch die Wartung einer Lichtanlage: LED Treiber müssen nicht mehr in den Zwischendecken verbaut werden, sondern befinden sich gesammelt in einem Schaltschrank.

Mehr Informationen auf Seite 981.

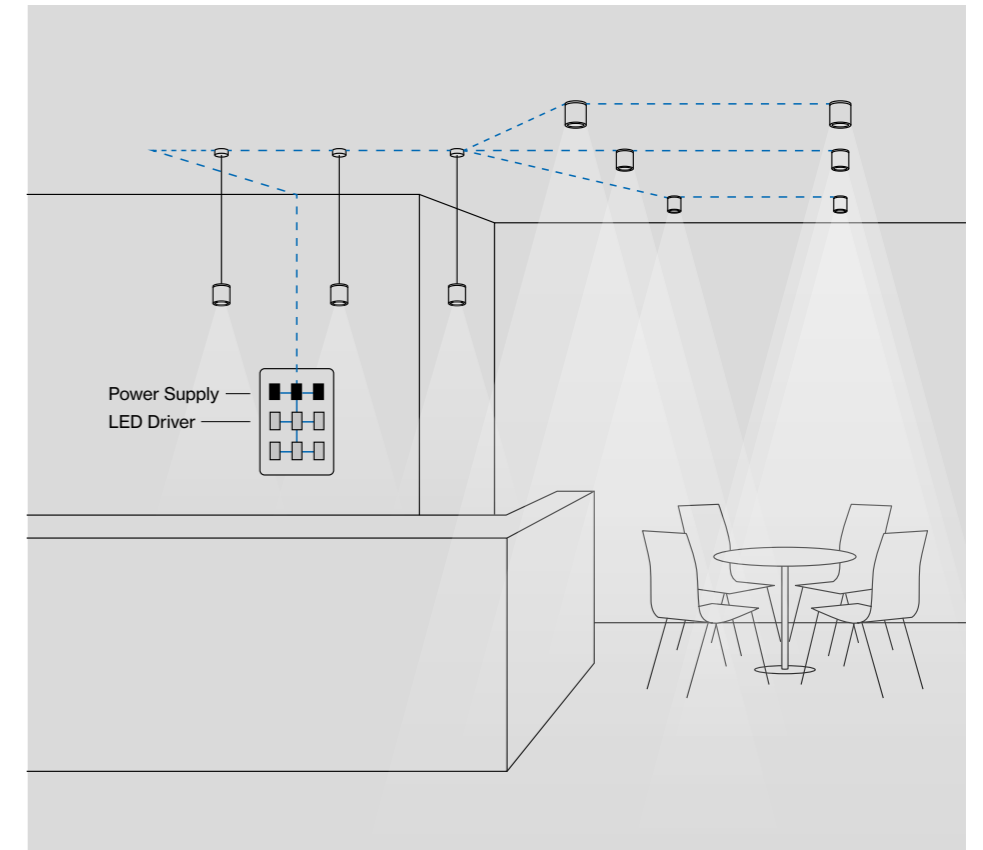

Ball catch system

EN SASSO spots are easy to replace. Assembly is quick and entirely without tools, thanks to a ball catch system. The lighting thus always adapts flexibly to new requirements and circumstances.

DE SASSO Spots sind einfach austauschbar: Die Montage erfolgt schnell und völlig ohne Werkzeug durch ein Kugelschnapsystem. So passt sich die Beleuchtung stets flexibel den neuen Anforderungen und Gegebenheiten an.

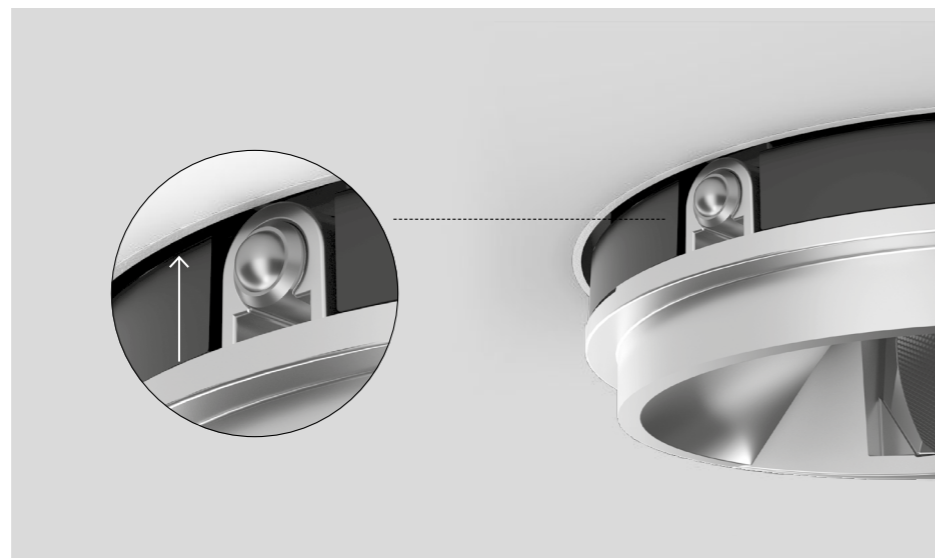

CWD – Colour Warm Dimming

EN Warm light quality with reduced illuminance. Colour Warm Dimming reduces the light intensity while continuously changing the colour temperature between 3000K and 1800K. The function supports, for example, the change between cosy restaurant lighting during the day and a relaxing lighting mood in the evening.

DE Warme Lichtqualität bei reduzierter Beleuchtungsstärke: Colour Warm Dimming senkt zugleich die Lichtintensität und wechselt die Farbtemperatur stufenlos zwischen 3000K und 1800K. Die Funktion unterstützt etwa den Wechsel zwischen gemütlicher Restaurant-Beleuchtung tagsüber und einer entspannenden Lichtstimmung am Abend.

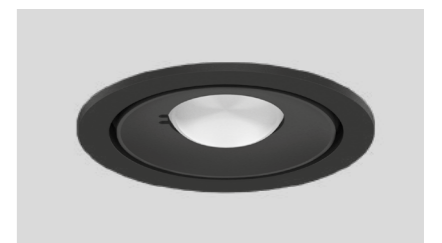

Emergency light

EN The round emergency light inset can be easily added to a lighting system without tools. The battery life is three hours – that's how long the inset can be disconnected from the power supply. It is available in three versions: BASIC provides for functional checking at the push of a button, SELF-TEST indicates functionality by means of a status LED, and in the PRO variant the status can be called up via DALI.

DE Der runde Notlicht-Einsatz lässt sich einfach werkzeuglos einer Beleuchtungsanlage hinzufügen. Die Akkulaufzeit beträgt drei Stunden – so lange kann das Inset von der Stromzufuhr getrennt sein. Erhältlich ist es in drei Varianten: BASIC sieht die Funktionsüberprüfung via Knopfdruck vor, SELF-TEST zeigt die Funktionalität durch eine Status-LED an und in der PRO-Variante ist der Status via DALI abrufbar.

← back



SASSO 40 round

recessed



EN Round recessed spotlight; installation without tools in mounting set (trimless or with trim) with ball catch system; surface lacquered; installation possible in different housings; choice of adjustable / fixed symmetric or asymmetric radiation characteristic; variants with symmetric radiation characteristic: precise radiation characteristic due to high quality lens system; variants with asymmetric radiation characteristic: high-quality reflector with micro-faceted, aluminum-vaporised surface; COB (Chip on Board) technology for maximum efficiency (ADJUSTABLE and DOWNLIGHT); no multiple shadows; efficient LEDs with very good colour rendering

DE Runder Einbaustrahler; werkzeuglose Montage im Montageset (randlos oder mit umlaufendem Rand) durch Kugelschnappsystem; Oberfläche lackiert; Einbau in unterschiedlichen Gehäusen möglich; wahlweise einstellbar / starr symmetrische oder asymmetrische Abstrahlcharakteristik; symmetrisch strahlende Varianten: präzise Abstrahlcharakteristik durch hochwertige Linsenoptik; asymmetrische strahlende Varianten: hochwertiger Reflektor mit mikrofacettierter, aluminiumbedampfter Oberfläche; COB (Chip on Board) Technologie für höchste Effizienz (ADJUSTABLE und DOWNLIGHT); keine Mehrfachschatten; effiziente LEDs mit sehr guter Farbwiedergabe

Quickinfo

2700 K, 3000 K, 4000 K
CRI ≥ 90, 2 SDCM
up to 97 lm/W
L80 @ 50 000 h
non DIM, DALI-2
↓ IP 44 / ↑ IP 20

Types

trim  
ø 44-51

trimless  
ø 48

Housing colours



Inset colours



Light distributions



Order options

COLOUR TEMPERATURE	
2700 K	4
3000 K	5
4000 K	6

INSET COLOUR	
○ traffic white RAL 9016 (UGR ≤ 22)	7
● matt silver (UGR ≤ 19)	4
● jet black RAL 9005 (UGR ≤ 16)	1
● gold dust RAL 260-M (UGR ≤ 19)	9

BEAM ANGLE	
spot 14°	S
medium 27°	M
flood 45°	F

Options on request

POWER SUPPLY
DIM 1–10 V

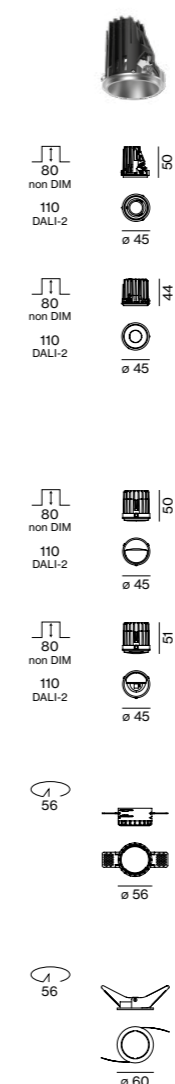

SASSO 40 round



ADJUSTABLE (↓ IP 40 / ↑ IP 20)

INSET POWER	LUMINOUS FLUX	ORDER CODE
7.4 W 36 Vf 200 mA	624 lm	0 4 8 - 2 8 2 0 :: 1 ▽ ▲

DOWNLIGHT (↑ IP 44 / ↓ IP 20)

INSET POWER	LUMINOUS FLUX	ORDER CODE
7.4 W 36 Vf 200 mA	624 lm	0 4 8 - 2 8 0 0 :: 1 ▽ ▲

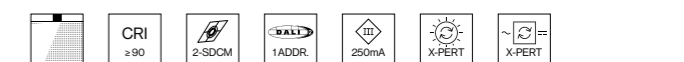

WALLWASHER (IP 20)

INSET POWER	LUMINOUS FLUX	ORDER CODE
6.8 W 27 Vf 250 mA	605 lm	0 4 8 - 2 8 4 0 :: 1 ▽ ▲

WALLWASHER / FLOOR (IP 20)

INSET POWER	LUMINOUS FLUX	ORDER CODE
6.8 W 27 Vf 250 mA	659 lm	0 4 8 - 2 8 4 0 :: 1 ▽ ▲ W

Mounting accessories

TRIMLESS MOUNTING SET for plasterboard ceilings 12.5/15/25 mm

COLOUR	ORDER CODE
○ traffic white RAL9016	0 4 8 - 2 8 9 6 1 1 7

MOUNTING SET WITH TRIM for intermediate ceilings 2–25 mm

COLOUR	ORDER CODE
○ traffic white RAL9016	0 4 8 - 2 8 9 6 3 1 7
● jet black RAL 9005	0 4 8 - 2 8 9 6 3 1 8

Electrical accessories

POWER SUPPLY 220-240 V AC, 50-60 Hz, □ PC II

TYPE	EFFICIENCY	L-W-H (mm)	ORDER CODE
200 mA non DIM	η 80 %	65-39-20	0 0 2 - 9 0 7 4 4
200 mA DALI-2	η 82 %	147-33-23	0 0 2 - 9 0 7 4 5
250 mA non DIM	η 80 %	65-39-20	0 0 2 - 9 0 7 4 2
250 mA DALI-2	η 82 %	147-33-23	0 0 2 - 9 0 7 4 3

DIN RAIL COMPONENTS

TYPE	W-H-D (mm)	ORDER CODE
POWER SUPPLY 220-240 V AC 96 W 48 V DC constant voltage	90-90-60	0 0 5 - 6 5 2 0 2 1 0
LED DRIVER DALI-2 DT6 1-2 addr. 200–1050 mA settable const. current 2 × 42 W 48 V DC U _{OUT} 10–40 V	36-88-59	0 0 5 - 6 1 2 1 0 3 0

for more details and components see page 981

Light distributions

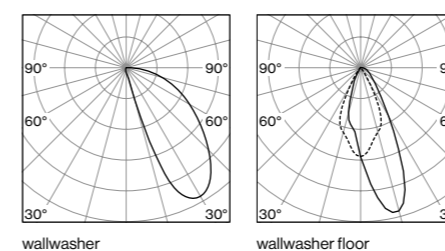

wallwasher

wallwasher floor

INSET POWER is the current consumption excluding any ballast
LUMINOUS FLUX value calculated for 3000 K, CRI ≥ 90, colour white, flood 2700 K -5%, 4000 K +5%

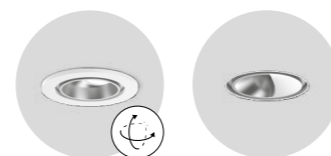

rotatable 360°,
tiltable 30°

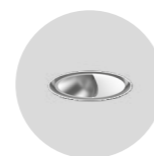

wallwasher and
ww floor inset



glare control
(UGR ≤ 16)



60 mm recess
depth (DIN rail)



Private Residence
Kreta, GR - by ROOMS GmbH



← back



SASSO 60 round

recessed

EN Round recessed spotlight; installation without tools in mounting set (trimless or with trim) with ball catch system; surface lacquered; installation possible in different housings; choice of adjustable / fixed symmetric or asymmetric radiation characteristic; variants with symmetric radiation characteristic: precise radiation characteristic due to high quality lens system; variants with asymmetric radiation characteristic: high-quality reflector with micro-faceted, aluminum-vaporised surface; COB (Chip on Board) technology for maximum efficiency (ADJUSTABLE and DOWNLIGHT); no multiple shadows; efficient LEDs with very good colour rendering

DE Runder Einbaustrahler; werkzeuglose Montage im Montageset (randlos oder mit umlaufendem Rand) durch Kugelschnappsystem; Oberfläche lackiert; Einbau in unterschiedlichen Gehäusen möglich; wahlweise einstellbar / starr symmetrische oder asymmetrische Abstrahlcharakteristik; symmetrisch strahlende Varianten: präzise Abstrahlcharakteristik durch hochwertige Linsenoptik; asymmetrische strahlende Varianten: hochwertiger Reflektor mit mikrofacettierter, aluminiumbedampfter Oberfläche; COB (Chip on Board) Technologie für höchste Effizienz (ADJUSTABLE und DOWNLIGHT); keine Mehrfachschatten; effiziente LEDs mit sehr guter Farbwiedergabe

Quickinfo

2700 K, 3000 K, 4000 K, CWD
 CRI ≥ 90, 2 SDCM
 up to 107 lm/W
 L80 @ 50 000 h
 non DIM, DALI-2
 ↓ IP 44 / ↑ IP 20

Types

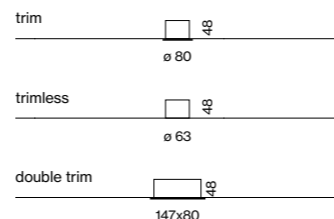

Housing colours



Inset colours



Light distributions



rotatable 360°,
tiltable 30°



wallwasher and
ww floor inset



glare control
(UGR ≤ 16)



60 mm
recess depth



CWD
1800–3000 K

Order options

COLOUR TEMPERATURE	
2700 K	4
3000 K	5
4000 K	6
CWD 1800–3000 K*	

*only for DALI-2

INSET COLOUR	
○ traffic white RAL 9016 (UGR ≤ 22)	7
● matt silver (UGR ≤ 19)	4
● jet black RAL 9005 (UGR ≤ 16)	1
● gold dust RAL 260-M (UGR ≤ 19)	9

BEAM ANGLE	
spot 15°	S
medium 21°	M
flood 42°	F

Options on request

COLOR RENDERING INDEX	
CRI ≥ 95, 2 SDCM	

CONTROL	
Casambi	

MOUNTING SET	
acoustic soft ceilings	

POWER SUPPLY	
DIM 1–10 V	

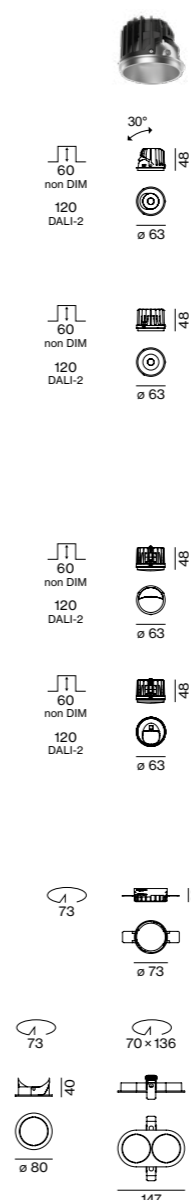

SASSO 60 round



ADJUSTABLE (↓ IP 40 / ↑ IP 20)

INSET POWER	LUMINOUS FLUX	ORDER CODE
10.7 W 36 Vf 300 mA	1040 lm	0 4 8 - 2 6 2 2 :: 1 ▣ ▲
10.4 W 35 Vf 300 mA	CWD 949 lm	0 4 8 - 2 6 2 2 E 1 ▣ ▲

DOWNLIGHT (↓ IP 44 / ↑ IP 20)

INSET POWER	LUMINOUS FLUX	ORDER CODE
10.7 W 36 Vf 300 mA	1070 lm	0 4 8 - 2 6 0 2 :: 1 ▣ ▲
10.4 W 35 Vf 300 mA	CWD 949 lm	0 4 8 - 2 6 0 2 E 1 ▣ ▲



WALLWASHER (IP 20)

INSET POWER	LUMINOUS FLUX	ORDER CODE
8.2 W 27 Vf 300 mA	635 lm	0 4 8 - 2 6 4 1 :: 1 ▣ ▲

WALLWASHER/FLOOR (IP 20)

INSET POWER	LUMINOUS FLUX	ORDER CODE
8.2 W 27 Vf 300 mA	633 lm	0 4 8 - 2 6 4 1 :: 1 ▣ ▲

Mounting accessories

TRIMLESS MOUNTING SET for plasterboard ceilings 12.5/15/25 mm

COLOUR	ORDER CODE
○ traffic white RAL9016	0 4 8 - 2 6 9 6 1 1 7

MOUNTING SET WITH TRIM for intermediate ceilings 2–25 mm

TYPE	COLOUR	ORDER CODE
1 lamp	● white aluminium RAL 9006	0 4 8 - 2 6 9 6 3 1 G
	○ traffic white RAL9016	0 4 8 - 2 6 9 6 3 1 7
	● jet black RAL 9005	0 4 8 - 2 6 9 6 3 1 8
2 lamps	● white aluminium RAL 9006	0 4 8 - 2 6 9 8 3 1 G
	○ traffic white RAL9016	0 4 8 - 2 6 9 8 3 1 7
	● jet black RAL 9005	0 4 8 - 2 6 9 8 3 1 8

CONCRETE MOUNTING HOUSING

COLOUR	L-W-H (mm)	ORDER CODE
exposed concrete ceilings	230-230-162	0 4 8 - 2 6 9 5 2 1 0
primed concrete ceilings*	614-307-120	0 4 8 - 2 6 9 5 1 1 0

*order mounting set separately, not applicable for 2 lamps mounting set with trim

Electrical accessories

POWER SUPPLY 220-240 V AC, 50-60 Hz, □ PC II

TYPE	EFFICIENCY	L-W-H (mm)	ORDER CODE
300 mA non DIM	η 85 %	85-40-22	0 0 2 - 9 0 7 7 1
300 mA DALI-2	η 88 %	143-43-30	0 0 2 - 9 0 7 6 2

DIN RAIL COMPONENTS

TYPE	W-H-D (mm)	ORDER CODE
POWER SUPPLY 220-240 V AC 96 W 48 V DC constant voltage	90-90-60	0 0 5 - 6 5 2 0 2 1 0
LED DRIVER DALI-2 DT6 1–2 addr. 200–1050 mA settable const. current	36-88-59	0 0 5 - 6 1 2 1 0 3 0

for more details and components see page 981

Light distributions

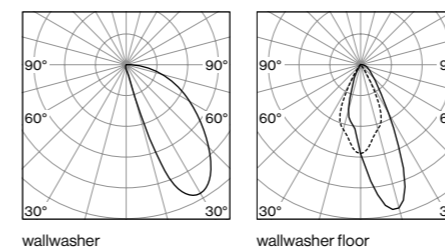

INSET POWER is the current consumption excluding any ballast
 LUMINOUS FLUX value calculated for 3000 K, CRI ≥ 90, colour white, flood 2700 K -5%, 4000 K +5%

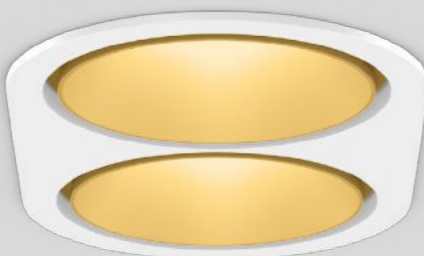
[← back](#)

SASSO 100 round

recessed

EN Round recessed spotlight; installation without tools in mounting set (trimless or with trim) with ball catch system; surface lacquered; installation possible in different housings; choice of adjustable / fixed symmetric or asymmetric radiation characteristic; variants with symmetric radiation characteristic: precise radiation characteristic due to high quality lens system; variants with asymmetric radiation characteristic: high-quality reflector with micro-faceted, aluminum-vaporised surface; COB (Chip on Board) technology for maximum efficiency (ADJUSTABLE and DOWNLIGHT); no multiple shadows; efficient LEDs with very good colour rendering

DE Runder Einbaustrahler; werkzeuglose Montage im Montageset (randlos oder mit umlaufendem Rand) durch Kugelschnappsystem; Oberfläche lackiert; Einbau in unterschiedlichen Gehäusen möglich; wahlweise einstellbar / starr symmetrische oder asymmetrische Abstrahlcharakteristik; symmetrisch strahlende Varianten: präzise Abstrahlcharakteristik durch hochwertige Linsenoptik; asymmetrische strahlende Varianten: hochwertiger Reflektor mit mikrofacettierter, aluminiumbedampfter Oberfläche; COB (Chip on Board) Technologie für höchste Effizienz (ADJUSTABLE und DOWNLIGHT); keine Mehrfachschatten; effiziente LEDs mit sehr guter Farbwiedergabe

Quickinfo

2700 K, 3000 K, 4000 K
 CRI ≥ 90, 2 SDCM
 up to 120 lm/W
 L80 @ 50 000 h
 non DIM, DALI-2
 ↓ IP 44 / ↑ IP 20

Types

trim		75 95 (depth)	ø 118
trimless		75	ø 97
double trim		75 95 (depth)	218x118

Housing colours



Inset colours



Light distributions

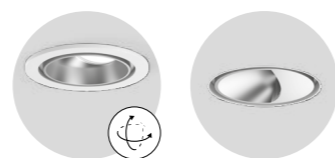

rotatable 360°, tilttable 30°



wallwasher and ww floor inset

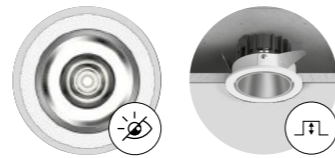

glare control (UGR ≤ 16)

80 mm recess depth

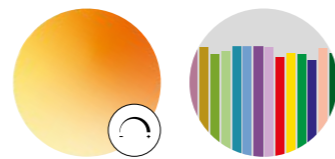
CWD
1800–3000 KCRI ≥ 95
2 SDCM

Order options

COLOUR TEMPERATURE	☐☐
2700 K	4
3000 K	5
4000 K	6

INSET COLOUR	☑
○ traffic white RAL 9016 (UGR ≤ 22)	7
● matt silver (UGR ≤ 19)	4
● jet black RAL 9005 (UGR ≤ 16)	1
● gold dust RAL 260-M (UGR ≤ 19)	9

BEAM ANGLE	▲
spot 19°	S
medium 34°	M
flood 45°	F
wide flood 65°	W

Options on request

COLOR RENDERING INDEX
 CRI ≥ 95, 2 SDCM

COLOUR TEMPERATURE
 CWD 1800–3000 K
 not for WW & WWF version

CONTROL
 Casambi

MOUNTING SET
 acoustic soft ceilings

POWER SUPPLY
 DIM 1–10 V

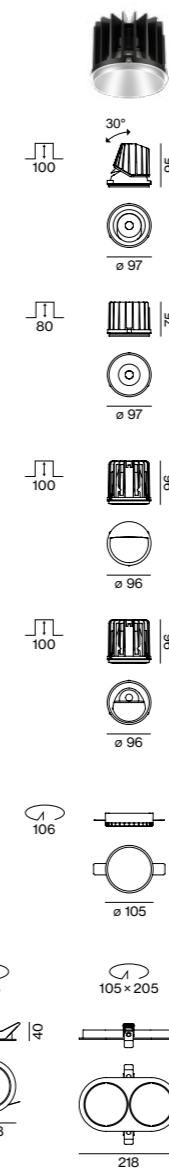

SASSO 100 round



ADJUSTABLE (↓ IP 40 / ↑ IP 20)

INSET POWER	LUMINOUS FLUX	ORDER CODE
17.2 W 36 Vf 500 mA	1850 lm	0 4 8 - 2 7 2 0 :: 1 ☑ ▲
25 W 36 Vf 700 mA	2450 lm	0 4 8 - 2 7 2 0 :: 1 ☑ ▲

DOWNLIGHT (↓ IP 44 / ↑ IP 20)

INSET POWER	LUMINOUS FLUX	ORDER CODE
17.2 W 36 Vf 500 mA	1830 lm	0 4 8 - 2 7 0 0 :: 1 ☑ ▲
25 W 36 Vf 700 mA	2410 lm	0 4 8 - 2 7 0 0 :: 1 ☑ ▲



WALLWASHER (IP 20)

INSET POWER	LUMINOUS FLUX	ORDER CODE
25 W 36 Vf 700 mA	2290 lm	0 4 8 - 2 7 4 0 :: 1 ☑ ▲

WALLWASHER/FLOOR (IP 20)

INSET POWER	LUMINOUS FLUX	ORDER CODE
23.4 W 36 Vf 700 mA	2670 lm	0 4 8 - 2 7 4 0 :: 1 ☑ ▲

Mounting accessories

TRIMLESS MOUNTING SET for plasterboard ceilings 12.5/15/25 mm

COLOUR	ORDER CODE
○ traffic white RAL9016	0 4 8 - 2 7 9 6 1 1 7

MOUNTING SET WITH TRIM for intermediate ceilings 2–25 mm

TYPE	COLOUR	ORDER CODE
1 lamp	● white aluminium RAL 9006	0 4 8 - 2 7 9 6 3 1 G
	○ traffic white RAL9016	0 4 8 - 2 7 9 6 3 1 7
	● jet black RAL 9005	0 4 8 - 2 7 9 6 3 1 8
2 lamps	● white aluminium RAL 9006	0 4 8 - 2 7 9 8 3 1 G
	○ traffic white RAL9016	0 4 8 - 2 7 9 8 3 1 7
	● jet black RAL 9005	0 4 8 - 2 7 9 8 3 1 8

CONCRETE MOUNTING HOUSING

COLOUR	L-W-H (mm)	ORDER CODE
exposed concrete ceilings	230-230-162	0 4 8 - 2 7 9 5 2 1 0
primed concrete ceilings*	614-307-120	0 4 8 - 2 6 9 5 1 1 0

*order mounting set separately, not applicable for 2 lamps mounting set with trim

Electrical accessories

POWER SUPPLY 220-240 V AC, 50-60 Hz, ☐ PC II

TYPE	EFFICIENCY	L-W-H (mm)	ORDER CODE
500 mA non DIM	η 88 %	143-43-30	0 0 2 - 9 0 7 7 7
500 mA DALI-2	η 88 %	143-43-30	0 0 2 - 9 0 7 7 9
700 mA non DIM	η 80 %	143-43-30	0 0 2 - 9 0 7 7 4
700 mA DALI-2	η 88 %	143-43-30	0 0 2 - 9 0 7 7 6

THROUGH WIRING CONNECTION BOX

TYPE	L-W-H (mm)	ORDER CODE
non DIM cable ø 4–12 mm	105-58-30	0 0 5 - 2 5 3 1 1 1 0
DALI cable ø 4–12 mm	105-58-30	0 0 5 - 2 5 5 1 1 1 0

DIN RAIL COMPONENTS

TYPE	W-H-D (mm)	ORDER CODE
POWER SUPPLY 220-240 V AC 96 W 48 V DC constant voltage	90-90-60	0 0 5 - 6 5 2 0 2 1 0
LED DRIVER DALI-2 DT6 1–2 addr. 200–1050 mA settable const. current 2 × 42 W 48 V DC U _{OUT} 10–40 V	36-88-59	0 0 5 - 6 1 2 1 0 3 0

for more details and components see page 981

INSET POWER is the current consumption excluding any ballast
LUMINOUS FLUX value calculated for 3000 K, CRI ≥ 90, colour white, wide flood
 2700 K -5%, 4000 K +5%

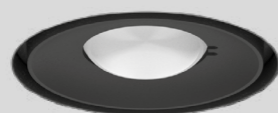

SASSO 60 round sensor/emergency

recessed

EN Round inset (Emergency Light or Sensor); installation without tools in mounting set (trimless or with trim) with ball catch system; surface lacquered; installation possible in different housings; LED emergency light inset: 3 variants with different test possibilities - BASIC with test button, SELF-TEST with status LED or PRO DALI-2 with monitoring via DALI; sensor with DALI-2 control: 2 variants - ESSENTIAL with brightness and presence sensor or SENSE with additional temperature, humidity, air quality and noise level measurement

DE Runder Einsatz (Notlicht bzw. Sensor); werkzeuglose Montage im Montageset (randlos oder mit umlaufendem Rand) durch Kugelschnappsystem; Oberfläche lackiert; Einbau in unterschiedlichen Gehäusen möglich; LED Notlicht-Einsatz: 3 Varianten mit verschiedenen Testmöglichkeiten - BASIC mit Prüftaste, SELF-TEST mit Status-LED oder PRO DALI-2 mit Überwachung über DALI; Sensor mit DALI-2 Steuerung: 2 Varianten - ESSENTIAL mit Helligkeits- und Anwesenheitssensor oder SENSE mit zusätzlicher Temperatur-, Luftfeuchtigkeits-, Luftqualitäts- und Lärmpegelmessung

Quickinfo

sensor
ESSENTIAL, SENSE
DALI-2

emergency light
6500K
CRI ≥ 80
200lm
L80 @ 50000h
non maintained

Types

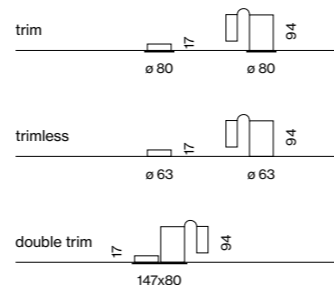

Housing colours



Inset colours



Sensors



Order options

INSET COLOUR
 traffic white RAL 9016 7
 jet black RAL 9005 1

BEAM ANGLE EMERGENCY LIGHT

spot lens
escape route lens
anti panic lens

Options on request

MOUNTING SET

acoustic soft ceilings

INSET COLOUR

grey, gold

Light distributions

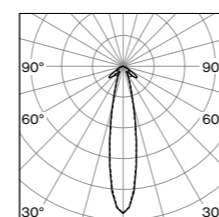

emergency light
spot lens

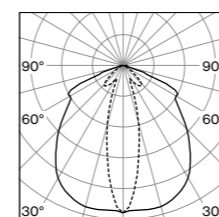

emergency light
escape route lens

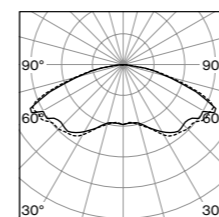

emergency light
anti panic lens

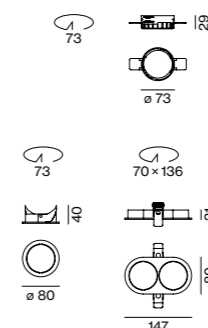

SASSO 60 sensor round



ESSENTIAL SENSOR

TYPE
brightness & presence **ORDER CODE**
048-269311



SENSE SENSOR

TYPE
brightness, presence, temperature,
sound pressure, humidity, CO₂ **ORDER CODE**
048-269312

SASSO 60 emergency light round



EMERGENCY 3h

TYPE
BASIC | 2W **ORDER CODE** 048-269321
SELF-TEST | 2W **ORDER CODE** 048-269322
PRO DALI-2 | 2W **ORDER CODE** 048-269323
incl. 3 interchangeable lenses

Electrical accessories

ACCUPACK

TYPE
replacement accupack 3h **ORDER CODE**
048-2693910

Mounting accessories

TRIMLESS MOUNTING SET for plasterboard ceilings 12.5/15/25mm

COLOUR
 traffic white RAL9016 **ORDER CODE** 048-2696117

MOUNTING SET WITH TRIM for intermediate ceilings 2-25mm

TYPE **COLOUR** **ORDER CODE**
1 lamp traffic white RAL9016 048-2696317
 jet black RAL 9005 048-2696318
2 lamps traffic white RAL9016 048-2698317
 jet black RAL 9005 048-2698318

CONCRETE MOUNTING HOUSING

COLOUR **L-W-H (mm)** **ORDER CODE**
exposed concrete ceilings 230-230-162 048-2695210
primed concrete ceilings* 614-307-120 048-2695110

*order mounting set separately, not applicable for 2 lamps mounting set with trim



Deansgate Square Manchester, UK –
by Lister & Lister with lighting design
by Troup, Bywaters & Anders Lighting

Deansgate Square Manchester, UK –
by Lister & Lister with lighting design
by Troup, Bywaters & Anders Lighting



HeidelbergCement AG
Heidelberg, DE – by Albert Speer +
Partner Architekten with lighting
design by Hailight Lichtplanung,
Andreas Haidegger





Oppenländer Rechtsanwälte
Stuttgart, DE – by Ippolito Fleitz
Group GmbH



← back

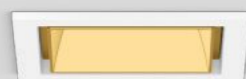
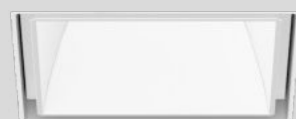

SASSO 60 square

recessed







EN Square recessed spotlight; installation without tools in mounting set (trimless or with trim) with ball catch system; surface lacquered; installation possible in different housings; choice of fixed symmetric or asymmetric radiation characteristic; variants with symmetric radiation characteristic: precise radiation characteristic due to high quality lens system; variants with asymmetric radiation characteristic: high-quality reflector with micro-faceted, aluminum-vaporised surface; COB (Chip on Board) technology for maximum efficiency (DOWNLIGHT); no multiple shadows; efficient LEDs with very good colour rendering

DE Quadratischer Einbaustrahler; werkzeuglose Montage im Montageset (randlos oder mit umlaufendem Rand) durch Kugelschnapsystem; Oberfläche lackiert; Einbau in unterschiedlichen Gehäusen möglich; wahlweise starr symmetrische oder asymmetrische Abstrahlcharakteristik; symmetrisch strahlende Varianten: präzise Abstrahlcharakteristik durch hochwertige Linsenoptik; asymmetrische strahlende Varianten: hochwertiger Reflektor mit mikrofaccettierter, aluminiumbedampfter Oberfläche; COB (Chip on Board) Technologie für höchste Effizienz (DOWNLIGHT); keine Mehrfachschatten; effiziente LEDs mit sehr guter Farbwiedergabe

Quickinfo

2700 K, 3000 K, 4000 K, CWD
CRI ≥ 90, 2 SDCM
up to 110 lm/W
L80 @ 50 000 h
non DIM, DALI-2
↓ IP 44 / ↑ IP 20

Types

trim		48
		80
trimless		48
		63
double trim		48
		147x81

Housing colours



Inset colours



Light distributions



wallwasher and
ww floor inset



glare control
(UGR ≤ 16)

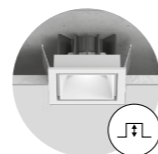

60 mm
recess depth



CWD
1800-3000 K



CRI ≥ 95
2 SDCM

Order options

COLOUR TEMPERATURE	☼☼☼
2700 K	4
3000 K	5
4000 K	6
CWD 1800-3000 K*	

*only for DALI-2

INSET COLOUR

○ traffic white RAL 9016 (UGR ≤ 22)	7
● matt silver (UGR ≤ 19)	4
● jet black RAL 9005 (UGR ≤ 16)	1
● gold dust RAL 260-M (UGR ≤ 19)	9

BEAM ANGLE

spot 15°	S
medium 21°	M
flood 42°	F

Options on request

COLOR RENDERING INDEX

CRI ≥ 95, 2 SDCM

CONTROL

Casambi

MOUNTING SET

acoustic soft ceilings

POWER SUPPLY

DIM 1-10 V

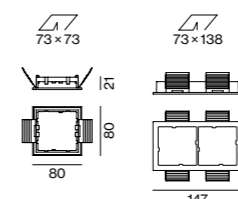
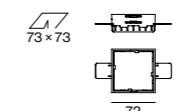
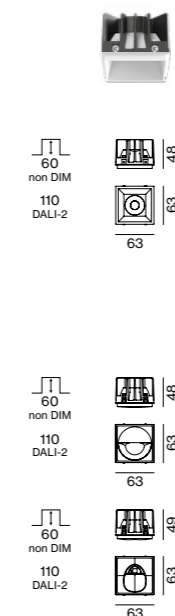

SASSO 60 square



DOWNLIGHT (↓ IP 44 / ↑ IP 20)

INSET POWER	LUMINOUS FLUX	ORDER CODE
10.7 W 36 Vf 300 mA	1180 lm	0 4 8 - 2 6 1 2 :: 1 ▽ ▲
10.4 W 35 Vf 300 mA	CWD 949 lm	0 4 8 - 2 6 1 2 E 1 ▽ ▲



WALLWASHER (IP 20)

INSET POWER	LUMINOUS FLUX	ORDER CODE
8.2 W 27 Vf 300 mA	635 lm	0 4 8 - 2 6 5 1 :: 1 ▽ ▲

WALLWASHER/FLOOR (IP 20)

INSET POWER	LUMINOUS FLUX	ORDER CODE
8.2 W 27 Vf 300 mA	633 lm	0 4 8 - 2 6 5 1 :: 1 ▽ ▲ W

Mounting accessories

TRIMLESS MOUNTING SET for plasterboard ceilings 12.5/15/25 mm

COLOUR	ORDER CODE
○ traffic white RAL9016	0 4 8 - 2 6 9 7 1 1 7

MOUNTING SET WITH TRIM for intermediate ceilings 2-25 mm

TYPE	COLOUR	ORDER CODE
1 lamp	● white aluminium RAL 9006	0 4 8 - 2 6 9 7 3 1 G
	○ traffic white RAL9016	0 4 8 - 2 6 9 7 3 1 7
	● jet black RAL 9005	0 4 8 - 2 6 9 7 3 1 8
2 lamps	● white aluminium RAL 9006	0 4 8 - 2 6 9 9 3 1 G
	○ traffic white RAL9016	0 4 8 - 2 6 9 9 3 1 7
	● jet black RAL 9005	0 4 8 - 2 6 9 9 3 1 8

CONCRETE MOUNTING HOUSING

COLOUR	L-W-H (mm)	ORDER CODE
primed concrete ceilings*	614-307-120	0 4 8 - 2 6 9 5 1 1 0

*order mounting set separately, not applicable for 2 lamps mounting set with trim

Electrical accessories

POWER SUPPLY 220-240 V AC, 50-60 Hz, □ PC II

TYPE	EFFICIENCY	L-W-H (mm)	ORDER CODE
300 mA non DIM	η 85 %	85-40-22	0 0 2 - 9 0 7 7 1
300 mA DALI-2	η 88 %	143-43-30	0 0 2 - 9 0 7 6 2

THROUGH WIRING CONNECTION BOX

TYPE	L-W-H (mm)	ORDER CODE
non DIM cable ø 4-12 mm	105-58-30	0 0 5 - 2 5 3 1 1 1 0
DALI cable ø 4-12 mm	105-58-30	0 0 5 - 2 5 5 1 1 1 0

DIN RAIL COMPONENTS

TYPE	W-H-D (mm)	ORDER CODE
POWER SUPPLY 220-240 V AC	90-90-60	0 0 5 - 6 5 2 0 2 1 0
96 W 48V DC constant voltage		
LED DRIVER DALI-2 DT6 1-2 addr.	36-88-59	0 0 5 - 6 1 2 1 0 3 0
200-1050 mA settable const. current		
2 × 42 W 48 V DC U _{OUT} 10-40 V		

for more details and components see page 981

Light distributions

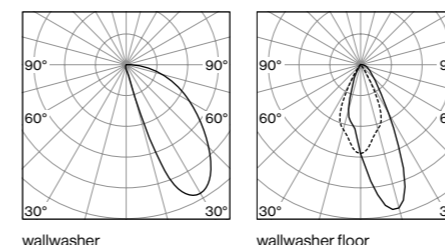

wallwasher

wallwasher floor

INSET POWER is the current consumption excluding any ballast
LUMINOUS FLUX value calculated for 3000 K, CRI ≥ 90, colour white, flood 2700 K -5%, 4000 K +5%

← back

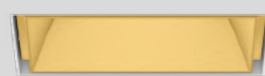
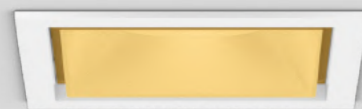

SASSO 100 square

recessed

EN Square recessed spotlight; installation without tools in mounting set (trimless or with trim) with ball catch system; surface lacquered; installation possible in different housings; choice of adjustable / fixed symmetric or asymmetric radiation characteristic; variants with symmetric radiation characteristic: precise radiation characteristic due to high quality lens system; variants with asymmetric radiation characteristic: high-quality reflector with micro-faceted, aluminum-vaporised surface; COB (Chip on Board) technology for maximum efficiency (ADJUSTABLE and DOWNLIGHT); no multiple shadows; efficient LEDs with very good colour rendering

DE Quadratischer Einbaustrahler; werkzeuglose Montage im Montageset (randlos oder mit umlaufendem Rand) durch Kugelschnapsystem; Oberfläche lackiert; Einbau in unterschiedlichen Gehäusen möglich; wahlweise einstellbar / starr symmetrische oder asymmetrische Abstrahlcharakteristik; symmetrisch strahlende Varianten: präzise Abstrahlcharakteristik durch hochwertige Linsenoptik; asymmetrische strahlende Varianten: hochwertiger Reflektor mit mikrofacettierter, aluminiumbedampfter Oberfläche; COB (Chip on Board) Technologie für höchste Effizienz (ADJUSTABLE und DOWNLIGHT); keine Mehrfachschatten; effiziente LEDs mit sehr guter Farbwiedergabe

Quickinfo

2700 K, 3000 K, 4000 K
CRI ≥ 90, 2 SDCM
up to 120 lm/W
L80 @ 50 000 h
non DIM, DALI-2
↓ IP 44 / ↑ IP 20

Types

trim		75	95 (incl.)
		118	
trimless		75	95 (incl.)
		97	
double trim		75	95 (incl.)
		218x118	

Housing colours



Inset colours



Light distributions



wallwasher and
ww floor inset



glare control
(UGR ≤ 16)

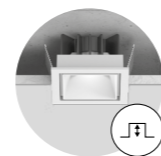

60 mm
recess depth



CWD
1800-3000 K



CRI ≥ 95
2 SDCM

Order options

COLOUR TEMPERATURE	☐☐☐
2700 K	4
3000 K	5
4000 K	6

INSET COLOUR	☑
☐ traffic white RAL 9016 (UGR ≤ 22)	7
● matt silver (UGR ≤ 19)	4
● jet black RAL 9005 (UGR ≤ 16)	1
● gold dust RAL 260-M (UGR ≤ 19)	9

BEAM ANGLE	▲
spot 19°	S
medium 34°	M
flood 45°	F
wide flood 65°	W

Options on request

COLOR RENDERING INDEX
CRI ≥ 95, 2 SDCM

COLOUR TEMPERATURE
CWD 1800-3000 K
not for WW & WWF version

CONTROL

Casambi

MOUNTING SET

acoustic soft ceilings

POWER SUPPLY

DIM 1-10 V

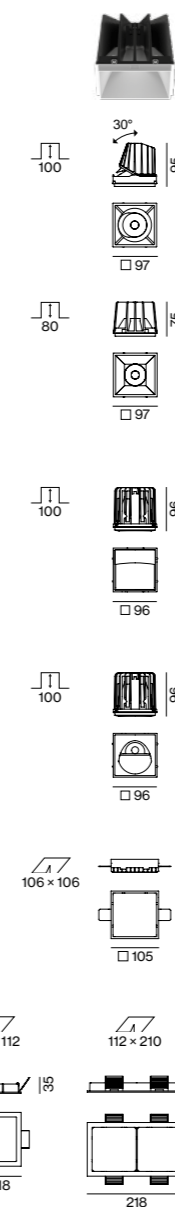

Light distributions

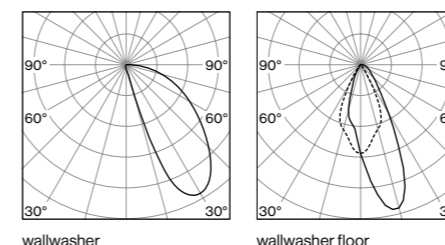

INSET POWER is the current consumption excluding any ballast
LUMINOUS FLUX value calculated for 3000 K, CRI ≥ 90, colour white, wide flood
2700 K -5%, 4000 K +5%

SASSO 100 square



ADJUSTABLE (↓ IP 40 / ↑ IP 20)

INSET POWER	LUMINOUS FLUX	ORDER CODE
17.2 W 36 Vf 500 mA	1860 lm	0 4 8 - 2 7 3 0 :: 1 ☑ ▲
25 W 36 Vf 700 mA	2450 lm	0 4 8 - 2 7 3 0 :: 1 ☑ ▲

DOWNLIGHT (↓ IP 44 / ↑ IP 20)

INSET POWER	LUMINOUS FLUX	ORDER CODE
17.2 W 36 Vf 500 mA	1890 lm	0 4 8 - 2 7 1 0 :: 1 ☑ ▲
25 W 36 Vf 700 mA	2500 lm	0 4 8 - 2 7 1 0 :: 1 ☑ ▲



WALLWASHER (IP 20)

INSET POWER	LUMINOUS FLUX	ORDER CODE
25 W 36 Vf 700 mA	2290 lm	0 4 8 - 2 7 5 0 :: 1 ☑ ▲

WALLWASHER/FLOOR (IP 20)

INSET POWER	LUMINOUS FLUX	ORDER CODE
23.4 W 36 Vf 700 mA	2670 lm	0 4 8 - 2 7 5 0 :: 1 ☑ ▲

Mounting accessories

TRIMLESS MOUNTING SET for plasterboard ceilings 12.5/15/25 mm

COLOUR	ORDER CODE
☐ traffic white RAL9016	0 4 8 - 2 7 9 7 1 1 7

MOUNTING SET WITH TRIM for intermediate ceilings 2-25 mm

TYPE	COLOUR	ORDER CODE
1 lamp	● white aluminium RAL 9006	0 4 8 - 2 7 9 7 3 1 G
	☐ traffic white RAL9016	0 4 8 - 2 7 9 7 3 1 7
	● jet black RAL 9005	0 4 8 - 2 7 9 7 3 1 8
2 lamps	● white aluminium RAL 9006	0 4 8 - 2 7 9 9 3 1 G
	☐ traffic white RAL9016	0 4 8 - 2 7 9 9 3 1 7
	● jet black RAL 9005	0 4 8 - 2 7 9 9 3 1 8

CONCRETE MOUNTING HOUSING

COLOUR	L-W-H (mm)	ORDER CODE
primed concrete ceilings*	614-307-120	0 4 8 - 2 6 9 5 1 1 0

*order mounting set separately, not applicable for 2 lamps mounting set with trim

Electrical accessories

POWER SUPPLY 220-240 V AC, 50-60 Hz, ☐ PC II

TYPE	EFFICIENCY	L-W-H (mm)	ORDER CODE
500 mA non DIM	η 88 %	143-43-30	0 0 2 - 9 0 7 7 7
500 mA DALI-2	η 88 %	143-43-30	0 0 2 - 9 0 7 7 9
700 mA non DIM	η 80 %	143-43-30	0 0 2 - 9 0 7 7 4
700 mA DALI-2	η 88 %	143-43-30	0 0 2 - 9 0 7 7 6

THROUGH WIRING CONNECTION BOX

TYPE	L-W-H (mm)	ORDER CODE
non DIM cable ø 4-12 mm	105-58-30	0 0 5 - 2 5 3 1 1 1 0
DALI cable ø 4-12 mm	105-58-30	0 0 5 - 2 5 5 1 1 1 0

DIN RAIL COMPONENTS

TYPE	W-H-D (mm)	ORDER CODE
POWER SUPPLY 220-240 V AC 96 W 48 V DC constant voltage	90-90-60	0 0 5 - 6 5 2 0 2 1 0
LED DRIVER DALI-2 DT6 1-2 addr. 200-1050 mA settable const. current 2 × 42 W 48 V DC U _{OUT} 10-40 V	36-88-59	0 0 5 - 6 1 2 1 0 3 0

for more details and components see page 981

Zeitgeist Graz, AT –
by FIPE ARCHITECTURE



← back

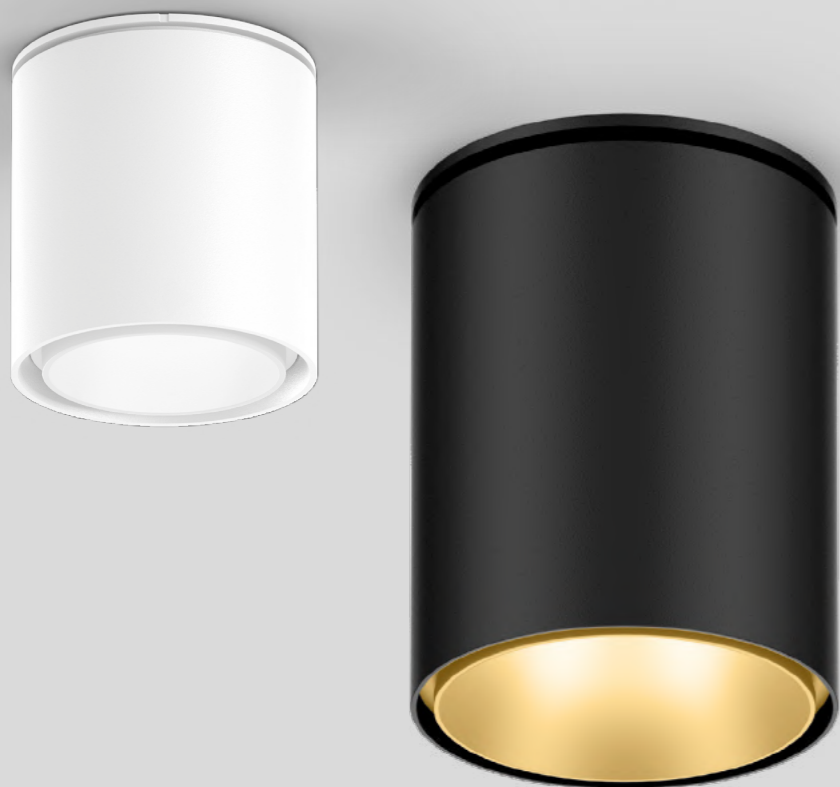

SASSO 60/100 round

semi-recessed

EN Cylindrical semi-recessed spotlight made of aluminium, available in 2 sizes; light inset lacquered; housing powder coated; luminaire housing can be attached to mounting plate without tools by interlock; choice of adj. sym. or asym. radiation characteristic; variants with sym. radiation characteristic: precise due to high quality lens system; variants with asym. radiation characteristic: high-quality reflector with micro-faceted, aluminum-vaporised surface; COB (Chip on Board) technology for maximum efficiency (ADJUSTABLE); no multiple shadows; efficient LEDs with very good colour rendering; external converter for ceiling insertion, for through-wiring suitable

DE Zylindrischer Halbeinbaustrahler aus Aluminium in 2 Größen; Lichteinsatz lackiert; Gehäuse pulverbeschichtet; Leuchtenkörper mittels Verriegelung werkzeuglos auf Montageplatte aufsetzbar; wahlweise einstellbar sym. oder asym. Abstrahlcharakteristik; sym. strahlende Varianten: präzise durch hochwertige Linsensystem; asym. strahlende Varianten: hochwertiger Reflektor mit mikrofacettierter, aluminiumbedampfter Oberfläche; COB (Chip on Board) Technologie für höchste Effizienz (ADJUSTABLE); keine Mehrfachschatten; effiziente LEDs mit sehr guter Farbwiedergabe; externer Konverter für Deckeneinwurf, für Weiterverdrahtung geeignet

Quickinfo

2700 K, 3000 K, 4000 K
CRI ≥ 90, 2 SDCM
SASSO 60 up to 104 lm/W
SASSO 100 up to 117 lm/W
L80 @ 50 000 h
non DIM, DALI-2

Types

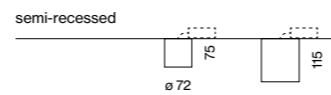

Housing colours



Inset colours



Light distributions

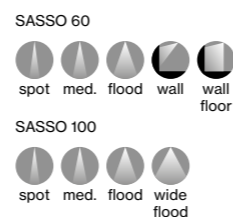

wallwasher and
ww floor inset

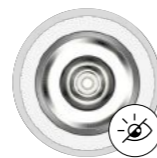

glare control
(UGR ≤ 16)



easy mounting;
no visible screws



CWD
1800–3000 K



CRI ≥ 95
2 SDCM

Order options

COLOUR TEMPERATURE	
2700 K	4
3000 K	5
4000 K	6

HOUSING COLOUR	
○ traffic white RAL 9016	7
● jet black RAL 9005	1

INSET COLOUR	
○ traffic white RAL 9016 (UGR ≤ 22)	7
● matt silver (UGR ≤ 19)	4
● jet black RAL 9005 (UGR ≤ 16)	1
● gold dust RAL 260-M (UGR ≤ 19)	9

BEAM ANGLE SASSO 60	
spot 15°	S
medium 21°	M
flood 42°	F

BEAM ANGLE SASSO 100	
spot 19°	S
medium 34°	M
flood 45°	F
wide flood 65°	W

Options on request

COLOUR RENDERING INDEX
CRI ≥ 95, 2 SDCM

COLOUR TEMPERATURE

CWD 1800–3000 K
not for WW & WWF version

CONTROL

Casambi

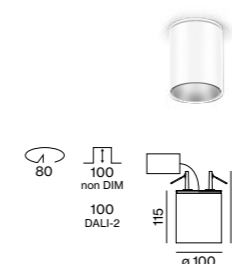
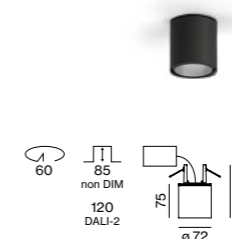

SASSO 60 round semi-recessed



ADJUSTABLE

INSET POWER	LUMINOUS FLUX	ORDER CODE
10.7 W 36 Vf 300 mA	1040 lm	0 4 8 - 3 1 0 1 :: 1 ■ ■ ▲



WALLWASHER

INSET POWER	LUMINOUS FLUX	ORDER CODE
8.2 W 27 Vf 300 mA	635 lm	0 4 8 - 3 7 0 1 :: 1 ■ ■ ▲

WALLWASHER/FLOOR

INSET POWER	LUMINOUS FLUX	ORDER CODE
8.2 W 27 Vf 300 mA	633 lm	0 4 8 - 3 7 0 1 :: 1 ■ ■ ▲

SASSO 100 round semi-recessed



ADJUSTABLE

INSET POWER	LUMINOUS FLUX	ORDER CODE
17.2 W 36 Vf 500 mA	1850 lm*	0 4 8 - 3 4 0 1 :: 1 ■ ■ ▲

*reflector white flood

Electrical accessories

POWER SUPPLY 220-240 V AC, 50-60 Hz, PC II

TYPE	EFFICIENCY	L-WH (mm)	ORDER CODE
300 mA non DIM	η 85 %	85-40-22	0 0 2 - 9 0 7 7 1
300 mA DALI-2	η 88 %	143-43-30	0 0 2 - 9 0 7 6 2
500 mA non DIM	η 88 %	143-43-30	0 0 2 - 9 0 7 7 7
500 mA DALI-2	η 88 %	143-43-30	0 0 2 - 9 0 7 7 9

THROUGH WIRING CONNECTION BOX for SASSO 100

TYPE	L-WH (mm)	ORDER CODE
non DIM cable ø 4–12 mm	105-58-30	0 0 5 - 2 5 3 1 1 1 0
DALI cable ø 4–12 mm	105-58-30	0 0 5 - 2 5 5 1 1 1 0

DIN RAIL COMPONENTS

TYPE	WHD (mm)	ORDER CODE
POWER SUPPLY 220-240 V AC 96 W 48V DC constant voltage	90-90-60	0 0 5 - 6 5 2 0 2 1 0
LED DRIVER DALI-2 DT6 1–2 addr. 200–1050 mA settable const. current 2 × 42 W 48 V DC U _{OUT} 10–40 V	36-88-59	0 0 5 - 6 1 2 1 0 3 0

for more details and components see page 981

INSET POWER is the current consumption excluding any ballast
LUMINOUS FLUX value calculated for 3000 K, CRI ≥ 90, colour white, flood 2700 K -5%, 4000 K +5%

[← back](#)

SASSO 60/100 round

ceiling

EN Cylindrical ceiling mounted spotlight made of aluminium, available in 2 sizes; light inset lacquered; housing powder coated; luminaire housing can be attached to mounting plate without tools by interlock; adj. sym. or asym. radiation characteristic; variants with sym. radiation characteristic: precise due to high quality lens system; variants with asym. radiation characteristic: high-quality reflector with micro-faceted, aluminum-vaporised surface; COB (Chip on Board) technology for maximum efficiency (ADJUSTABLE); no multiple shadows; efficient LEDs with very good colour rendering; converter integrated into spotlight head

DE Zylindrischer Deckenanbaustrahler aus Aluminium in 2 Größen; Lichteinsatz lackiert; Gehäuse pulverbeschichtet; Leuchtenkörper mittels Verriegelung werkzeuglos auf Montageplatte aufsetzbar; einstellbar sym. oder asym. Abstrahlcharakteristik; sym. strahlende Varianten: präzise durch hochwertige Linsensystem; asym. strahlende Varianten: hochwertiger Reflektor mit mikrofacettierter, aluminiumbedampfter Oberfläche; COB (Chip on Board) Technologie für höchste Effizienz (ADJUSTABLE); keine Mehrfachschatten; effiziente LEDs mit sehr guter Farbwiedergabe; Konverter im Strahlerkopf integriert

Quickinfo

2700 K, 3000 K, 4000 K
 CRI ≥ 90, 2 SDCM
 SASSO 60 up to 81lm/W
 SASSO 100 up to 100lm/W
 L80 @ 50 000 h
 non DIM, DALI-2

Types

ceiling

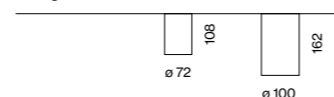

Housing colours



Inset colours



Light distributions

SASSO 60



SASSO 100



wallwasher and
ww floor inset

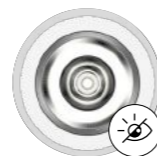

glare control
(UGR ≤ 16)



easy mounting;
no visible screws



CWD
1800–3000 K



CRI ≥ 95
2 SDCM

Order options

COLOUR TEMPERATURE	
2700 K	4
3000 K	5
4000 K	6

CONTROL	
non DIM	1
DALI-2	3

HOUSING COLOUR	
○ traffic white RAL 9016	7
● jet black RAL 9005	1

INSET COLOUR	
○ traffic white RAL 9016 (UGR ≤ 22)	7
● matt silver (UGR ≤ 19)	4
● jet black RAL 9005 (UGR ≤ 16)	1
● gold dust RAL 260-M (UGR ≤ 19)	9

BEAM ANGLE	
SASSO 60	▲
spot 15°	S
medium 21°	M
flood 42°	F

BEAM ANGLE	
SASSO 100	▲
spot 19°	S
medium 34°	M
flood 45°	F
wide flood 65°	W

Options on request

COLOUR RENDERING INDEX
 CRI ≥ 95, 2 SDCM

COLOUR TEMPERATURE
 CWD 1800–3000 K
 not for WW & WWF version

LUMINOUS FLUX value calculated for
 CRI ≥ 90, colour white, reflector flood



SASSO 60 round ceiling



ADJUSTABLE

SYSTEM POWER	COLOUR TEMP.	LUMINOUS FLUX	ORDER CODE
11.6 W	2700 K	808 lm	0 4 8 - 3 1 1 0 :: ◆ ▣ ▣ ▲
	3000 K	874 lm	
	4000 K	939 lm	



WALLWASHER

SYSTEM POWER	COLOUR TEMP.	LUMINOUS FLUX	ORDER CODE
11.4 W	2700 K	635 lm	0 4 8 - 3 7 1 0 :: ◆ ▣ ▣ A
	3000 K	635 lm	
	4000 K	744 lm	

WALLWASHER/FLOOR

SYSTEM POWER	COLOUR TEMP.	LUMINOUS FLUX	ORDER CODE
11.4 W	2700 K	633 lm	0 4 8 - 3 7 1 0 :: ◆ ▣ ▣ W
	3000 K	633 lm	
	4000 K	746 lm	

SASSO 100 round ceiling



ADJUSTABLE

SYSTEM POWER	COLOUR TEMP.	LUMINOUS FLUX	ORDER CODE
20.2 W	2700 K	1650 lm	0 4 8 - 3 4 1 0 :: ◆ ▣ ▣ ▲
	3000 K	1790 lm	
	4000 K	1930 lm	

Oppenländer Rechtsanwälte
Stuttgart, DE – by Ippolito Fleitz
Group GmbH



WIKUS Sägenfabrik Spangenberg, DE –
by Bieling Architekten AG with lighting
design by Peter Andres Unabhängige
Lichtplanung und -beratung GbR



Private Residence
Copenhagen, DK –
by COBE Architects with
lighting design by anker & co



← back



SASSO 60/100 square

semi-recessed

EN Square semi-recessed spotlight made of aluminium, available in 2 sizes; light inset lacquered; housing powder coated; luminaire housing can be attached to mounting plate without tools by interlock; choice of adjustable / fixed symmetric or asymmetric radiation characteristic; variants with sym. radiation characteristic: precise due to high quality lens system; variants with asym. radiation characteristic: high-quality reflector with micro-faceted, aluminum-vaporised surface; COB (Chip on Board) technology for maximum efficiency (ADJUSTABLE and DOWNLIGHT); no multiple shadows; efficient LEDs with very good colour rendering; external converter for ceiling insertion, for through-wiring suitable

DE Quadratischer Halbeinbaustrahler aus Aluminium in 2 Größen; Lichteinsatz lackiert; Gehäuse pulverbeschichtet; Leuchtenkörper mittels Verriegelung werkzeuglos auf Montageplatte aufsetzbar; wahlweise einstellbar / starr symmetrische oder asymmetrische Abstrahlcharakteristik; sym. strahlende Varianten: präzise durch hochwertige Linsenoptik; asym. strahlende Varianten: hochwertiger Reflektor mit mikrofacettierter, aluminiumbedampfter Oberfläche; COB (Chip on Board) Technologie für höchste Effizienz (ADJUSTABLE und DOWNLIGHT); keine Mehrfachschatten; effiziente LEDs mit sehr guter Farbwiedergabe; externer Konverter für Deckeneinwurf, für Weiterverdrahtung geeignet

Quickinfo

2700 K, 3000 K, 4000 K
CRI ≥ 90, 2 SDCM
SASSO 60 up to 86 lm/W
SASSO 100 up to 119 lm/W
L80 @ 50 000 h
non DIM, DALI-2

Types

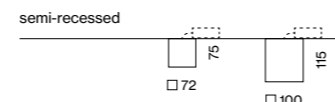

Housing colours



Inset colours



Light distributions

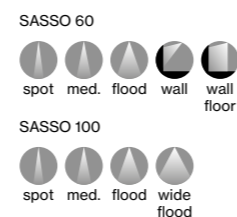

wallwasher and
ww floor inset

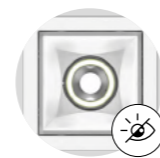

glare control
(UGR ≤ 16)



easy mounting;
no visible screws



CWD
1800–3000 K



CRI ≥ 95
2 SDCM

Order options

COLOUR TEMPERATURE	
2700 K	4
3000 K	5
4000 K	6

HOUSING COLOUR	
○ traffic white RAL 9016	7
● jet black RAL 9005	1

INSET COLOUR	
○ traffic white RAL 9016 (UGR ≤ 22)	7
● matt silver (UGR ≤ 19)	4
● jet black RAL 9005 (UGR ≤ 16)	1
● gold dust RAL 260-M (UGR ≤ 19)	9

BEAM ANGLE SASSO 60	
spot 15°	S
medium 21°	M
flood 42°	F

BEAM ANGLE SASSO 100	
spot 19°	S
medium 34°	M
flood 45°	F
wide flood 65°	W

Options on request

COLOUR RENDERING INDEX
CRI ≥ 95, 2 SDCM

COLOUR TEMPERATURE

CWD 1800–3000 K
not for WW & WWF version

CONTROL

Casambi

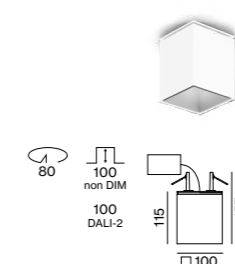
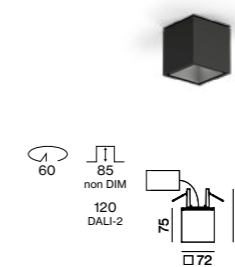

SASSO 60 square semi-recessed



DOWNLIGHT	INSET POWER	LUMINOUS FLUX	ORDER CODE
	10.7 W 36 Vf 300 mA	1100 lm	0 4 8 - 3 0 0 1 :: 1 ■ ■ ▲



WALLWASHER	INSET POWER	LUMINOUS FLUX	ORDER CODE
	8.2 W 27 Vf 300 mA	635 lm	0 4 8 - 3 6 0 1 :: 1 ■ ■ ▲

WALLWASHER/FLOOR

INSET POWER	LUMINOUS FLUX	ORDER CODE
8.2 W 27 Vf 300 mA	633 lm	0 4 8 - 3 6 0 1 :: 1 ■ ■ W

SASSO 100 square semi-recessed



ADJUSTABLE	INSET POWER	LUMINOUS FLUX	ORDER CODE
	17.2 W 36 Vf 500 mA	1890 lm*	0 4 8 - 3 3 0 1 :: 1 ■ ■ ▲

*reflector wide flood

Electrical accessories

POWER SUPPLY 220-240 V AC 50-60 Hz, PC II

TYPE	EFFICIENCY	L-WH (mm)	ORDER CODE
300 mA non DIM	η 85 %	85-40-22	0 0 2 - 9 0 7 7 1
300 mA DALI-2	η 88 %	143-43-30	0 0 2 - 9 0 7 6 2
500 mA non DIM	η 88 %	143-43-30	0 0 2 - 9 0 7 7 7
500 mA DALI-2	η 88 %	143-43-30	0 0 2 - 9 0 7 7 9

THROUGH WIRING CONNECTION BOX for SASSO 100

TYPE	L-WH (mm)	ORDER CODE
non DIM cable ø 4–12 mm	105-58-30	0 0 5 - 2 5 3 1 1 1 0
DALI cable ø 4–12 mm	105-58-30	0 0 5 - 2 5 5 1 1 1 0

DIN RAIL COMPONENTS

TYPE	W-H-D (mm)	ORDER CODE
POWER SUPPLY 220-240 V AC 96 W 48V DC constant voltage	90-90-60	0 0 5 - 6 5 2 0 2 1 0
LED DRIVER DALI-2 DT6 1–2 addr. 200–1050 mA settable const. current 2 × 42 W 48 V DC U _{OUT} 10–40 V	36-88-59	0 0 5 - 6 1 2 1 0 3 0

for more details and components see page 981

INSET POWER is the current consumption excluding any ballast
LUMINOUS FLUX value calculated for 3000 K, CRI ≥ 90, colour white, flood 2700 K -5%, 4000 K +5%

← back



SASSO 60/100 square

ceiling

EN Square ceiling mounted spotlight made of aluminium, available in 2 sizes; light inset lacquered; housing powder coated; luminaire housing can be attached to mounting plate without tools by interlock; choice of adjustable / fixed symmetric or asymmetric radiation characteristic; variants with sym. radiation characteristic: precise due to high quality lens system; variants with asym. radiation characteristic: high-quality reflector with micro-faceted, aluminum-vaporised surface; COB (Chip on Board) technology for maximum efficiency (ADJUSTABLE and DOWNLIGHT); no multiple shadows; efficient LEDs with very good colour rendering; luminaire for through wiring; converter integrated into spotlight head

DE Quadratischer Deckenanbaustrahler aus Aluminium in 2 Größen; Lichteinsatz lackiert; Gehäuse pulverbeschichtet; Leuchtenkörper mittels Verriegelung werkzeuglos auf Montageplatte aufsetzbar; wahlweise einstellbar / starr symmetrische oder asymmetrische Abstrahlcharakteristik; sym. strahlende Varianten: präzise durch hochwertige Linsenoptik; asym. strahlende Varianten: hochwertiger Reflektor mit mikrofacettierter, aluminiumbedampfter Oberfläche; COB (Chip on Board) Technologie für höchste Effizienz (ADJUSTABLE und DOWNLIGHT); keine Mehrfachschatten; effiziente LEDs mit sehr guter Farbwiedergabe; Leuchte für Weitverdrahtung; Konverter im Strahlerkopf integriert

Quickinfo

2700 K, 3000 K, 4000 K
CRI ≥ 90, 2 SDCM
SASSO 60 up to 94lm/W
SASSO 100 up to 101lm/W
L80 @ 50 000 h
non DIM, DALI-2

Types

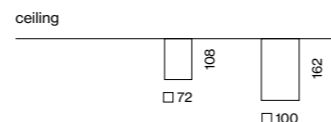

Housing colours



Inset colours



Light distributions

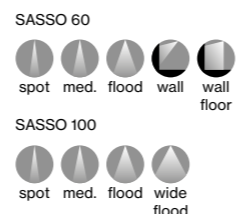

wallwasher and
ww floor inset

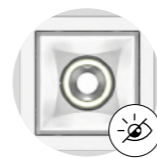

glare control
(UGR ≤ 16)

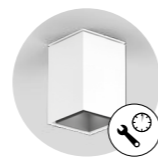

easy mounting;
no visible screws



CWD
1800–3000 K



CRI ≥ 95
2 SDCM

Order options

COLOUR TEMPERATURE	
2700 K	4
3000 K	5
4000 K	6

CONTROL	
non DIM	1
DALI-2	3

HOUSING COLOUR	
○ traffic white RAL 9016	7
● jet black RAL 9005	1

INSET COLOUR	
○ traffic white RAL 9016 (UGR ≤ 22)	7
● matt silver (UGR ≤ 19)	4
● jet black RAL 9005 (UGR ≤ 16)	1
● gold dust RAL 260-M (UGR ≤ 19)	9

BEAM ANGLE SASSO 60	
spot 15°	S
medium 21°	M
flood 42°	F

BEAM ANGLE SASSO 100	
spot 19°	S
medium 34°	M
flood 45°	F
wide flood 65°	W

Options on request

COLOUR RENDERING INDEX
CRI ≥ 95, 2 SDCM

COLOUR TEMPERATURE
CWD 1800–3000 K
not for WW & WWF version

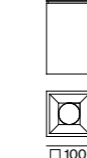

SASSO 60 square ceiling



DOWNLIGHT

SYSTEM POWER	COLOUR TEMP.	LUMINOUS FLUX	ORDER CODE
11.6 W	2700 K	857 lm	0 4 8 - 3 0 1 0 :: ◊ ◻ ◻ ▲
	3000 K	927 lm	
	4000 K	996 lm	



WALLWASHER

SYSTEM POWER	COLOUR TEMP.	LUMINOUS FLUX	ORDER CODE
11.4 W	2700 K	617 lm	0 4 8 - 3 6 1 0 :: ◊ ◻ ◻ ▲
	3000 K	617 lm	
	4000 K	726 lm	

WALLWASHER/FLOOR

SYSTEM POWER	COLOUR TEMP.	LUMINOUS FLUX	ORDER CODE
11.4 W	2700 K	633 lm	0 4 8 - 3 6 1 0 :: ◊ ◻ ◻ W
	3000 K	633 lm	
	4000 K	746 lm	

SASSO 100 square ceiling



ADJUSTABLE

SYSTEM POWER	COLOUR TEMP.	LUMINOUS FLUX	ORDER CODE
20.2 W	2700 K	1700 lm	0 4 8 - 3 3 1 0 :: ◊ ◻ ◻ ▲
	3000 K	1840 lm	
	4000 K	1980 lm	

LUMINOUS FLUX value calculated for
CRI ≥ 90, colour white, reflector flood

Relesys Office Copenhagen, DK –
by Lobo-Lab Architects
with lighting design by anker & co





SASSO 60/100 round

suspended

EN Cylindrical spotlight made of aluminium, available in 2 sizes; light inset lacquered; housing powder coated; pendant fitting with cable suspension; incl. feed (black or white); can be individually shortened; precise radiation characteristic due to high quality lens system; COB (Chip on Board) technology for maximum efficiency; no multiple shadows; efficient LEDs with very good colour rendering; canopy for through wiring; converter included in canopy

DE Zylindrischer Strahler aus Aluminium in 2 Größen; Lichteinsatz lackiert; Gehäuse pulverbeschichtet; abgependelt mit Seilabhangung; inkl. Einspeiseleitung (schwarz oder wei); beliebig kurzbar; prazise Abstrahlcharakteristik durch hochwertige Linsenoptik; COB (Chip on Board) Technologie fur hochste Effizienz; keine Mehrfachschatten; effiziente LEDs mit sehr guter Farbwiedergabe; Baldachin fur Weiterverdrahtung; Konverter im Baldachin enthalten

Quickinfo

2700 K, 3000 K, 4000 K
CRI ≥ 90, 2 SDCM
SASSO 60 up to 83 lm/W
SASSO 100 up to 98 lm/W
L80 @ 50 000 h
non DIM, DALI-2

Types

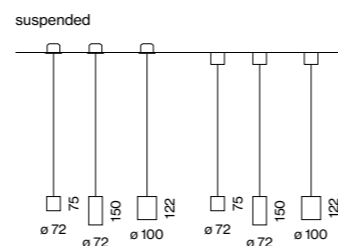

Housing colours



Inset colours



Light distributions

SASSO 60



SASSO 100



glare control
(UGR ≤ 16)



easy mounting;
no visible screws



CRI ≥ 95
2 SDCM

Order options

HOUSING HEIGHT	
75 mm	2
150 mm	7

COLOUR TEMPERATURE	
2700 K	4
3000 K	5
4000 K	6

CONTROL	
non DIM	1
DALI-2	3

HOUSING COLOUR	
○ traffic white RAL 9016	7
● jet black RAL 9005	1

INSET COLOUR	
○ traffic white RAL 9016 (UGR ≤ 22)	7
● matt silver (UGR ≤ 19)	4
● jet black RAL 9005 (UGR ≤ 16)	1
● gold dust RAL 260-M (UGR ≤ 19)	9

BEAM ANGLE	
SASSO 60	
spot 15°	S
medium 21°	M
flood 42°	F

BEAM ANGLE	
SASSO 100	
spot 19°	S
medium 34°	M
flood 45°	F
wide flood 65°	W

Options on request

COLOUR RENDERING INDEX
CRI ≥ 95, 2 SDCM

MOUNTING

recessed canopy

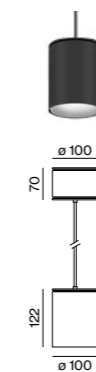
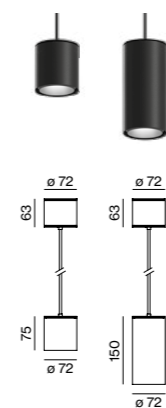

SASSO 60 round suspended



DOWNLIGHT

SYSTEM POWER	COLOUR TEMP.	LUMINOUS FLUX	ORDER CODE
11.6 W	2700 K	833 lm	0 4 8 - 3 1 L 0 :: ◀ ▶ ▢ ▲
	3000 K	901 lm	
	4000 K	968 lm	

SASSO 100 round suspended



DOWNLIGHT

SYSTEM POWER	COLOUR TEMP.	LUMINOUS FLUX	ORDER CODE
20.2 W	2700 K	1650 lm	0 4 8 - 3 4 2 0 :: ◀ ▶ ▢ ▲
	3000 K	1790 lm	
	4000 K	1920 lm	

LUMINOUS FLUX value calculated for
CRI ≥ 90, colour white, reflector wide flood

James Good Coiffeur Lounge
Flums, CH – by Daniel Huber Architektur GmbH



← back



SASSO 60 base

ceiling

EN Cylindrical or square spotlight made of aluminium; light inset lacquered; housing powder coated; light inset rotatable and tiltable (cylindrical versions); choice of single lamp or double lamps (cylindrical versions); surface mounted housing in aluminium incl. converter; mounting plate with pre-assembled converter unit can be pre-mounted; luminaire housing can be attached without tools by interlock; precise radiation characteristic due to high quality lens system; COB (Chip on Board) technology for maximum efficiency; no multiple shadows; efficient LEDs with very good colour rendering; luminaire for through wiring

DE Zylindrischer bzw. quadratischer Strahler aus Aluminium; Lichteinsatz lackiert; Gehäuse pulverbeschichtet; Lichteinsatz dreh- und schwenkbar (zylindr. Varianten); wahlweise einflammig oder zweiflammig (zylindr. Varianten); Anbaugeschäule aus Aluminium inkl. Konverter; Montageplatte mit vormontierter Konvertereinheit vorab montierbar; Leuchtenkörper mittels Verriegelung werkzeuglos aufsetzbar; präzise Abstrahlcharakteristik durch hochwertige Linsenoptik; COB (Chip on Board) Technologie für höchste Effizienz; keine Mehrfachschatten; effiziente LEDs mit sehr guter Farbwiedergabe; Leuchte für Weiterverdrahtung

Quickinfo

2700 K, 3000 K, 4000 K
CRI ≥ 90, 2 SDCM
SASSO round up to 90 lm/W
SASSO square up to 86 lm/W
L80 @ 50 000 h
non DIM, DALI-2

Types

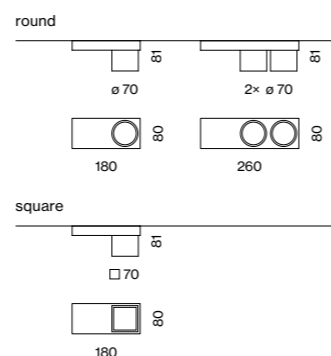

Housing colours



Inset colours



Light distributions



Order options

COLOUR TEMPERATURE	
2700 K	4
3000 K	5
4000 K	6

CONTROL	
non DIM	1
DALI-2	3

HOUSING COLOUR	
○ traffic white RAL 9016	7
● jet black RAL 9005	1

INSET COLOUR	
○ traffic white RAL 9016 (UGR ≤ 22)	7
● matt silver (UGR ≤ 19)	4
● jet black RAL 9005 (UGR ≤ 16)	1
● gold dust RAL 260-M (UGR ≤ 19)	9

BEAM ANGLE	
spot 15°	S
medium 21°	M
flood 42°	F

Options on request

COLOUR RENDERING INDEX	
CRI ≥ 95, 2 SDCM	

LIGHT DISTRIBUTION	
wallwasher	
wallwasher / floor	

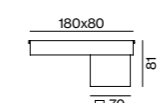
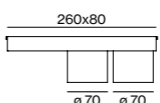
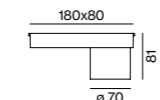

SASSO 60 base round

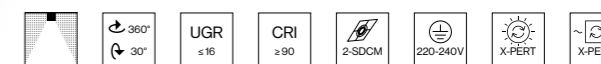

ADJUSTABLE 1 LAMP

SYSTEM POWER	COLOUR TEMP.	LUMINOUS FLUX	ORDER CODE
11.7 W	2700 K	816 lm	0 4 8 - 3 1 3 0 :: ◆ ▣ ▣ ▲
	3000 K	882 lm	
	4000 K	948 lm	

ADJUSTABLE 2 LAMPS

SYSTEM POWER	COLOUR TEMP.	LUMINOUS FLUX	ORDER CODE
21.6 W	2700 K	2 × 873 lm	0 4 8 - 3 1 4 0 :: ◆ ▣ ▣ ▲
	3000 K	2 × 921 lm	
	4000 K	2 × 977 lm	

SASSO 60 base square



DOWNLIGHT 1 LAMP

SYSTEM POWER	COLOUR TEMP.	LUMINOUS FLUX	ORDER CODE
11.7 W	2700 K	865 lm	0 4 8 - 3 0 3 0 :: ◆ ▣ ▣ ▲
	3000 K	936 lm	
	4000 K	1010 lm	

LUMINOUS FLUX value calculated for CRI ≥ 90, colour white, reflector flood



The Raum Bolzano, IT –
by bergundtal gmbh.



Quickinfo

2700 K, 3000 K, 4000 K
 CRI ≥ 90, 2 SDCM
 SASSO 60 up to 69 lm/W
 SASSO 100 up to 61 lm/W
 L80 @ 50 000 h
 non DIM, DALI-2

Types**Housing colours****Inset colours****Light distributions**

direct direct
indirect

Order options

COLOUR TEMPERATURE	
2700 K	4
3000 K	5
4000 K	6

CONTROL	
non DIM	1
DALI-2	3

HOUSING COLOUR	
○ traffic white RAL 9016	7
● jet black RAL 9005	1

INSET COLOUR	
○ traffic white RAL 9016 (UGR ≤ 22)	7
● matt silver (UGR ≤ 19)	4
● jet black RAL 9005 (UGR ≤ 16)	1
● gold dust RAL 260-M (UGR ≤ 19)	9

BEAM ANGLE

opal lens

Options on request

COLOUR RENDERING INDEX
 CRI ≥ 95, 2 SDCM

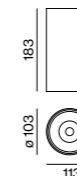
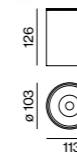
**SASSO 60 round wall****DIRECT**

SYSTEM POWER	COLOUR TEMP.	LUMINOUS FLUX	ORDER CODE
11.7 W	2700 K	647 lm	0 4 8 - 3 1 5 0 :: ◆ ▣ ■ ○
	3000 K	683 lm	
	4000 K	724 lm	

DIRECT / INDIRECT

SYSTEM POWER	COLOUR TEMP.	LUMINOUS FLUX	ORDER CODE
20.4 W	2700 K	2 × 643 lm	0 4 8 - 3 1 6 0 :: ◆ ▣ ■ ○
	3000 K	2 × 678 lm	
	4000 K	2 × 720 lm	

SASSO 100 round wall**DIRECT**

SYSTEM POWER	COLOUR TEMP.	LUMINOUS FLUX	ORDER CODE
20.4 W	2700 K	1130 lm	0 4 8 - 3 4 5 0 :: ◆ ▣ ■ ○
	3000 K	1180 lm	
	4000 K	1240 lm	

DIRECT / INDIRECT

SYSTEM POWER	COLOUR TEMP.	LUMINOUS FLUX	ORDER CODE
41 W	2700 K	2 × 1130 lm	0 4 8 - 3 4 6 0 :: ◆ ▣ ■ ○
	3000 K	2 × 1180 lm	
	4000 K	2 × 1240 lm	

SASSO 60/100 round

wall

^{EN} Cylindrical wall surface mounted luminaire made of aluminium, available in 2 sizes; light inset lacquered; housing powder coated; optionally symmetric direct or direct / indirect light distribution; homogeneous wall or ceiling illumination through uniform light distribution; precise radiation characteristic due to high quality lens system; installation of variant DIRECT optionally for floor or ceiling illumination; COB (Chip on Board) technology for maximum efficiency; no multiple shadows; efficient LEDs with very good colour rendering

^{DE} Zylindrische Wandanbauleuchte aus Aluminium in 2 Größen; Lichteinsatz lackiert; Gehäuse pulverbeschichtet; wahlweise symmetrisch direkte oder direkt/indirekte Abstrahlcharakteristik; homogene Wand- bzw. Deckenaufhellung durch gleichmäßige Lichtverteilung; präzise Abstrahlcharakteristik durch hochwertige Linsenoptik; Montage Variante DIRECT wahlweise zur Boden- oder Deckenaufhellung; COB (Chip on Board) Technologie für höchste Effizienz; keine Mehrfachschatten; effiziente LEDs mit sehr guter Farbwiedergabe



direct and direct /
indirect illumination



high quality
lens



easy
mounting



CRI ≥ 95
2 SDCM

LUMINOUS FLUX value calculated for
 CRI ≥ 90, colour white, lens opal

MAM Competence Center
Großhöflein, AT –
by INNOCAD Architektur ZT



The exquisite choice



SASSO PRO

EN The high-quality reflector ensures a particularly even light pattern and professional glare control. Its exclusive design and high-quality appearance make SASSO the ideal spotlight on the shop floor. The spotlights can be rotated through 360° and can also be swivelled by up to 35° around the horizontal central axis. This means light can be flexibly redirected even after installation, depending on the shop concept. Thanks to its replaceable light insets, the spotlight can be installed quickly and without any tools using a ball-catch system. SASSO is available in various sizes, colours, and with optical accessories. For the light colours, you can choose between 2700K, 3000K, 4000K, or the dynamic gradient Colour Warm Dimming and Tunable White versions.

DE Der hochwertige Reflektor sorgt für ein besonders gleichmäßiges Lichtbild und professionelle Entblendung. Sein exklusives Design und hochwertiges Erscheinungsbild machen SASSO zum idealen Strahler im Shopbereich. Die Spots können um 360° gedreht werden und sind zusätzlich um bis zu 35° um die horizontale Mittelachse schwenkbar. Dadurch kann Licht auch nach der Installation flexibel gelenkt werden – je nach Shop-Konzept. Durch seine tauschbaren Lichteinsätze kann der Spot schnell und werkzeuglos mittels Kugelschnappsystem eingebaut werden. SASSO ist in verschiedenen Größen, Farben und mit optischen Zubehör erhältlich. Bei den Lichtfarben haben Sie die Auswahl zwischen 2700K, 3000K, 4000K oder den dynamischen Verlaufsvarianten Colour Warm Dimming und Tunable White.

Types



80

100

Mountings

trimless
recessedwith trim
recessed

Light distribution



spotlight

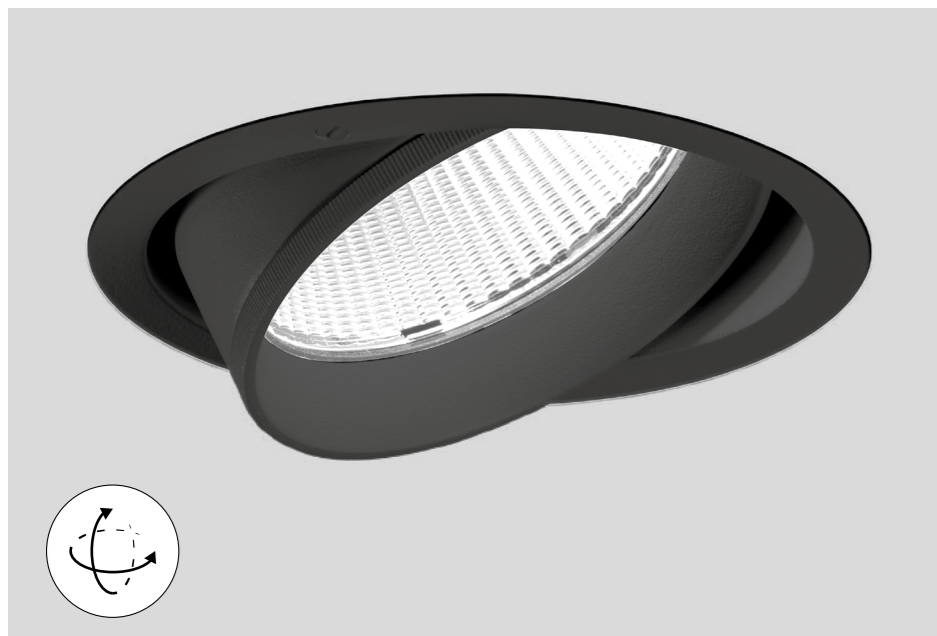

Precise light adjustment

EN In addition to the 360° rotatability of all SASSO Round 80/100 variants, the adjustable version can be swivelled up to 35° around the horizontal central axis. This enables light to be directed precisely where it is needed.

DE Zusätzlich zur 360°-Drehbarkeit aller SASSO Round 80/100 Varianten kann die Adjustable-Ausführung bis zu 35° um die horizontale Mittelachse geschwenkt werden. Das ermöglicht eine noch exaktere Lenkung des Lichts dorthin, wo es gebraucht wird.



Reflector inset

EN The high-quality reflector with spherical faceted optics ensures a uniform light pattern with significant glare control. SASSO is an attractive lighting solution in the premium shop area, thanks to its high-quality appearance.

DE Der hochwertige Reflektor mit sphärischer Facettenoptik sorgt für ein gleichmäßiges Lichtbild bei zusätzlich guter Entblendung. Dank seines hochwertigen Erscheinungsbildes ist SASSO auch eine attraktive Lichtlösung im Premium-Shopbereich.

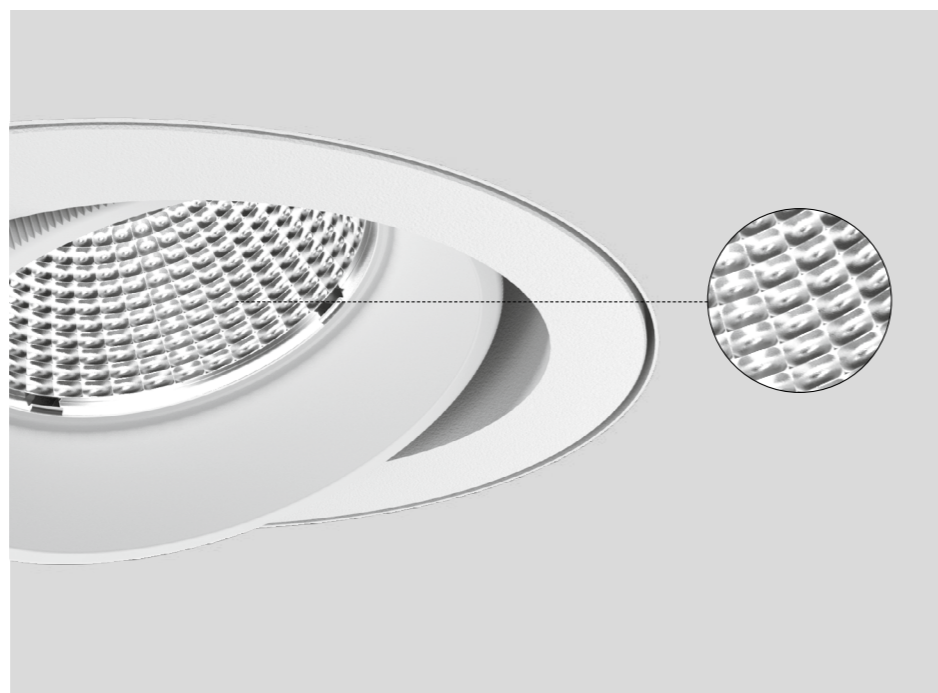

Optical accessories

EN Use a wide range of optical accessories to adapt spotlights for special applications. The optical light accessories can be attached or removed in one easy step and provide glare-free light at any point.

DE Nutzen Sie vielfältiges optisches Zubehör, um Strahler für spezielle Anwendungsbereiche anzupassen. Die optischen Licht-Accessoires lassen sich mit nur einem Handgriff aufsetzen oder abnehmen und sorgen an jeder Stelle für blendfreies Licht.

CWD – Colour Warm Dimming

EN Warm light quality with reduced illuminance. Colour Warm Dimming reduces the light intensity while continuously changing the colour temperature between 3000 K and 1800 K. The function supports, for example, the change between cosy restaurant lighting during the day and a relaxing lighting mood in the evening.

DE Warme Lichtqualität bei reduzierter Beleuchtungsstärke: Colour Warm Dimming senkt zugleich die Lichtintensität und wechselt die Farbtemperatur stufenlos zwischen 3000 K und 1800 K. Die Funktion unterstützt etwa den Wechsel zwischen gemütlicher Restaurant-Beleuchtung tagsüber und einer entspannenden Lichtstimmung am Abend.



TW – Tunable White

EN Changes in the colour of light have a substantial effect on our mood. Tunable White allows the colour temperature to be continuously adjusted from 2700 K (warm light) to 6500 K (cool light) to dynamically adapt the lighting to the time of day or ambient brightness.

DE Veränderungen in der Lichtfarbe haben eine starke Wirkung auf unsere Stimmung. Tunable White ermöglicht die stufenlose Verschiebung der Farbtemperatur von 2700 K (warmes Licht) bis 6500 K (kühles Licht), um die Beleuchtung dynamisch an Uhrzeit oder Umgebungslicht anzupassen.

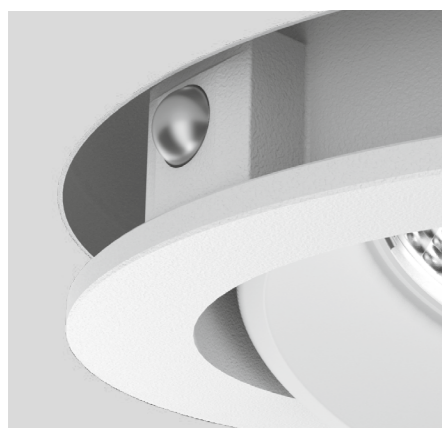
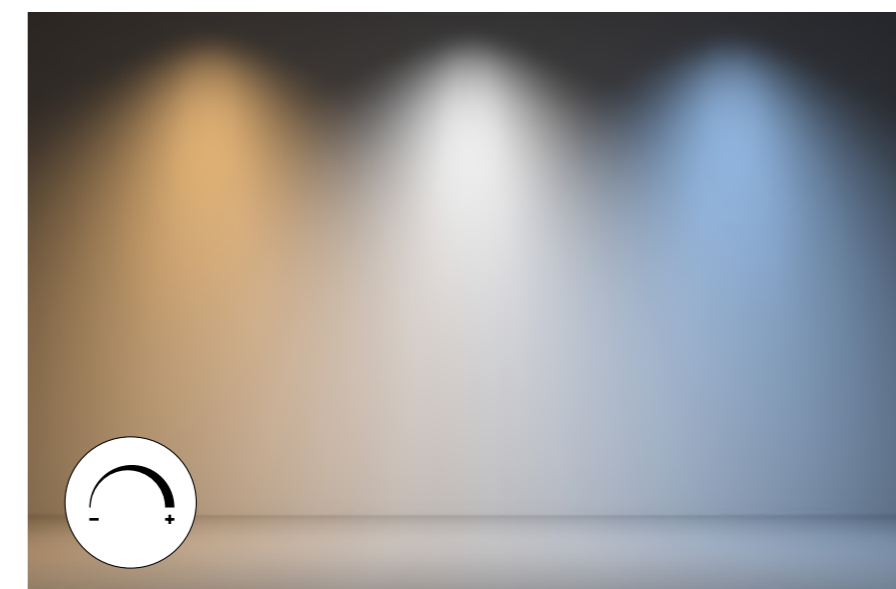

Ball catch system

EN SASSO spots are easy to replace. The assembly is quick and entirely without tools, thanks to a ball catch system. The lighting thus always adapts flexibly to new requirements and circumstances.

DE SASSO Spots sind einfach austauschbar: Die Montage erfolgt schnell und völlig ohne Werkzeug durch ein Kugelschnappsystem. So passt sich die Beleuchtung stets flexibel den neuen Anforderungen und Gegebenheiten an.

← back

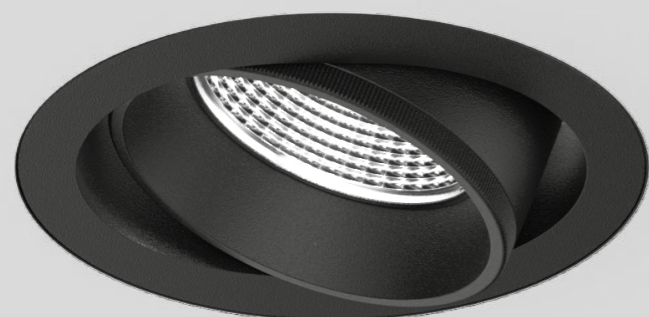

SASSO PRO 80 flush/offset

recessed

EN Round recessed spotlight in die-cast aluminium; installation without tools in mounting set with ball catch system; surface powder coated; installation possible in different housings; light inset rotatable and tiltable; optionally with recessed lighting level; optical attachments as accessories; with optional high-quality lens system with precise radiation characteristic; and high-quality reflector with spherical facet effect design, precise radiation characteristics with different beam angles; installed and exchanged without tools; COB (Chip on Board) technology or high power LEDs for maximum efficiency; no multiple shadows; efficient LEDs with very good colour rendering

DE Runder Einbaustrahler aus Aluminiumdruckguss; werkzeuglose Montage im Montageset durch Kugelschnappsystem; Oberfläche pulverbeschichtet; Einbau in unterschiedlichen Gehäusen möglich; Licht-einsatz dreh- und schwenkbar; optional mit zurückversetzter Leuchtenebene; optische Aufsätze als Zubehör; wahlweise mit hochwertiger Linsenoptik mit präziser Abstrahlcharakteristik; bzw. hochwertiger Reflektor mit sphärischer Facettenoptik, präzise Abstrahlcharakteristik mit verschiedenen Ausstrahlwinkeln; werkzeuglos einsetz- bzw. austauschbar; mit COB (Chip on Board) Technologie bzw. High-Power-LEDs für höchste Effizienz; keine Mehrfachschatten; effiziente LEDs mit sehr guter Farbwiedergabe

Quickinfo

2700 K, 3000 K, 4000 K, CWD
 CRI ≥ 90, 3 SDCM
 up to 93 lm/W
 L90 @ 50 000 h
 non DIM, DALI-2

Types

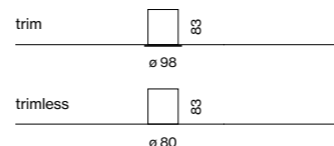

Colours



Light distributions



Order options

COLOUR TEMPERATURE	
2700 K	4
3000 K	5
4000 K	6
CWD 1800–2700 K	

CONTROL	
non DIM	1
DALI-2	3

MATERIAL COLOUR	
○ traffic white RAL 9016	7
● jet black RAL 9005	8

LENS	
super spot 6°	

BEAM ANGLE	
medium 27°	M
flood 37°	F

Options on request

MOUNTING SET	
acoustic soft ceilings	



DiiA® standards
251, 252, 253

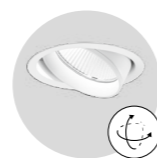

rotatable 360°
tiltable 35°

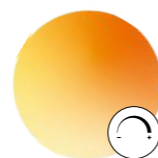

CWD
1800–2700 K

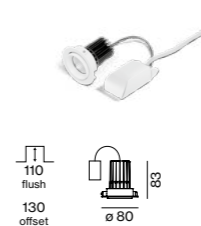

SASSO PRO 80



SPOTLIGHT ADJUSTABLE

SYSTEM POWER	COLOUR TEMP.	LUMINOUS FLUX	ORDER CODE
7.7 W	2700 K	353 lm	0 4 8 - 2 3 1 0 :: 1 ▢ V
super spot 6°	3000 K	379 lm	0 4 8 - 2 3 1 0 :: 1 ▢ ▲
	4000 K	408 lm	
8.3 W	2700 K	728 lm	0 4 8 - 2 3 1 2 :: ▢ ▢ ▲
	3000 K	765 lm	
	4000 K	773 lm	
12.2 W	2700 K	1020 lm	0 4 8 - 2 3 1 2 :: ▢ ▢ ▲
	3000 K	1060 lm	
	4000 K	1130 lm	

SYSTEM POWER	LUMINOUS FLUX	ORDER CODE
6.5 W CWD 1800–2700 K	378 lm	0 4 8 - 2 3 1 0 E 3 ▢ M

Mounting accessories

TRIMLESS MOUNTING SET

for installation in plasterboard ceilings 12.5/15/25 mm

TYPE	ORDER CODE
flush	0 5 2 - 1 9 2 1 3 2 7
offset 17 mm	0 5 2 - 1 9 3 1 3 2 ▢

ROUND MOUNTING SET WITH TRIM

for intermediate ceilings 5–25 mm

TYPE	ORDER CODE
flush	0 5 2 - 1 9 2 2 3 2 ▢
offset 17 mm	0 5 2 - 1 9 3 2 3 2 ▢

SQUARE MOUNTING SET WITH TRIM

for intermediate ceilings 5–25 mm

TYPE	ORDER CODE
flush	0 5 2 - 1 9 4 2 3 1 ▢
offset 17 mm	0 5 2 - 1 9 5 2 3 1 ▢

CONCRETE MOUNTING HOUSING

TYPE	L-W-H (mm)	ORDER CODE
exposed concrete ceilings*	229-227-160	0 6 0 - 0 0 0 8 0
primed concrete ceilings**	ø240-400-130	0 5 2 - 1 9 1 4 3 2 0

*only for flush mounting **order mounting set separately

Optical accessories

TYPE	ORDER CODE
honeycomb louver	0 4 8 - 2 0 9 1 3 1 ▢
linear prismatic lens	0 4 8 - 2 0 9 2 3 1 ▢
snoot	0 4 8 - 2 0 9 1 1 1 ▢
snoot with honeycomb louver	0 4 8 - 2 0 9 1 2 1 ▢

use only 1 optical accessory

Electrical accessories

THROUGH WIRING CONNECTION BOX

TYPE	L-W-H (mm)	ORDER CODE
non DIM cable ø 4–12 mm	105-58-30	0 0 5 - 2 5 3 1 1 1 0
DALI cable ø 4–12 mm	105-58-30	0 0 5 - 2 5 5 1 1 1 0

LUMINOUS FLUX value calculated for CRI ≥ 90, colour white, reflector flood, flush mounting

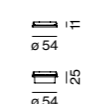
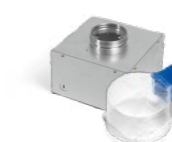
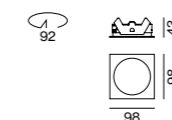
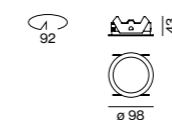
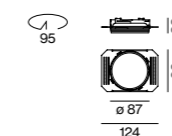

← back

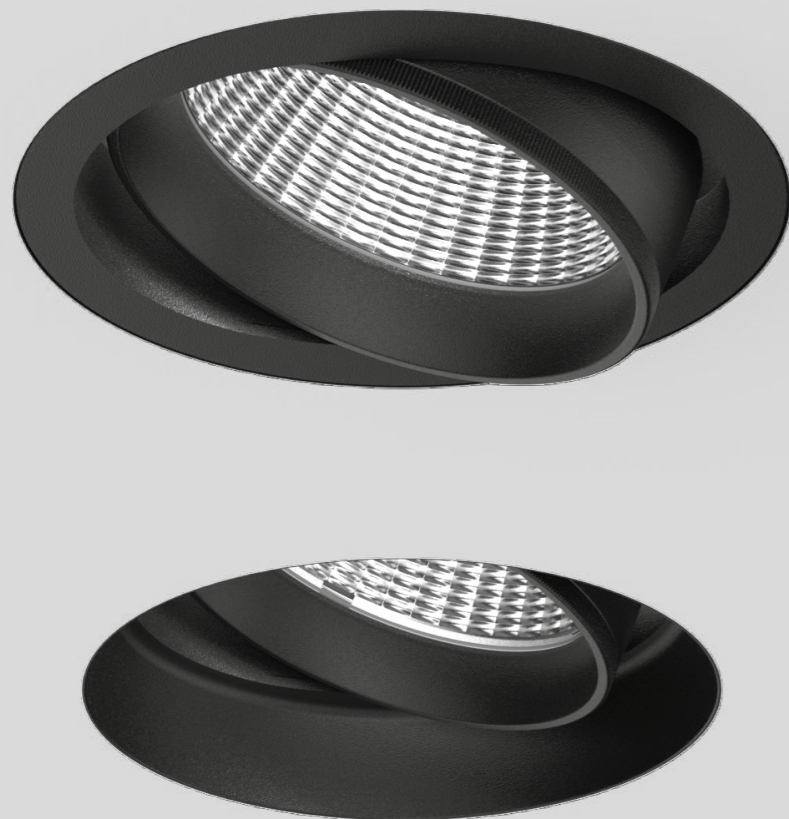

SASSO PRO 100 flush/offset

recessed

EN Round recessed spotlight in die-cast aluminium; installation without tools in mounting set with ball catch system; surface powder coated; installation possible in different housings; light inset rotatable and tiltable; optionally with recessed lighting level; optical attachments as accessories; high-quality reflector with spherical facet effect design, precise radiation characteristics with different beam angles; installed and exchanged without tools; COB (Chip on Board) technology for maximum efficiency; no multiple shadows; efficient LEDs with very good colour rendering

DE Runder Einbaustrahler aus Aluminiumdruckguss; werkzeuglose Montage im Montageset durch Kugelschnappsystem; Oberfläche pulverbeschichtet; Einbau in unterschiedlichen Gehäusen möglich; Licht-einsatz dreh- und schwenkbar; optional mit zurückversetzter Leuchtenebene; optische Aufsätze als Zubehör; hochwertiger Reflektor mit sphärischer Facettenoptik, präzise Abstrahlcharakteristik mit verschiedenen Ausstrahlwinkeln; werkzeuglos einsetz- bzw. austauschbar; COB (Chip on Board) Technologie für höchste Effizienz; keine Bildung von Mehrfachschatten; effiziente LEDs mit sehr guter Farbwiedergabe

Quickinfo

2700 K, 3000 K, 4000 K, CWD, TW
 CRI ≥ 90, 3 SDCM
 up to 104 lm/W
 L80 @ 50 000 h
 non DIM, DALI-2

Types

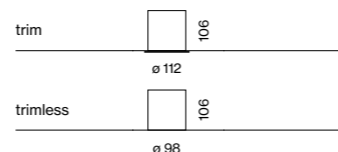

Colours



Light distributions



Order options

COLOUR TEMPERATURE	
2700 K	4
3000 K	5
4000 K	6
CWD 2000–3000 K	
TW 1800–3000 K	
TW 2700–6500 K	

CONTROL	
non DIM	1
DALI-2	3

MATERIAL COLOUR	
○ traffic white RAL 9016	7
● jet black RAL 9005	8

REFLECTOR	
spot 18° (not for HO version)	S
medium 24°	M
flood 36°	F
wide flood 55° (not for HO vers.)	W

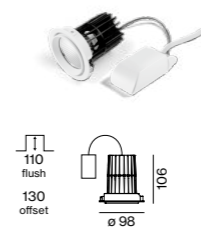

SASSO PRO 100



SPOTLIGHT ADJUSTABLE

SYSTEM POWER	COLOUR TEMP.	LUMINOUS FLUX	ORDER CODE
14.5 W	2700 K	1350 lm	0 4 8 - 2 4 1 0
	3000 K	1420 lm	
	4000 K	1490 lm	
26.5 W	2700 K	2160 lm	0 4 8 - 2 4 1 2
	3000 K	2260 lm	
	4000 K	2380 lm	
27 W HO	2700 K	2580 lm	0 4 8 - 2 4 1 3
	3000 K	2810 lm	
	4000 K	2840 lm	

SYSTEM POWER	LUMINOUS FLUX	ORDER CODE
14.7 W CWD 2000–3000 K	1030 lm	0 4 8 - 2 4 1 1 E 3
28.2 W TW 1800–3000 K	2020 lm	0 4 8 - 2 4 1 2 L 3
28.2 W TW 2700–6500 K	2170 lm	0 4 8 - 2 4 1 2 D 3

Mounting accessories

TRIMLESS MOUNTING SET

for installation in plasterboard ceilings 12.5/15/25 mm

TYPE	ORDER CODE
flush	0 5 2 - 1 9 2 1 4 4 7
offset 17 mm	0 5 2 - 1 9 3 1 4 4

ROUND MOUNTING SET WITH TRIM

for intermediate ceilings 5–25 mm

TYPE	ORDER CODE
flush	0 5 2 - 1 9 2 2 4 4
offset 17 mm	0 5 2 - 1 9 3 2 4 4

SQUARE MOUNTING SET WITH TRIM

for intermediate ceilings 5–25 mm

TYPE	ORDER CODE
flush	0 5 2 - 1 9 4 2 4 1
offset 17 mm	0 5 2 - 1 9 5 2 4 1

CONCRETE MOUNTING HOUSING

for <15 W version

TYPE	L·W·H (mm)	ORDER CODE
exposed concrete ceilings*	229·227·160	0 5 2 - 1 9 1 3 4 1 0
primed concrete ceilings**	ø240·400·130	0 5 2 - 1 9 1 4 4 2 0

*only for flush mounting **order mounting set separately

Optical accessories

TYPE	ORDER CODE
honeycomb louver	0 4 8 - 2 1 9 1 3 1
linear prismatic lens	0 4 8 - 2 1 9 2 3 1
snoot	0 4 8 - 2 1 9 1 1 1
snoot with honeycomb louver	0 4 8 - 2 1 9 1 2 1

use only 1 optical accessory

Electrical accessories

THROUGH WIRING CONNECTION BOX

TYPE	L·W·H (mm)	ORDER CODE
non DIM cable ø 4–12 mm	105·58·30	0 0 5 - 2 5 3 1 1 1 0
DALI cable ø 4–12 mm	105·58·30	0 0 5 - 2 5 5 1 1 1 0

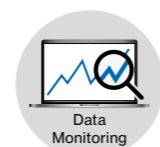

DiiA® standards
251, 252, 253

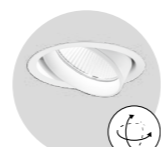

rotatable 360°
tiltable 35°



CWD
2000–3000 K

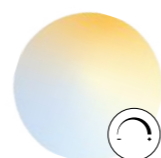

TW 1800–3000 K &
2700–6500 K

LUMINOUS FLUX value calculated for CRI ≥ 90, colour white, reflector flood, flush mounting

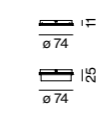
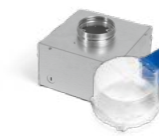
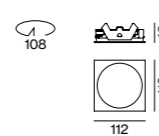
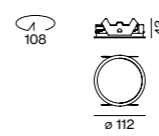
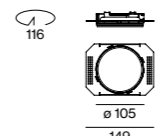

Oberpollinger | The KaDeWe Group
Munich, DE – by Licht Kunst Licht AG
including lighting design



Oberpollinger | The KaDeWe Group
Munich, DE – by Licht Kunst Licht AG
including lighting design



Presence as desired



MOVE IN

EN This luminaire's trump card is mobility. MOVE IN's appearance can be easily adapted without tools at any time because the spots are height-adjustable. New and exciting ceiling pictures are created by combining round or square with flush or protruding spots. The spots are optimally glare-free thanks to the recessed light point plane. MOVE IN flex's spotlight head can be rotated 360° and swivelled 90°. All spots are characterised by an excellent colour rendering value (CRI ≥ 90) and high-quality reflector. The light colours 2700K and 3000K create an atmospheric lighting effect.

DE Beweglichkeit ist Trumpf bei dieser Leuchtenserie. Mit MOVE IN ist das Erscheinungsbild jederzeit anpassbar, denn die Spots sind höhenverstellbar – einfach und ohne Werkzeug. Durch die Kombination aus runden und eckigen, deckenbündigen bzw. hervorragenden Spots entstehen immer neue, spannende Deckenbilder. Dank der zurückversetzten Lichtpunktebene sind die Spots optimal entblendet. Der Strahlerkopf von MOVE IN flex ist 360° dreh- und 90° schwenkbar, zusätzlich zeichnen sich alle Spots durch einen sehr guten Farbwiedergabewert (CRI ≥ 90) und einen hochwertigen Reflektor aus. Die Lichtfarben 2700K und 3000K sorgen für eine atmosphärische Lichtwirkung.

Types

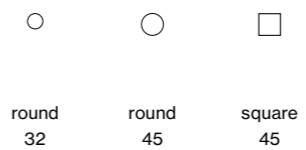

Mounting

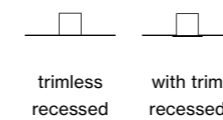

Light distributions

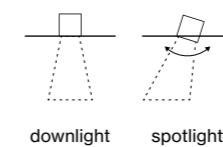

Variety

EN MOVE IN not only provides light, but also designs the ceiling. Round, angular, flush-mounted, and surface-mounted spots can be combined individually and always form new, exciting ceiling arrangements.

DE MOVE IN gibt nicht nur Licht, sondern gestaltet die Decke. Runde, eckige, deckenbündige und aufbauende Spots lassen sich individuell kombinieren und formen stets neue, spannende Deckenbilder.

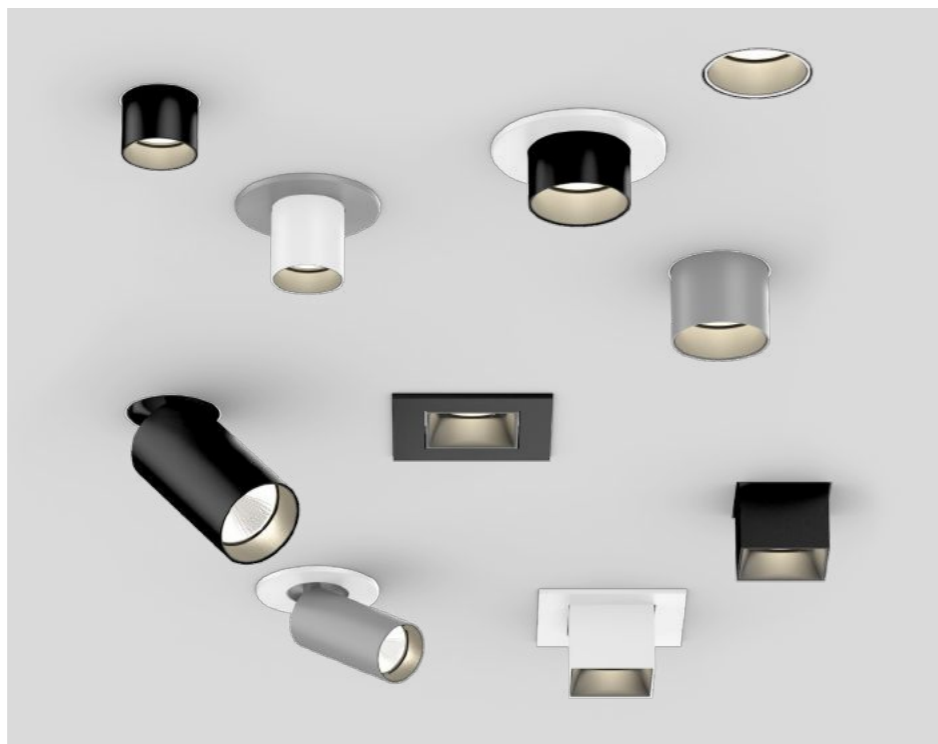

Light distribution

EN Thanks to different beam angles, MOVE IN is suitable for different areas of application: from narrow-beam spot for precise and targeted lighting, to medium and flood for accentuated basic brightness.

DE Dank verschiedener Ausstrahlwinkel ist MOVE IN für unterschiedliche Einsatzbereiche geeignet: vom eng ausstrahlenden Spot für präzise und zielgerichtete Beleuchtung, bis hin zu Medium und Flood für eine akzentuierte Grundhelligkeit.

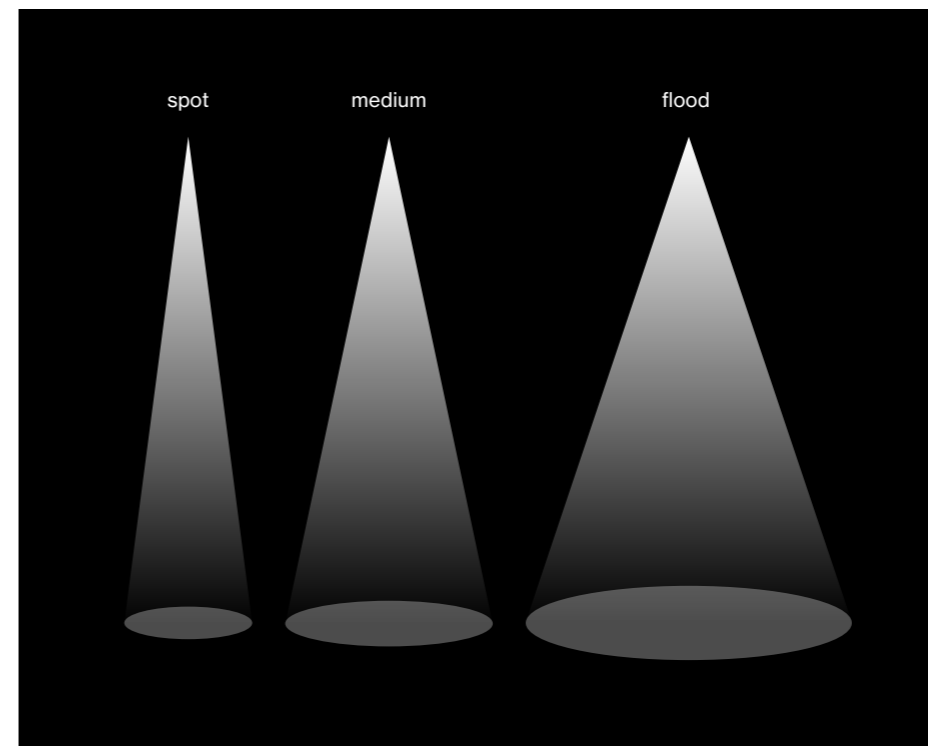

Glare control & colour rendering

EN Thanks to the recessed light spot level, MOVE IN spots provide optimum glare control. As the high-quality reflector optics have very good colour rendering values (CRI ≥ 90), objects are rendered almost true to colour.

DE Dank der zurückversetzten Lichtpunktebene sind MOVE IN Spots optimal entblendet. Da der hochwertige Reflektor über sehr gute Farbwiedergabewerte (CRI ≥ 90) verfügt, werden Objekte nahezu farbecht wiedergegeben.



Precise light adjustment

EN MOVE IN flex offers the greatest possible flexibility. The spotlight can not only be rotated 360°, but also swivelled 90°. This allows the light to be directed exactly where it is needed.

DE MOVE IN flex bietet größtmögliche Flexibilität. Der Strahler kann nicht nur um 360° gedreht, sondern auch um 90° geschwenkt werden. Das ermöglicht die exakte Lenkung des Lichts genau dorthin, wo es benötigt wird.

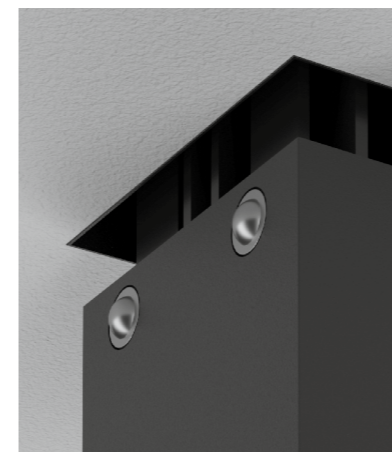

Ball catch system

EN Mounting and replacing MOVE IN spots is very easy. The spots are fixed in the system by a ball catch system. This in turn can be installed in three different positions – for flexible adaptation of the lighting to changing requirements and conditions.

DE Montage und Tausch von MOVE IN Spots sind denkbar einfach. Durch ein Kugelschnappsystem werden die Spots im System fixiert. Dieses wiederum lässt sich in drei verschiedenen Positionen installieren. Für eine flexible Anpassung der Beleuchtung an wechselnde Anforderungen und Konditionen.

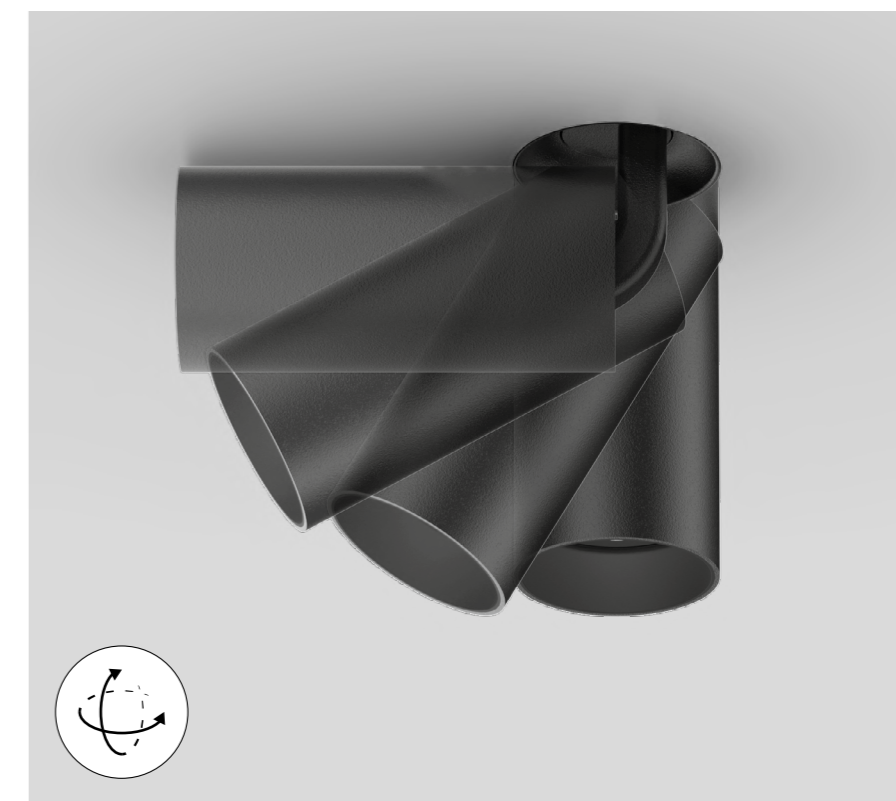

← back



MOVE IN round

recessed

Round spotlight element in aluminium, available in 2 sizes; powder coated; installation without tools in mounting set (trimless or with trim) with ball catch system; special mounting tool for easy installation of the trimless housing available as an accessory; spotlight element height adjustable without tools: flush with the ceiling, or extended 25 mm or 35 mm; COB (Chip on Board) technology for maximum efficiency; no multiple shadows; energy-efficient LEDs with very good colour rendering; high-quality, aluminium, vapour deposition coated reflector with faceted design; precise radiation characteristic; good glare reduction due to recessed light point plane; optical attachments as accessories

Rundes Strahlerelement aus Aluminium in 2 Größen; pulverbeschichtet; werkzeuglose Montage im Montageset (randlos oder mit umlaufendem Rand) durch Kugelschnappsystem; spezielles Montagewerkzeug zur einfachen Installation des randlosen Gehäuses als Zubehör erhältlich; Strahlerelement werkzeuglos höhenverstellbar: deckenbündig, 25 mm oder 35 mm herausragend; COB (Chip on Board) Technologie für höchste Effizienz; keine Mehrfachschattenbildung; energieeffiziente LEDs mit sehr guter Farbwiedergabe; hochwertiger, aluminiumbedampfter Reflektor mit Facettenoptik; präzise Abstrahlcharakteristik; gute Entblendung durch zurückversetzte Lichtpunktebene; optische Aufsätze als Zubehör

Quickinfo

2700 K, 3000 K
 CRI ≥ 90, 3 SDCM
 MOVE IN 32 up to 86 lm/W
 MOVE IN 45 up to 95 lm/W
 L80 @ 50 000 h
 non DIM, DALI-2

Types

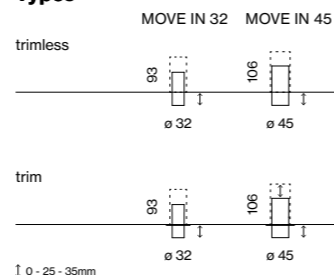

Inset colours



Housing colours



Light distributions

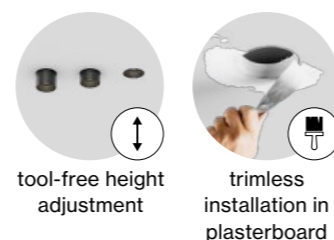

Order options

COLOUR TEMPERATURE	
2700 K	4
3000 K	5

INSET COLOUR	
○ traffic white RAL 9016	7
● jet black RAL 9005	8

HOUSING COLOUR	
○ traffic white RAL 9016	7
● silver-grey	G
● jet black RAL 9005	8

BEAM ANGLE	
MOVE IN 32 / 45	▲
spot 18° / 14°	S
medium 23° / 24°	M
flood 37° / 39°	F

Options on request

MOUNTING HOUSING	
special colours	

POWER SUPPLY	
DIM 1-10V	

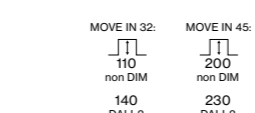
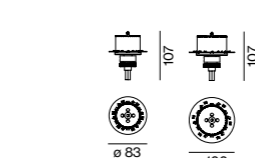
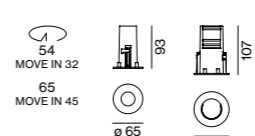
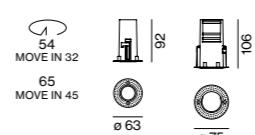
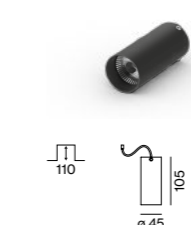
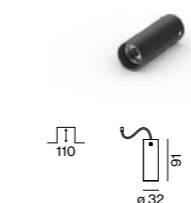

MOVE IN 32 round



SPOTLIGHT incl. connection cable 600 mm		
INSET POWER	LUMINOUS FLUX	ORDER CODE
8.8 W 36 Vf 250 mA	755 lm	063-81111

MOVE IN 45 round



SPOTLIGHT incl. connection cable 600 mm		
INSET POWER	LUMINOUS FLUX	ORDER CODE
12.8 W 37 Vf 350 mA	spot 1010 lm	063-81212
13.5 W 36 Vf 400 mA	1280 lm	063-81212

Mounting accessories

MOUNTING HOUSING TRIMLESS
 for installation in plasterboard ceilings 9-25 mm

TYPE	Ø-H (mm)	ORDER CODE
MOVE IN 32	63-93	063-8811117
MOVE IN 45	75-106	063-8812117

MOUNTING HOUSING WITH TRIM
 for installation in ceilings from 2-25 mm

TYPE	Ø-H (mm)	ORDER CODE
MOVE IN 32	65-93	063-8821117
MOVE IN 45	77-107	063-8822117

SPECIAL MOUNTING TOOL

TYPE	Ø-H (mm)	ORDER CODE
MOVE IN 32	83-9	063-8911110
MOVE IN 45	100-9	063-8912110

necessary to install mounting housing trimless

Electrical accessories

POWER SUPPLY 220-240 V AC, 50-60 Hz, PC II

TYPE	EFFICIENCY	L-W-H (mm)	ORDER CODE
250 mA non DIM	η 80 %	65-39-20	002-90742
250 mA DALI-2	η 82 %	147-33-23	002-90743
350 mA non DIM	η 85 %	180-30-21	002-90722
350 mA DALI-2	η 83 %	210-30-21	002-90723
400 mA non DIM	η 88 %	180-30-21	002-90724
400 mA DALI-2	η 84 %	210-30-21	002-90725

MOVE IN 32 trimless revision opening required

DIN RAIL COMPONENTS

TYPE	W-H-D (mm)	ORDER CODE
POWER SUPPLY 220-240 V AC	90-90-60	005-6520210
96 W 48 V DC constant voltage		
LED DRIVER DALI-2 DT6 1-2 addr.	36-88-59	005-6121030
200-1050 mA settable const. current		
2 × 42 W 48 V DC U _{OUT} 10-40 V		

for more details and components see page Seite 981

Optical accessories

HONEYCOMB LOUVER

TYPE	Ø-H (mm)	ORDER CODE
MOVE IN 32	30-3	007-1965168
MOVE IN 45	42-3	007-1965188

INSET POWER is the current consumption excluding any ballast
 LUMINOUS FLUX value calculated for 3000 K, CRI ≥ 90, colour white, reflector flood 2700 K -6%

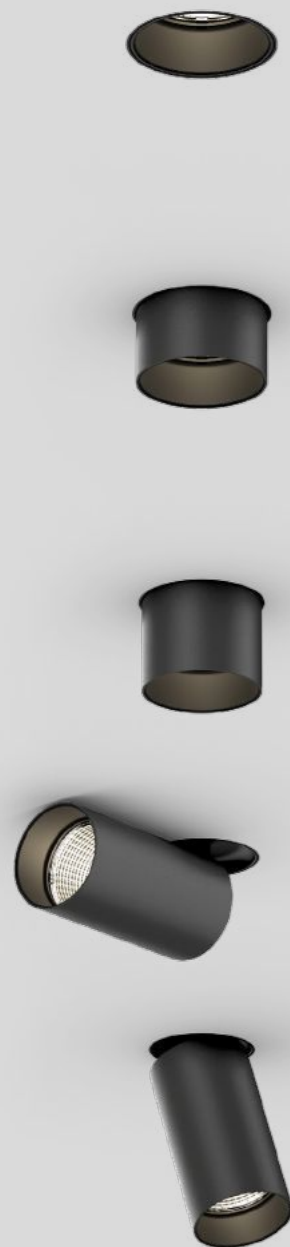
[← back](#)

MOVE IN flex

recessed

Round spotlight element in aluminium, available in 2 sizes; powder coated; installation without tools in mounting set (trimless or with trim) with ball catch system; special mounting tool for easy installation of the trimless housing available as an accessory; spotlight element height adjustable without tools: flush with the ceiling, or extended 25 mm or 35 mm; spotlight head rotates 360° and tilts 90°; COB (Chip on Board) technology for maximum efficiency; no multiple shadows; energy-efficient LEDs with very good colour rendering; high-quality, aluminium, vapour deposition coated reflector with faceted design; precise radiation characteristic; good glare reduction due to recessed light point plane; optical attachments as accessories

Rundes Strahlerelement aus Aluminium in 2 Größen; pulverbeschichtet; werkzeuglose Montage im Montageset (randlos oder mit umlaufendem Rand) durch Kugelschnappsystem; spezielles Montagewerkzeug zur einfachen Installation des randlosen Gehäuses als Zubehör erhältlich; Strahlerelement werkzeuglos höhenverstellbar: deckenbündig, 25 mm oder 35 mm herausragend; Strahlerkopf 360° dreh- und 90° schwenkbar; COB (Chip on Board) Technologie für höchste Effizienz; keine Mehrfachschattenbildung; energieeffiziente LEDs mit sehr guter Farbwiedergabe; hochwertiger, aluminiumbedampfter Reflektor mit Facettenoptik; präzise Abstrahlcharakteristik; gute Entblendung durch zurückversetzte Lichtpunktebene; optische Aufsätze als Zubehör

Quickinfo

2700 K, 3000 K
CRI ≥ 90, 3 SDCM
MOVE IN 32 up to 86 lm/W
MOVE IN 45 up to 95 lm/W
L80 @ 50 000 h
non DIM, DALI-2

Types

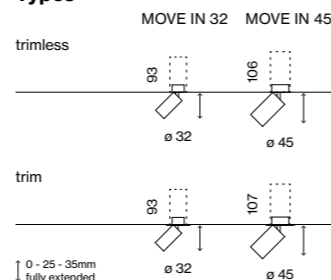

Inset colours



Housing colours



Light distributions



tool-free height adjustment, rotatable & tiltable

trimless installation in plasterboard

Order options

COLOUR TEMPERATURE	
2700 K	4
3000 K	5

INSET COLOUR	
○ traffic white RAL 9016	7
● jet black RAL 9005	8

HOUSING COLOUR	
○ traffic white RAL 9016	7
● silver-grey	G
● jet black RAL 9005	8

BEAM ANGLE	
MOVE IN 32 / 45	▲
spot 18° / 14°	S
medium 23° / 24°	M
flood 37° / 39°	F

Options on request

MOUNTING HOUSING	
special colours	

POWER SUPPLY	
DIM 1-10V	

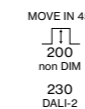
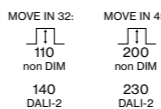
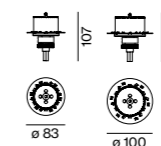
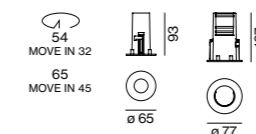
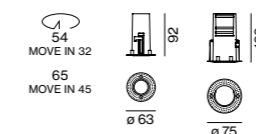

MOVE IN 32 flex



SPOTLIGHT incl. connection cable 600 mm

INSET POWER	LUMINOUS FLUX	ORDER CODE
8.8 W 36 Vf 250 mA	755 lm	063-82111

MOVE IN 45 flex



SPOTLIGHT incl. connection cable 600 mm

INSET POWER	LUMINOUS FLUX	ORDER CODE
12.8 W 37 Vf 350 mA	spot 1010 lm	063-82211
13.5 W 36 Vf 400 mA	1280 lm	063-82211

Mounting accessories

MOUNTING HOUSING TRIMLESS
for installation in plasterboard ceilings 9-25 mm

TYPE	Ø-H (mm)	ORDER CODE
MOVE IN 32	63-93	063-8811117
MOVE IN 45	75-106	063-8812117

MOUNTING HOUSING WITH TRIM
for installation in ceilings from 2-25 mm

TYPE	Ø-H (mm)	ORDER CODE
MOVE IN 32	65-93	063-8821111
MOVE IN 45	77-107	063-8822111

SPECIAL MOUNTING TOOL

TYPE	Ø-H (mm)	ORDER CODE
MOVE IN 32	83-9	063-89111110
MOVE IN 45	100-9	063-89121110

necessary to install mounting housing trimless

Electrical accessories

POWER SUPPLY 220-240 V AC, 50-60 Hz, PC II

TYPE	EFFICIENCY	L-W-H (mm)	ORDER CODE
250 mA non DIM	η 80 %	65-39-20	002-90742
250 mA DALI-2	η 82 %	147-33-23	002-90743
350 mA non DIM	η 85 %	180-30-21	002-90722
350 mA DALI-2	η 83 %	210-30-21	002-90723
400 mA non DIM	η 88 %	180-30-21	002-90724
400 mA DALI-2	η 84 %	210-30-21	002-90725

MOVE IN 32 trimless revision opening required

DIN RAIL COMPONENTS

TYPE	W-H-D (mm)	ORDER CODE
POWER SUPPLY 220-240 V AC	90-90-60	005-6520210
96 W 48 V DC constant voltage		
LED DRIVER DALI-2 DT6 1-2 addr.	36-88-59	005-6121030
200-1050 mA settable const. current		
2 × 42 W 48 V DC U _{OUT} 10-40 V		

for more details and components see page Seite 981

Optical accessories

HONEYCOMB LOUVER

TYPE	Ø-H (mm)	ORDER CODE
MOVE IN flex 32	30-3	007-1965168
MOVE IN flex 45	42-3	007-1965188

INSET POWER is the current consumption excluding any ballast
LUMINOUS FLUX value calculated for 3000 K, CRI ≥ 90, colour white, reflector flood 2700 K -6 %

Hargassner Energy World Linz, AT –
by architekten berger.hofmann og & tech3
Projektentwicklung GmbH with lighting design
by AREA C.I.DESIGN GmbH



← back



MOVE IN 45 square

recessed

EN Square spotlight element in aluminium; powder coated; installation without tools in mounting set (trimless or with trim) with ball catch system; special mounting tool for easy installation of the trimless housing available as an accessory; spotlight element height adjustable without tools: flush with the ceiling, or extended 25 mm or 35 mm; COB (Chip on Board) technology for maximum efficiency; no multiple shadows; energy-efficient LEDs with very good colour rendering; high-quality, aluminium, vapour deposition coated reflector with faceted design; precise radiation characteristic; good glare reduction due to recessed light point plane; optical attachments as accessories

DE Quadratisches Strahlerelement aus Aluminium; pulverbeschichtet; werkzeuglose Montage im Montageset (randlos oder mit umlaufendem Rand) durch Kugelschnappsystem; spezielles Montagewerkzeug zur einfachen Installation des randlosen Gehäuses als Zubehör erhältlich; Strahlerelement werkzeuglos höhenverstellbar: deckenbündig, 25 mm oder 35 mm herausragend; COB (Chip on Board) Technologie für höchste Effizienz; keine Mehrfachschattenbildung; energieeffiziente LEDs mit sehr guter Farbwiedergabe; hochwertiger, aluminiumbedampfter Reflektor mit Facettenoptik; präzise Abstrahlcharakteristik; gute Entblendung durch zurückversetzte Lichtpunktebene; optische Aufsätze als Zubehör

Quickinfo

2700 K, 3000 K
CRI ≥ 90, 3 SDCM
up to 95 lm/W
L80 @ 50 000 h
non DIM, DALI-2

Types

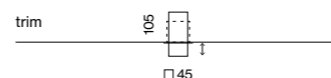
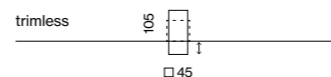

0 - 25 - 35 mm

Inset colours



Housing colours



Light distributions



spot med. flood

Order options

COLOUR TEMPERATURE	
2700 K	4
3000 K	5

INSET COLOUR	
○ traffic white RAL 9016	7
● jet black RAL 9005	8

HOUSING COLOUR	
○ traffic white RAL 9016	7
● silver-grey	G
● jet black RAL 9005	8

BEAM ANGLE	
spot 14°	S
medium 24°	M
flood 39°	F

Options on request

MOUNTING HOUSING	
special colours	

POWER SUPPLY	
DIM 1-10V	

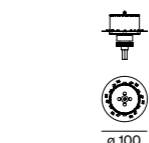
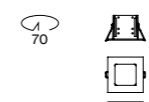
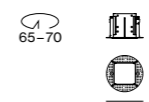
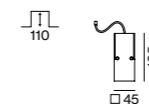

MOVE IN 45 square



SPOTLIGHT incl. connection cable 600 mm

INSET POWER	LUMINOUS FLUX	ORDER CODE
12.8 W 37 Vf 350 mA	spot 1010 lm	0 6 3 - 8 4 2 1 :: 1 ■ S
13.5 W 36 Vf 400 mA	1280 lm	0 6 3 - 8 4 2 1 :: 1 ■ ▲

Mounting accessories

MOUNTING HOUSING TRIMLESS
for installation in plasterboard ceilings 9-25 mm

TYPE	Ø-H (mm)	ORDER CODE
MOVE IN 45	80-54	0 6 3 - 8 8 3 2 1 1 7

MOUNTING HOUSING WITH TRIM
for installation in ceilings from 2-25 mm

TYPE	L-W-H (mm)	ORDER CODE
MOVE IN 45	78-78-55	0 6 3 - 8 8 4 2 1 1 ■

SPECIAL MOUNTING TOOL

TYPE	Ø-H (mm)	ORDER CODE
MOVE IN 45	100-9	0 6 3 - 8 9 1 2 1 1 0

necessary to install mounting housing trimless

Electrical accessories

POWER SUPPLY 220-240 V AC, 50-60 Hz, □ PC II

TYPE	EFFICIENCY	L-W-H (mm)	ORDER CODE
350 mA non DIM	η 85 %	180-30-21	0 0 2 - 9 0 7 2 2
350 mA DALI-2	η 83 %	210-30-21	0 0 2 - 9 0 7 2 3
400 mA non DIM	η 88 %	180-30-21	0 0 2 - 9 0 7 2 4
400 mA DALI-2	η 84 %	210-30-21	0 0 2 - 9 0 7 2 5

DIN RAIL COMPONENTS

TYPE	W-H-D (mm)	ORDER CODE
POWER SUPPLY 220-240 V AC 96 W 48 V DC constant voltage	90-90-60	0 0 5 - 6 5 2 0 2 1 0
LED DRIVER DALI-2 DT6 1-2 addr. 200-1050 mA settable const. current 2 × 42 W 48 V DC U _{OUT} 10-40 V	36-88-59	0 0 5 - 6 1 2 1 0 3 0

for more details and components see page Seite 981

Optical accessories

HONEYCOMB LOUVER

TYPE	Ø-H (mm)	ORDER CODE
MOVE IN 45	42-3	0 0 7 - 1 9 6 5 1 8 8

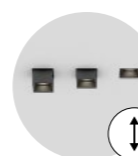

tool-free height adjustment



trimless installation in plasterboard

INSET POWER is the current consumption excluding any ballast
LUMINOUS FLUX value calculated for 3000 K, CRI ≥ 90, colour white, reflector flood 2700 K -6 %



Lampenwelt GmbH Schlitz, DE –
lighting design by Lampenwelt GmbH

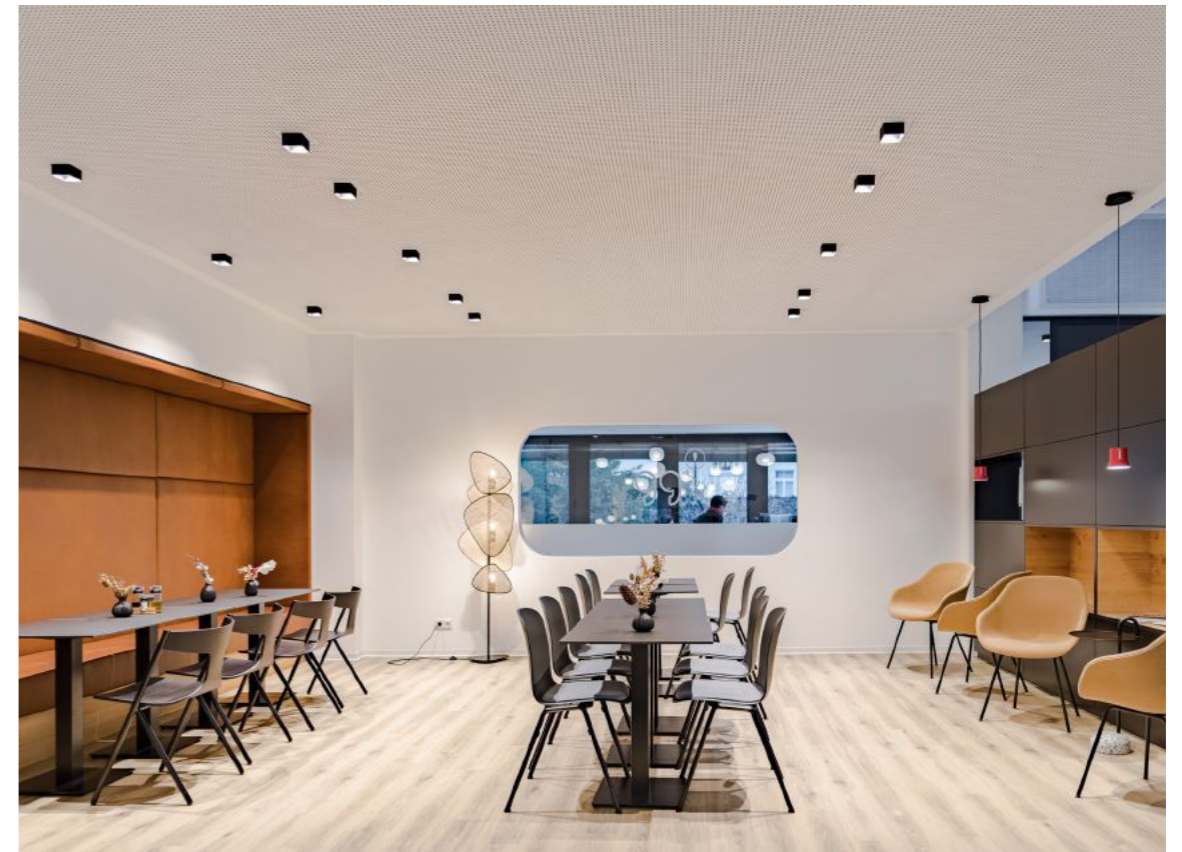

Add a little twist

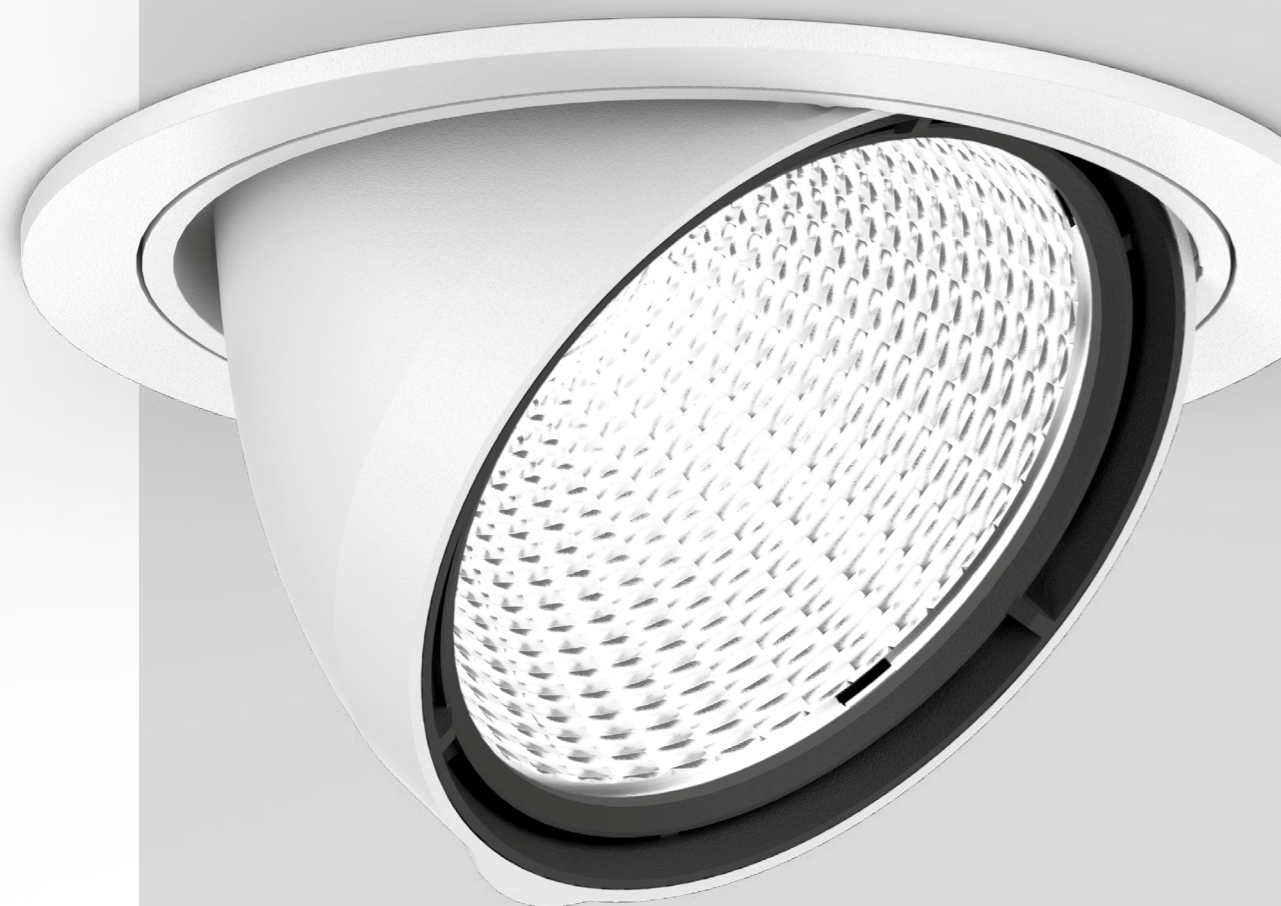

TWIST

EN A round recessed spotlight, ideal for retail. TWIST can be completely recessed into the ceiling or swivelled out and aligned, either bringing it to the fore or making it take a step back. Thanks to its 360° rotation and 45° tilt, it is highly flexible and adapts to evolving conditions in shops. The high-quality reflector produces precise beam characteristics with three different beam angles. TWIST is simply mounted without tools using a ball catch system. Excellent colour rendering value (CRI ≥ 90) at 2700K, 3000K, or 4000K ensures outstanding product presentation.

DE Ein runder Einbaustrahler, ideal für Retail. TWIST macht sich sichtbar oder nimmt sich zurück: Der Strahler kann auf Wunsch völlig in die Decke versetzt oder herausgeschwenkt und ausgerichtet werden. Mit 360° Dreh- und 45° Schwenkbarkeit ist er höchst flexibel und passt sich an neue Gegebenheiten in Shops an. Der hochwertige Reflektor bietet eine präzise Abstrahlcharakteristik mit drei verschiedenen Ausstrahlwinkeln. Mittels Kugelschnappsystem wird TWIST einfach werkzeuglos montiert. Ein sehr guter Farbwiedergabewert (CRI ≥ 90) bei 2700K, 3000K oder 4000K sorgt für exzellente Warenpräsentation.

Types

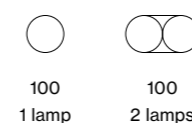

100
1 lamp

100
2 lamps

Mountings

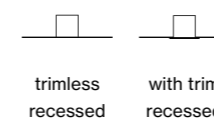

trimless
recessed

with trim
recessed

Light distribution

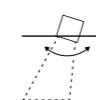

spotlight

← back

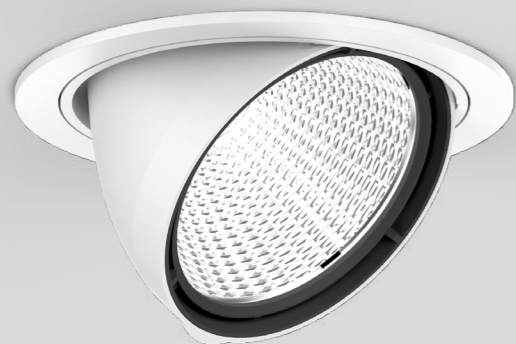
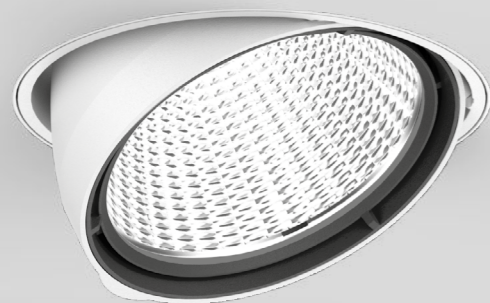

TWIST 100

recessed

EN Round recessed spotlight in die-cast aluminium; powder coated; installation without tools in mounting set (trimless or with trim) with ball catch system; 360° rotatable and 45° tiltable outward; COB (Chip on Board) technology for maximum efficiency; no multiple shadows; energy-efficient LEDs with very good colour rendering; high quality reflector with spherical facet finish; precise radiation characteristic; optical attachments as accessories; optical attachments can be combined

DE Runder Einbaustrahler aus Aluminium-druckguss; pulverbeschichtet; werkzeuglose Montage im Montageset (randlos oder mit umlaufendem Rand) durch Kugelschnappsystem; 360° dreh- und 45° ausschwenkbar; COB (Chip on Board) Technologie für höchste Effizienz; keine Mehrfachschattenbildung; energieeffiziente LEDs mit sehr guter Farbwiedergabe; hochwertiger Reflektor mit sphärischer Facettenoptik; präzise Abstrahlcharakteristik; optische Aufsätze als Zubehör; optische Aufsätze miteinander kombinierbar

Quickinfo

3000K, 4000K
CRI ≥ 90, 3 SDCM
up to 96lm/W
L80 @ 50 000h
non DIM, DALI-2

Types

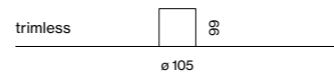
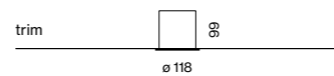

Colours



Light distributions



Order options

COLOUR TEMPERATURE	
3000K	5
4000K	6

CONTROL

non DIM
DALI-2

INSET COLOUR

- traffic white RAL 9016 (UGR ≤ 22) 7
 jet black RAL 9005 (UGR ≤ 16) 8

BEAM ANGLE

spot 17° S
medium 28° M
flood 38° F

Options on request

COLOUR TEMPERATURE

2700K

INSET COLOUR

grey aluminium RAL 9007

MOUNTING SET COLOUR

grey aluminium RAL 9007

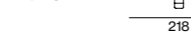
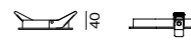
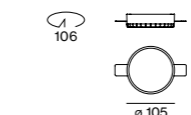

TWIST 100 recessed



SPOTLIGHT ADJUSTABLE

INSET POWER	LUMINOUS FLUX	ORDER CODE
34 W	3250 lm	048-1120::1▲

Mounting accessories

TRIMLESS MOUNTING SET

for installation in plasterboard ceilings 12.5/15/25mm

COLOUR	ORDER CODE
<input type="radio"/> traffic white RAL 9016	048-2796117

MOUNTING SET WITH TRIM for intermediate ceilings 2-25mm

TYPE	COLOUR	ORDER CODE
1 lamp	<input type="radio"/> traffic white RAL9016	048-2796317
	<input checked="" type="radio"/> jet black RAL 9005	048-2796318
2 lamps*	<input type="radio"/> traffic white RAL9016	048-2798317
	<input checked="" type="radio"/> jet black RAL 9005	048-2798318

*do not use in combination with optical accessories

Electrical accessories

POWER SUPPLY 220-240V AC, 50-60Hz, PC II

TYPE	EFFICIENCY	L-W-H (mm)	ORDER CODE
950 mA non DIM	η 89 %	136-43-30	002-90781
950 mA DALI-2	η 85 %	143-43-30	002-90782

THROUGH WIRING CONNECTION BOX

TYPE	L-W-H (mm)	ORDER CODE
non DIM cable ϕ 4-12mm	105-58-30	005-2531110
DALI cable ϕ 4-12mm	105-58-30	005-2551110

Optical accessories

LENS AND HONEYCOMB LOUVER

TYPE	Ø-H (mm)	ORDER CODE
linear prismatic lens	75-9	080-6402110P
honeycomb louver	75-9	080-6401118

SNOOT

TYPE	Ø-H (mm)	ORDER CODE
short	66-23	080-6403118
medium	66-38	080-6403218
angle	66-38	080-6403318

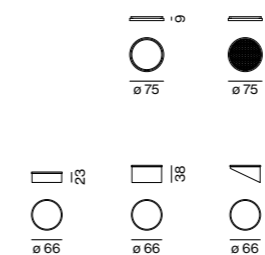

2 lamps mounting set



combine 2 optical accessories



360° rotatable, 45° tiltable

INSET POWER is the current consumption excluding any ballast
LUMINOUS FLUX value calculated for 4000K, CRI ≥ 90, colour white, reflector medium 3000K -7%

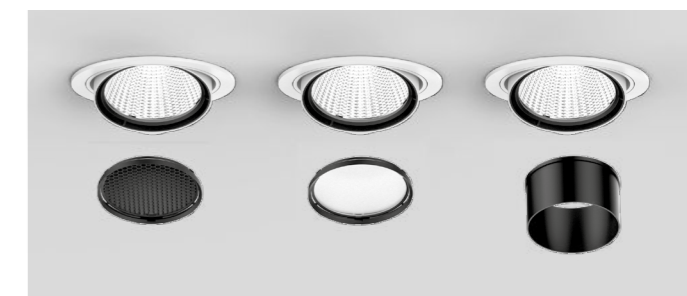

use only one optical accessory



Kastner & Öhler, Kaufhaus Tyrol Innsbruck, AT –
 by DIOMA AG / WHIR3 / K&Ö Bauabteilung with
 lighting design by VEDDER.LICHTMANAGEMENT



Always and anywhere



SPADO

EN One design, two strengths. SPADO's version with a symmetrical beam is used as a downlight. The version with an asymmetrical beam shines as a wallwasher. The recessed light plane creates a discreet overall impression. It makes the chrome-polished reflector, despite its intense illumination and good colour rendering ($CRI \geq 80$), outstandingly glare-free and screen-friendly. SPADO spotlights are simply mounted without tools and are also suitable for wet rooms with its IP 44 protection class. For the light colours, you can choose between 2700K, 3000K or 4000K.

DE Ein Design, zwei Stärken. Mit symmetrischer Abstrahlung wird SPADO als Downlight eingesetzt, während die Version mit asymmetrischer Abstrahlcharakteristik als Wandfluter brilliert. Die zurückversetzte Leuchtenebene erzielt einen dezenten Gesamteindruck, wodurch der chrom-polierter Reflektor trotz intensiver Ausleuchtung und guter Farbwiedergabe ($CRI \geq 80$) hervorragend entblendet und bildschirmtauglich ist. SPADO Strahler werden einfach werkzeuglos montiert und sind gemäß Schutzart IP 44 auch für Nassräume geeignet. Bei den Lichtfarben haben Sie die Wahl zwischen 2700K, 3000K oder 4000K.

Types



round
100

round
150

square
150

Mounting



trim
recessed

Light distributions

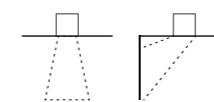

downlight

asymmetric

← back

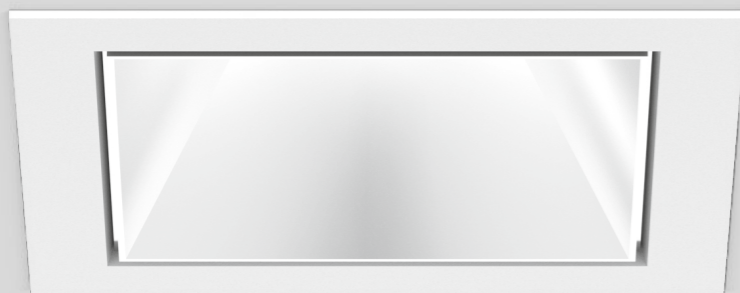

SPADO 100/150

recessed

EN Round or square luminaire housing in die-cast aluminium; with trim; suitable for ceiling thickness of 2-25mm; surface powder coated; installation without tools using snap spring closure; reflector made of polycarbonate, polished chrome; choice of symmetric or asymmetric (only SPADO 150 round trim) radiation characteristic; lighting level recessed; energy-efficient LEDs with very good colour rendering; external converter for ceiling insertion, for through-wiring suitable; operating device suitable for use with a central battery system

DE Runder oder quadratischer Leuchtenkörper aus Aluminiumdruckguss; mit umlaufendem Rand; geeignet für Deckenstärken von 2-25 mm; Oberfläche pulverbeschichtet; werkzeuglose Montage mittels Schnappfederverschluss; Reflektor aus Polycarbonat, chrom-poliert; wahlweise mit symmetrischer oder asymmetrischer (nur SPADO 150 round trim) Abstrahlcharakteristik; Leuchtenebene zurückversetzt; energieeffiziente LEDs mit sehr guter Farbwiedergabe; externer Konverter für Deckeneinwurf, für Weiterverdrahtung geeignet; Betriebsgerät geeignet für den Betrieb an einem Zentralbatterie-System

Quickinfo

3000K, 4000K
CRI ≥ 80, 3 SDCM
up to 118lm/W
L90 @ 50 000h
non DIM, DALI-2
↓ IP44/↑ IP20

Types

SPADO 100



SPADO 150



Colours



Light distributions



Order options

COLOUR TEMPERATURE	
3000K	5
4000K	6

CONTROL	
non DIM	1
DALI-2	3

MATERIAL COLOUR	
○ traffic white RAL 9016	7
● jet black RAL 9005	8

Options on request

COLOUR TEMPERATURE
2700K

MOUNTING SET
acoustic soft ceilings
only for SPADO 100 round trim



DiiA® standards
251, 252, 253



glare control
(UGR ≤ 19)



splash water
protection (IP44)

Light distribution

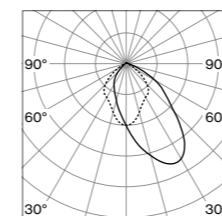

SPADO 150 asymmetric

LUMINOUS FLUX value calculated for 4000K, colour white, reflector chrome 3000K -5%

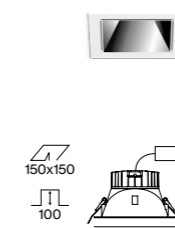
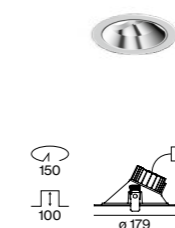
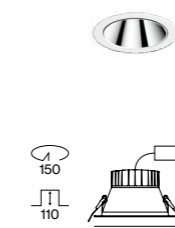
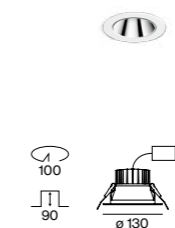

SPADO 100 round trim



DOWNLIGHT (↓ IP44/↑ IP20)

SYSTEM POWER	LUMINOUS FLUX	ORDER CODE
9.3 W	990 lm	0 4 9 - 3 1 1 1 :: 7 O

SPADO 150 round trim



DOWNLIGHT (↓ IP44/↑ IP20)

SYSTEM POWER	LUMINOUS FLUX	ORDER CODE
16.4 W UGR ≤ 19	2350 lm	0 4 9 - 3 1 2 1 :: 7 O
27.5 W	3130 lm	0 4 9 - 3 1 2 3 :: 7 O

SPADO 150 round trim



WALLWASHER ASYMMETRIC (↓ IP44/↑ IP20)

SYSTEM POWER	LUMINOUS FLUX	ORDER CODE
10.7 W	944 lm	0 4 9 - 3 1 2 2 :: 7 O

SPADO 150 square trim



DOWNLIGHT (↓ IP44/↑ IP20)

SYSTEM POWER	LUMINOUS FLUX	ORDER CODE
16.4 W UGR ≤ 19	2380 lm	0 4 9 - 3 1 5 1 :: 7 O
27.5 W	3170 lm	0 4 9 - 3 1 5 2 :: 7 O

Mounting accessories

EXPOSED CONCRETE CEILINGS

TYPE	L-W-H (mm)	ORDER CODE
SPADO 150 round	295-295-160	0 4 9 - 3 1 9 1 2 1 0
SPADO 150 square	400-260-160	0 4 9 - 3 1 9 2 2 1 0

PRIMED CONCRETE CEILINGS

TYPE	Ø-H (mm)	ORDER CODE
SPADO 150 round/square	307-170	0 4 9 - 3 1 9 1 4 1 0

moovel group
Stuttgart, DE –
by FURCH GESTALTUNG +
PRODUKTION GMBH



Sparkasse
Rüsselsheim, DE –
by Zaeske und Partner
Architekten BDA



High-precision shelf lighting

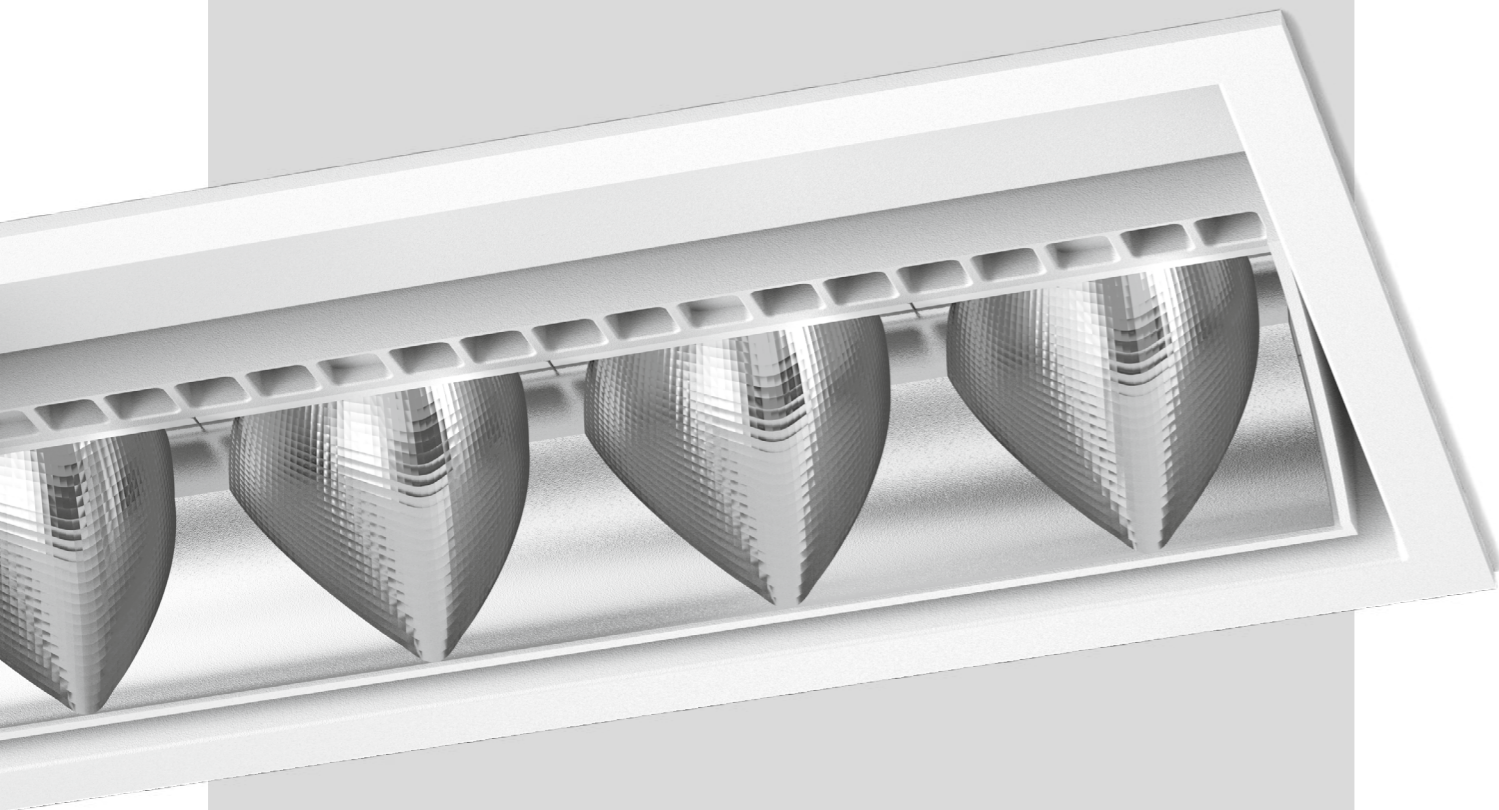

SQUADRO

EN SQUADRO is a track-mounted and recessed spotlight for the retail sector that bundles six essential retail requirements in one luminaire. Free-form reflectors with faceted optics make a polished presentation of goods possible. These reflectors direct the light precisely into shelves or aisle zones. Directed light creates a modelling effect on the products and delivers attractive staging. Swivelling light modules illuminate specific shelf levels or billboards while providing plenty of basic lighting. SQUADRO spotlights are completely glare-free, both transversely and longitudinally. They are highly efficient in their energy balance with an efficiency of over 90%.

DE SQUADRO ist ein Stromschienen- und Einbaustrahler für den Retailbereich, der sechs wichtige Retail-Anforderungen in einer Leuchte bündelt. Die brillante Präsentation von Waren gelingt dank Freiformflächenreflektoren mit Facettenoptik: Diese lenken das Licht punktgenau und hochpräzise in Regale oder Gangzonen. Gerichtetes Licht erzeugt einen Modelling-Effekt auf den Waren und schafft eine attraktive Inszenierung. Schwenkbare Lichtmodule beleuchten gezielt Regalebenen oder Plakatwände und sorgen gleichzeitig für ausreichende Grundbeleuchtung. SQUADRO Strahler sind dabei komplett quer- und längsentblendet und dennoch in ihrer Energiebilanz mit einem Wirkungsgrad von über 90% höchst effizient.

Types



single-sided
1x2

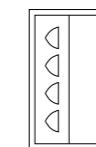

single-sided
1x4

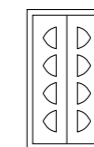

double-sided
2x4

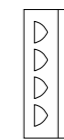

single-sided
1x4

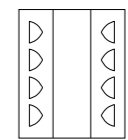

double-sided
2x4

Mountings



recessed



track

Light distributions



wall floor

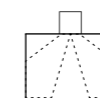

shelf floor



wall/shelf
floor

6-in-1 Lighting solution



EN SQUADRO combines all the advantages of traditional retail lighting solutions in one luminaire. The spotlights are transversely and longitudinally glare-free and direct the light precisely onto the goods – into the heights and depths of the shelves. This achieves a strong product presentation. Thanks to proper light distribution, no additional light source is required for basic lighting.

DE SQUADRO bündelt alle Vorteile klassischer Retail-Lichtlösungen in einer Leuchte. Die Strahler sind quer- und längsentblendet und richten das Licht präzise auf die Ware – bis in die Höhen und Tiefen der Regale. Das erzielt eine starke Produktpräsentation. Dank guter Lichtverteilung ist keine zusätzliche Lichtquelle für die Grundbeleuchtung nötig.

1 EN The highest illuminance is on the upper two presentation levels.

DE Die höchste Beleuchtungsstärke liegt auf den oberen beiden Präsentationsebenen.

2 EN Highlights on premium goods create a brilliant staging.

DE Speziell exklusive Ware wird durch Glanzpunkte attraktiv inszeniert.

3 EN Directed light creates accents on billboards and subjects.

DE Gerichtetes Licht erzeugt Akzente auf Werbetafeln und Sujets.

4 EN The high depth effect gives food high colour contrasts and attractiveness.

DE Durch die hohe Tiefenwirkung erhalten Lebensmittel hohe Farbkontraste und Glanzpunkte.

5 EN Due to longitudinal glare control, the lighting system is barely perceptible to the customer in the direction of the aisle.

DE Durch die Längsentblendung ist die Beleuchtungsanlage für den Kunden in Gangrichtung kaum wahrnehmbar.

6 EN Transverse glare control additionally prevents glare from any viewing direction.

DE Die Querentblendung verhindert zusätzlich Blendung aus jeder Blickrichtung.

Five versions

EN SQUADRO's five variants with diverse beam characteristics respond to different shop layouts and requirements. Perfect alignment ensures that minimal luminaires radiate as much light as possible onto the merchandise. SQUADRO adapts to the conditions and illuminates selectively and without scatter loss. All goods are thus attractively presented regardless of the size or interior design of the shop.

DE SQUADRO antwortet auf unterschiedliche Shop-Layouts und Anforderungen mit fünf Varianten mit verschiedenen Abstrahlcharakteristiken. Damit wenige Leuchten so viel Licht wie möglich auf die Ware strahlen, zählt die perfekte Ausrichtung. SQUADRO passt sich den Gegebenheiten an und beleuchtet punktuell und ohne Streuverluste. So werden alle Waren, unabhängig von Größe oder Innenarchitektur des Shops, ansprechend in Szene gesetzt.

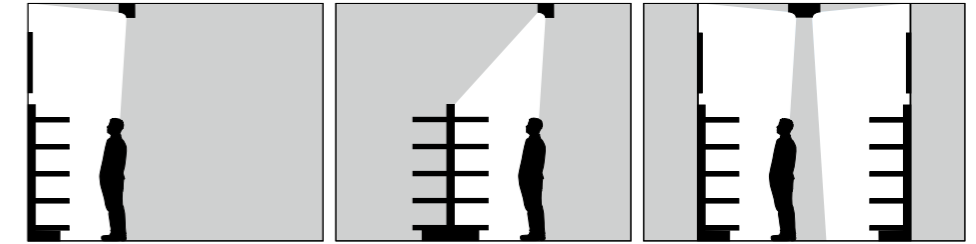

Wall Floor (single-side)

Shelf Floor (single-side)

Wall Floor (double-side)

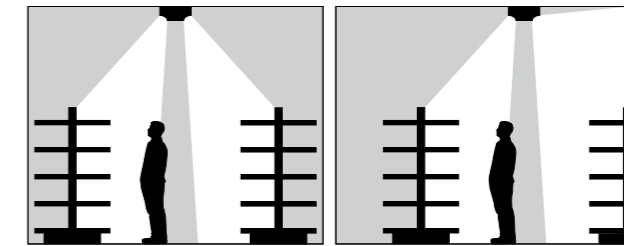

Shelf Floor (double-side)

Shelf / Wall Floor

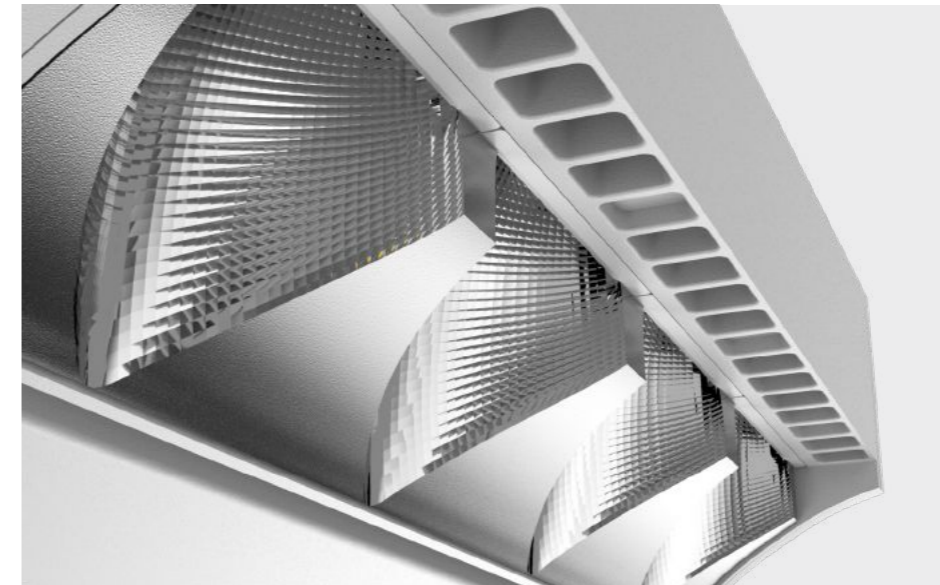

Unique reflector technology

EN Custom free-form reflectors ensure high-precision light control; each SQUADRO achieves an efficiency of over 90 per cent. The spotlights enjoy optimum glare control through the curved shape and secondary reflector technology.

DE Spezielle Freiflächenreflektoren sorgen für hochpräzise Lichtlenkung; jeder SQUADRO erzielt einen Wirkungsgrad von über 90 Prozent. Optimale Entblendung gelingt durch die gekrümmte Form und Sekundärreflektortechnik der Strahler.

Effective lighting

EN Branches of the same chain often differ in their shop architecture. Shelf heights and aisle widths may vary from one location to another. The solution is step-adjustable light modules. The elements can be tilted from -15° to $+20^\circ$. Each module can be tilted asymmetrically, allowing precise alignment and thus optimum light control.

DE Filialen derselben Kette unterscheiden sich häufig in der Shop-Architektur. Regalhöhen und Gangbreiten können sich je nach Standort unterscheiden. Die Lösung: stufenverstellbare Lichtmodule. Die Elemente sind von -15° bis zu $+20^\circ$ kippbar. Jedes Modul kann asymmetrisch geneigt werden und ermöglicht eine präzise Ausrichtung und damit eine optimale Lichtlenkung.

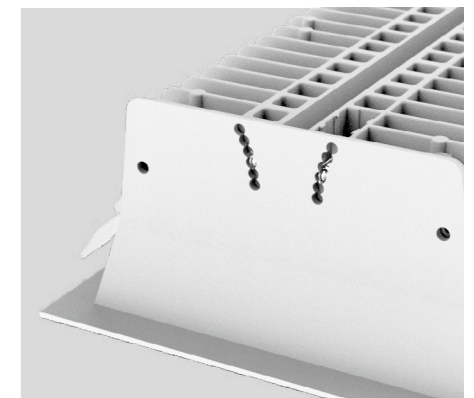

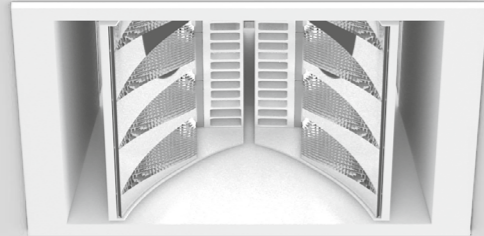
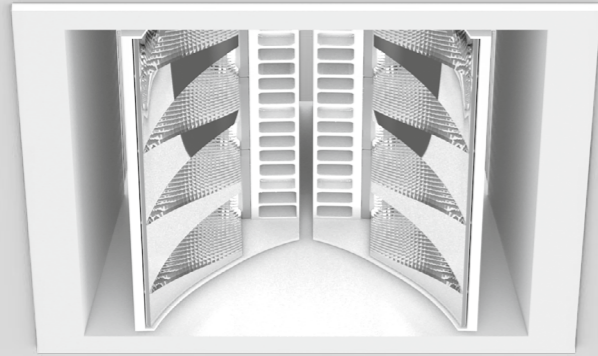

SQUADRO wallwasher

recessed

EN Recessed ceiling spotlight in die cast aluminium in 2 sizes, in different types (2 lamps, 4 lamps or 2 x 4 lamps) and with 2 types of light modules (for shelf floor washer and wall floor washer); with trim; surface powder coated; installation without tools using snap spring closure; aisle spotlight with special, multi-free-form, facet effect surface reflectors for high precision light control; precise shelf and aisle zone lighting, optimum longitudinal glare control for high viewing comfort in the aisle zone, adjustable light modules; COB (Chip on Board) technology for maximum efficiency; efficient LEDs with very good colour rendering; IP 40 protection glass available as an accessory

DE Deckeneinbaustrahler aus Aluminium-druckguss in 2 Größen, in verschiedenen Varianten (2-flammig, 4-flammig bzw. 2 x 4-flammig) und mit 2 verschiedenen Lichtmodulen (für shelf floor washer und wall floor washer); mit umlaufendem Rand; Oberfläche pulverbeschichtet; werkzeuglose Montage mittels Schnappfederverschluss; Gangzonenstrahler mit speziellen Multi-Freiformflächenreflektoren mit Facettenoptik zur äußerst präzisen Lichtlenkung; punktgenaue Regal- und Gangzonenausleuchtung, optimale Längsentblendung für hohen Sehkomfort in der Gangzone, einstellbare Lichtmodule; COB (Chip on Board) Technologie für höchste Effizienz; effiziente LEDs mit sehr guter Farbwiedergabe; IP40-Schutzglas als Zubehör erhältlich

Quickinfo

3000K, 4000K
CRI ≥ 80, 3 SDCM
up to 134lm/W
L80 @ 50000h
non DIM, DALI-2

Types

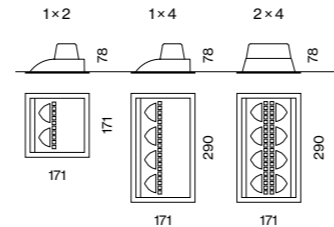

Colours



Light distributions

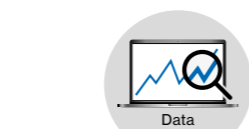
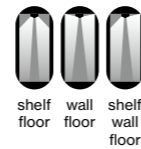

DiiA® standards
251, 252, 253



glare-free reflector
longitudinally &
transversely

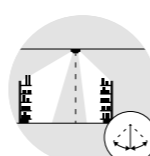

+20° up to -15°
tiltable

Order options

COLOUR TEMPERATURE	
3000K	5
4000K	6

CONTROL	
non DIM	1
DALI-2	3

MATERIAL COLOUR	
○ traffic white RAL 9016	7
● jet black RAL 9005	8

REFLECTOR	
shelf floor washer	S
wall floor washer	A
1 x shelf / 1 x wall floor washer*	B

*only for 2 x 4 lamps

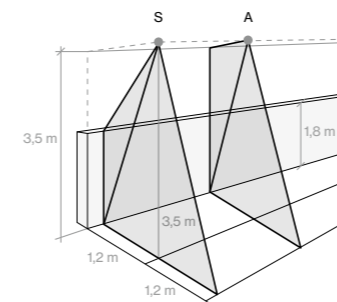

Light distributions

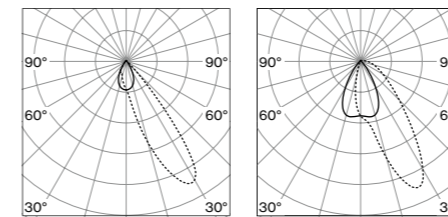

1 x 4 lamps
shelf floor washer

1 x 4 lamps
wall floor washer

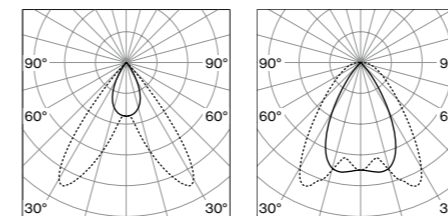

2 x 4 lamps
shelf floor washer

2 x 4 lamps
wall floor washer

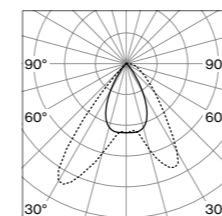

2 x 4 lamps
1 x shelf / 1 x wall floor washer

LUMINOUS FLUX value calculated for 4000K (3000K -5%), colour white, wall floor washer

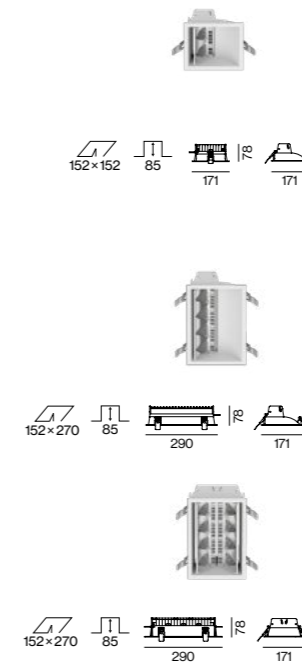

SQUADRO wallwasher trim



1 x 2 LAMPS SINGLE-SIDED

SYSTEM POWER	LUMINOUS FLUX	ORDER CODE
25.3 W	3250 lm	049-2011



1 x 4 LAMPS SINGLE-SIDED

SYSTEM POWER	LUMINOUS FLUX	ORDER CODE
51 W	6490 lm	049-2031

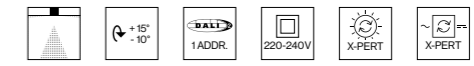

2 x 4 LAMPS DOUBLE-SIDED

SYSTEM POWER	LUMINOUS FLUX	ORDER CODE
86 W	2 x 5760 lm	049-2040
101 W	2 x 6495 lm	049-2041

Optical accessories

IP 40 PROTECTION GLASS

TYPE		ORDER CODE
1 x 2 lamps / single-sided		049-2910010
1 x 4 lamps / single-sided		049-2930010
2 x 4 lamps / double-sided		049-2940010

Technical data

SQUADRO 1 x 4 lamps, shelf wall washer, trim, 51W, 3000K

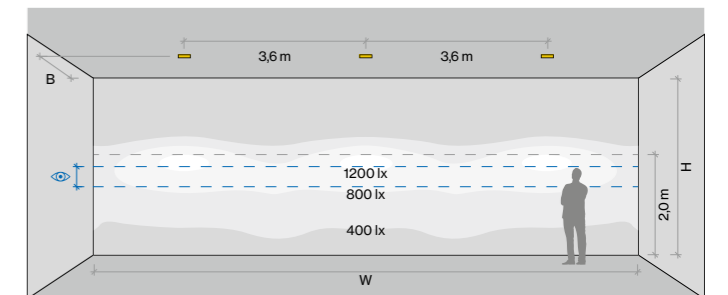

SQUADRO 1 x 4 lamps, wall floor washer, trim, 51W, 3000K

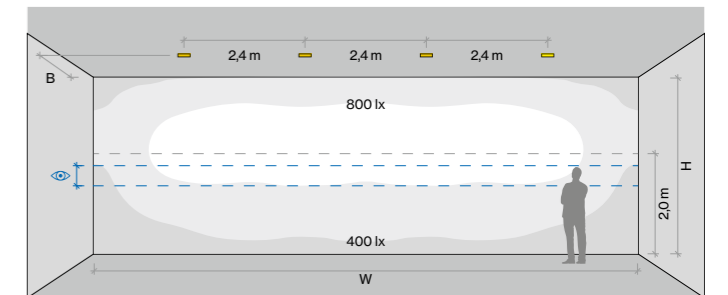

ROOM VALUES		CALCULATION SURFACE	
Wall dimensions	H = 3.5 m W = 10.8 m	Surface dimensions	10.8 x 3.5 m
Distance to wall	B = 1.3 m	Surface height	0 - 3.5 m
Aisle width	2.6 m		
Reflection factor	0.7 0.7 0.2	Eye level	1.35 m - 1.75 m
Maintenance factor	0.9		



Casagrande Luxury Lifestyle
Lucerne, CH –
by Obrist interior AG



← back



SQUADRO wallwasher track

Track light in die cast aluminium in two different types (4 lamps or 2x4 lamps) and with 2 types of light modules (for shelf floor washer and wall floor washer); surface powder coated; aisle spotlight with special, multi-free-form, facet effect surface reflectors for high precision light control; precise shelf and aisle zone lighting, optimum longitudinal glare control for high viewing comfort in the aisle zone, adjustable light modules; COB (Chip on Board) technology for maximum efficiency; efficient LEDs with very good colour rendering; IP40 protection glass available as an accessory; including attachment for linear alignment of the spotlights

Stromschienenstrahler aus Aluminium-druckguss in 2 verschiedenen Varianten (4-flammig bzw. 2x4-flammig) und mit 2 verschiedenen Lichtmodulen (für shelf floor washer und wall floor washer); Oberfläche pulverbeschichtet; Gangzonenstrahler mit speziellen Multi-Freiformflächenreflektoren mit Facettenoptik zur äußerst präzisen Lichtlenkung; punktgenaue Regal- und Gangzonenausleuchtung, optimale Längsentblendung für hohen Sehkomfort in der Gangzone, einstellbare Lichtmodule; COB (Chip on Board) Technologie für höchste Effizienz; effiziente LEDs mit sehr guter Farbwiedergabe; IP40-Schutzglas als Zubehör erhältlich; inklusive Aufsatz zur linearen Ausrichtung der Strahler

Quickinfo

3000K, 4000K
CRI ≥ 80, 3 SDCM
up to 134lm/W
L80 @ 50 000h
non DIM, DALI-2

Types

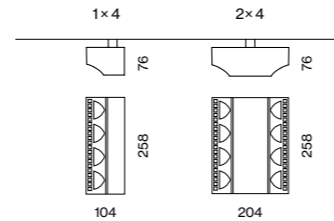

Colours



Light distributions

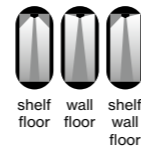

Order options

COLOUR TEMPERATURE	
3000K	5
4000K	6

CONTROL	
non DIM	1
DALI-2	3

MATERIAL COLOUR	
○ traffic white RAL 9016	7
● jet black RAL 9005	8

REFLECTOR	
shelf floor washer	S
wall floor washer	A
1x shelf / 1x wall floor washer*	B

*only for 2x4 lamps

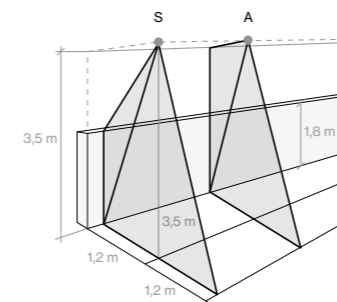

Light distributions

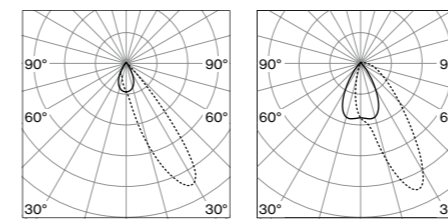

1x4 lamps shelf floor washer | 1x4 lamps wall floor washer

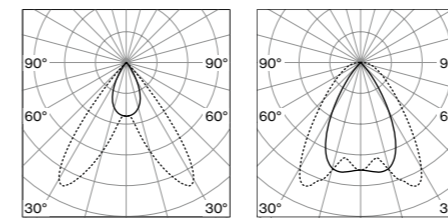

2x4 lamps shelf floor washer | 2x4 lamps wall floor washer

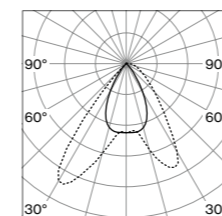

2x4 lamps 1x shelf / 1x wall floor washer

LUMINOUS FLUX value calculated for 4000K (3000K -5%), colour white, wall floor washer



DiiA® standards 251, 252, 253

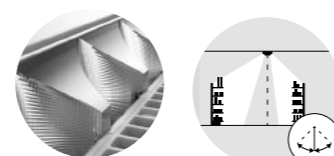

glare-free reflector longitudinally & transversely | +20° up to -15° tiltable

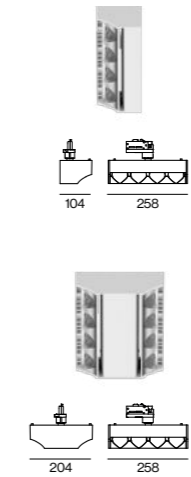

SQUADRO wallwasher track



1x4 LAMPS SINGLE-SIDED

SYSTEM POWER	LUMINOUS FLUX	ORDER CODE
51W	6610lm	149-2231



2x4 LAMPS DOUBLE-SIDED

SYSTEM POWER	LUMINOUS FLUX	ORDER CODE
86W	2x5760lm	149-2240
101W	2x6490lm	149-2241

Optical accessories

IP 40 PROTECTION GLASS

TYPE	ORDER CODE
1x4 lamps/single-sided	049-2930010
2x4 lamps/double-sided	049-2940010

Technical data

SQUADRO shelf floor washer, 1x4 lamps, +5° tilt, 51W, 3000K

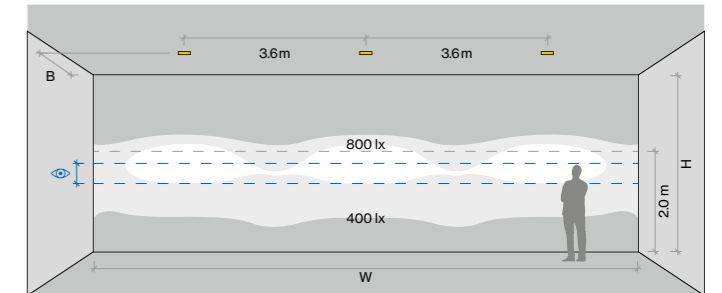

SQUADRO wall floor washer, 1x4 lamps, +5° tilt, 51W, 3000K

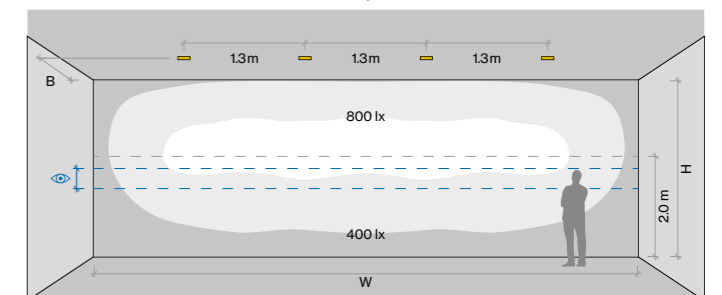

ROOM VALUES		CALCULATION SURFACE	
Wall dimensions	H = 3.5m W = 10.8m	Surface dimensions	10.8 x 3.5m
Distance to wall	B = 1.3m	Surface height	0 - 3.5m
Aisle width	2.6m	Eye level	1.35m - 1.75m
Reflection factor	0.7 0.7 0.2	Maintenance factor	0.9

Jelmoli Store
Zurich, CH



Oasis Store Melbourne, AU –
by Sync Design



Sutterlüthy Rankweil, AT –
by Hermann Kaufmann + Partner ZT GmbH



In the spotlight



BO

EN Beautiful design and flexibility distinguish the BO series of ceiling and track-mounted spotlights. Multiple sizes and different beam angles deliver great freedom in staging. The individual spotlights are available as semi-recessed or surface-mounted variants or as single or dual-lamp spotlights in an elegant base with an integrated driver, as well as track-mounted spotlights. Different housing and light colours (2700 K, 3000 K, or 4000 K) offer flexibility in different architectural concepts, and different versions promise excellent colour rendering with up to CRI ≥ 95 (2-SDCM). The spots can be rotated up to 360° and swivelled 90°, making BO an ideal spotlight for shops and display areas.

DE Formschön und flexibel: das zeichnet die Decken- sowie Stromschienenstrahlerserie BO aus. Durch mehrere Größen und verschiedene Ausstrahlwinkel haben Sie große Freiheit bei der Inszenierung. Die Einzelstrahler sind als Halbeinbau- oder Anbauvariante und als ein- oder zweiflämmiger Strahler in einem eleganten Gehäuse mit integriertem Driver sowie als Stromschienenstrahler erhältlich. Verschiedene Gehäuse- und Lichtfarben (2700 K, 3000 K oder 4000 K) bieten Flexibilität in unterschiedlichen architektonischen Konzepten und versprechen eine sehr gute Farbwiedergabe von bis zu CRI ≥ 95 (2-SDCM). Die Spots sind bis zu 360° dreh- und 90° schwenkbar und machen BO zu einem idealen Strahler für Shops und Präsentationsflächen.

Types



32

45

55

70

Mountings

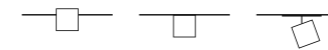

semi-recessed

surface

track

Light distribution

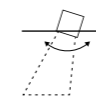

spotlight

Matched proportions

EN Elegance in the right measure: All BO product family spotlights are characterised by their decorative and simple aesthetics. Thanks to their reduced design and precisely coordinated proportions, all BO models can be combined with each other.

DE Eleganz im richtigen Maß: Alle Strahler der BO Produktfamilie zeichnen sich durch ihre dekorative und schlichte Ästhetik aus. Dank ihres reduzierten Designs und den exakt aufeinander abgestimmten Proportionen sind sämtliche BO-Varianten miteinander kombinierbar.



Colour variety

EN BO is available in standard white and black. For even more design freedom, additional colour options are available so that you can tailor BO to your individual project. Learn more about our colour palette at xal.com/colours.

DE BO ist in den Standardfarben Weiß und Schwarz erhältlich. Für noch mehr Gestaltungsfreiraum stehen weitere Farbvarianten zur Verfügung – so können Sie BO Ihrem individuellen Projekt anpassen. Mehr zu unserer Farbpalette erfahren Sie auf xal.com/colours.



xal.com/colours

Intrack

EN Flexible adjustment – easy installation: In the track version, BO combines different sizes and beam angles. Thus, ever new lighting scenarios can be implemented: from the selective presentation of goods and products to the staging of art objects and home accessories. The converter disappears elegantly into the track.

DE Flexible Adjustierung – einfache Montage: In der Track-Variante vereint BO unterschiedliche Größen und Ausstrahlwinkel. So lassen sich immer wieder neue Lichtszenierungen realisieren: von der punktuellen Waren- und Produktpräsentation bis zur Inszenierung von Kunstobjekten und Wohnaccessoires. Der Konverter verschwindet elegant in der Schiene.

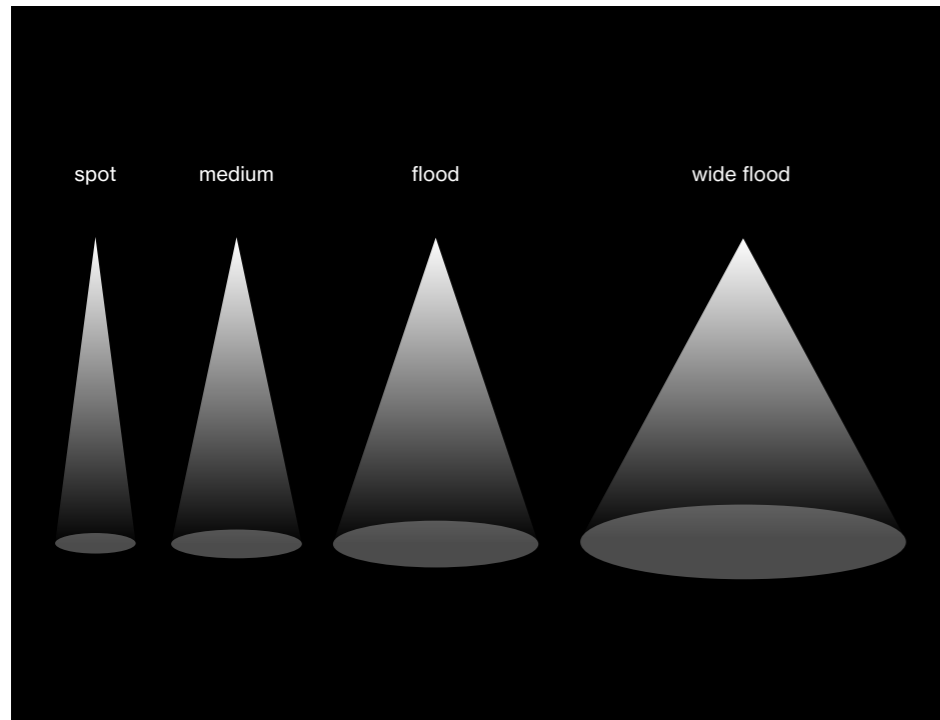

Flexible adjustment

EN BO adapts to the requirements to ensure that objects are presented in the best possible light. The spotlight comes in different beam angles and is rotatable by at least 360°, as well as 90° tiltable.

DE Damit Objekte bestmöglich in Szene gesetzt sind, passt sich BO den Anforderungen an. Der Strahler ist nicht nur in verschiedenen Ausstrahlwinkeln verfügbar sondern auch um mindestens 360° dreh- sowie 90° schwenkbar.

Variety

EN The individual spotlights are available as semi-recessed or surface-mounted versions or as single or double-flame spotlights in an elegant housing. Different housing and light colours (2700 K, 3000 K, or 4000 K) offer flexibility for unique projects.

DE Die Einzelstrahler sind als Halbeinbau- oder Anbauvariante bzw. als ein- oder zweiflammiger Strahler in einem eleganten Gehäuse erhältlich. Verschiedene Gehäuse- und Lichtfarben (2700 K, 3000 K oder 4000 K) bieten Flexibilität für einzigartige Projekte.

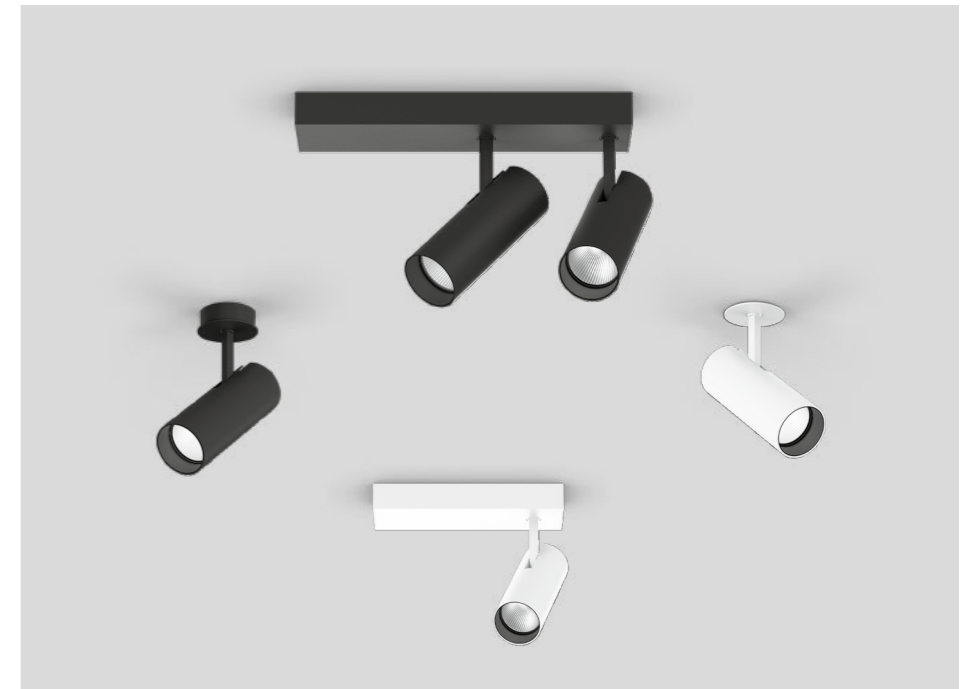

← back



BO 32 / 45 / 55

semi-recessed / surface

EN Cylindrical spotlight made of aluminium; surface powder coated; either with surface mounted housing or as ceiling recessed variant; spotlight head 350° rotatable and 90° tilt; high-quality, aluminium, vapour deposition coated reflector with faceted design; precise radiation characteristics with different beam angles; good glare reduction due to recessed light point plane; optical attachments as accessories; COB (Chip on Board) technology for maximum efficiency; no multiple shadows; energy-efficient LEDs with very good colour rendering

DE Zylindrischer Strahler aus Aluminium; Oberfläche pulverbeschichtet; wahlweise mit Anbaueinheit oder als Deckeneinbaueinheit; Strahlerkopf 350° dreh- und 90° schwenkbar; hochwertiger, aluminiumbedampfter Reflektor mit Facettenoptik; präzise Abstrahlcharakteristik mit verschiedenen Ausstrahlwinkeln; gute Entblendung durch zurückversetzte Lichtpunktebene; optische Aufsätze als Zubehör; mit COB (Chip on Board) Technologie für höchste Effizienz; keine Bildung von Mehrfachschatten; energieeffiziente LEDs mit sehr guter Farbwiedergabe

Quickinfo

2700 K, 3000 K
 CRI ≥ 90, 2 SDCM
 BO 32 up to 91 lm/W
 BO 45 up to 103 lm/W
 BO 55 up to 92 lm/W
 L80 @ 50 000 h
 non DIM, DALI-2

Types

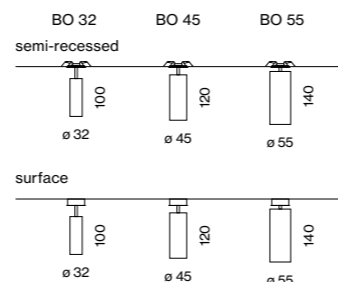

Colours

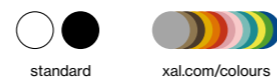

Light distributions

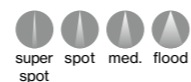

Order options

MOUNTING	
semi-recessed ceiling clip	1
surface housing	2

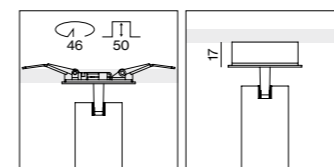

COLOUR TEMPERATURE	
2700 K	4
3000 K	5

MATERIAL COLOUR	
○ traffic white RAL 9016	7
● jet black RAL 9005	8
● special colours* p. 992	X

*canopy always in white

BEAM ANGLE BO 32	
spot 18°	S
medium 23°	M
flood 37°	F

BEAM ANGLE BO 45	
super spot 8°	V
spot 14°	S
medium 24°	M
flood 39°	F

BEAM ANGLE BO 55	
spot 17°	S
medium 23°	M
flood 37°	F

Options on request

COLOUR RENDERING INDEX	
CRI ≥ 95, 2 SDCM	

COLOUR TEMPERATURE	
4000 K	

CONTROL	
Casambi	

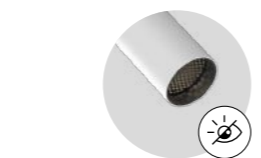

glare control via honeycomb louver



350° rotatable, 90° tilttable



CRI ≥ 95, 2 SDCM

LUMINOUS FLUX value calculated for 3000 K, colour white, reflector flood 2700 K -6%

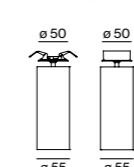
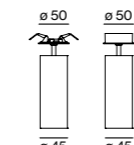
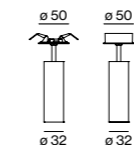

BO 32 semi-recessed / surface



ADJUSTABLE		
INSET POWER	LUMINOUS FLUX	ORDER CODE
8.8 W 36 Vf 250 mA	755 lm	0 4 9 - 6 5 2 0 :: 1 ▣ ▲

BO 45 semi-recessed / surface



ADJUSTABLE		
INSET POWER	LUMINOUS FLUX	ORDER CODE
6.1 W 11 Vf 400 mA	super spot 297 lm	0 4 9 - 6 5 3 0 :: 1 ▣ V
12.8 W 37 Vf 350 mA	spot 1030 lm	0 4 9 - 6 5 3 0 :: 1 ▣ S
13.5 W 36 Vf 400 mA	medium, flood 1320 lm	0 4 9 - 6 5 3 0 :: 1 ▣ ▲

BO 55 semi-recessed / surface



ADJUSTABLE		
INSET POWER	LUMINOUS FLUX	ORDER CODE
21.1 W 36 Vf 600 mA	1850 lm	0 4 9 - 6 5 4 0 :: 1 ▣ ▲

Electrical accessories

POWER SUPPLY 220-240 V AC, 50-60 Hz, PC II

TYPE	EFFICIENCY	L-W-H (mm)	ORDER CODE
250 mA non DIM	η 80 %	65-39-20	0 0 2 - 9 0 7 4 2
250 mA DALI-2	η 82 %	147-33-23	0 0 2 - 9 0 7 4 3
350 mA non DIM	η 85 %	180-30-21	0 0 2 - 9 0 7 2 2
350 mA DALI-2	η 83 %	210-30-21	0 0 2 - 9 0 7 2 3
400 mA non DIM	η 88 %	180-30-21	0 0 2 - 9 0 7 2 4
400 mA DALI-2	η 84 %	210-30-21	0 0 2 - 9 0 7 2 5
600 mA non DIM	η 87 %	210-30-21	0 0 2 - 9 0 7 2 6
600 mA DALI-2	η 85 %	210-30-21	0 0 2 - 9 0 7 2 7

for surface versions revision opening required

DIN RAIL COMPONENTS

TYPE	W-H-D (mm)	ORDER CODE
POWER SUPPLY 220-240 V AC	90-90-60	0 0 5 - 6 5 2 0 2 1 0
96 W 48 V DC constant voltage		
LED DRIVER DALI-2 DT6 1-2 addr.	36-88-59	0 0 5 - 6 1 2 1 0 3 0
200-1050 mA settable const. current		
2 x 42 W 48 V DC U _{OUT} 10-40 V		

for more details and components see page 981

Optical accessories

HONEYCOMB LOUVER

TYPE	Ø-H (mm)	ORDER CODE
BO 32	30-3	0 0 7 - 1 9 6 5 1 6 8
BO 45	42-3	0 0 7 - 1 9 6 5 1 8 8
BO 55	50-3	0 0 7 - 1 9 6 5 5 9 8

Complexe des opérations Payerne CH –
by op-arch, Oester Pfenninger, Ulrich
Weiz including lighting design





Wohnhaus Pferdeblick, AT –
by Baukooperative GmbH
including lighting design

Einrichtungshaus Grimm
Göppingen, DE –
by Studio Komo





BO 45 base surface

EN Cylindrical spotlight made of aluminium; surface powder coated; spotlight head 350° / 330° (1 lamp / 2 lamps) rotatable and 90° tiltable; choice of single lamp or double lamps; surface mounted housing in aluminium incl. converter; mounting plate with pre-assembled converter unit can be pre-mounted; luminaire housing can be attached without tools by interlock; high-quality, aluminium, vapour deposition coated reflector with faceted design; precise radiation characteristics with different beam angles; good glare reduction due to recessed light point plane; optical attachments as accessories; COB (Chip on Board) technology for maximum efficiency; no multiple shadows; energy-efficient LEDs with very good colour rendering

DE Zylindrischer Strahler aus Aluminium; Oberfläche pulverbeschichtet; Strahlerkopf 350° / 330° (1-flammig / 2-flammig) dreh- und 90° schwenkbar; wahlweise einflammig oder zweiflammig; Anbaugehäuse aus Aluminium inkl. Konverter; Montageplatte mit vormontierter Konvertereinheit vorab montierbar; Leuchtenkörper mittels Verriegelung werkzeuglos aufsetzbar; hochwertiger, aluminiumbedampfter Reflektor mit Facettenoptik; präzise Abstrahlcharakteristik mit verschiedenen Ausstrahlwinkeln; gute Entblendung durch zurückversetzte Lichtpunktebene; optische Aufsätze als Zubehör; mit COB (Chip on Board) Technologie für höchste Effizienz; keine Bildung von Mehrfachschatten; energieeffiziente LEDs mit sehr guter Farbwiedergabe

Quickinfo

2700 K, 3000 K
CRI ≥ 90, 2 SDCM
1 lamp up to 86 lm/W
2 lamps up to 96 lm/W
L80 @ 50 000 h
non DIM, DALI-2

Types

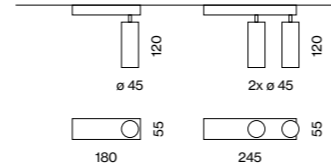

Colours



Light distributions



Order options

COLOUR TEMPERATURE	
2700 K	4
3000 K	5

CONTROL	
non DIM	1
DALI-2	3

MATERIAL COLOUR	
○ traffic white RAL 9016	7
● jet black RAL 9005	8
● special colours* p. 992	X

*base always in white

BEAM ANGLE	
super spot 8°	V
spot 14°	S
medium 24°	M
flood 39°	F

Options on request

COLOUR RENDERING INDEX
CRI ≥ 95, 2 SDCM

COLOUR TEMPERATURE
4000 K

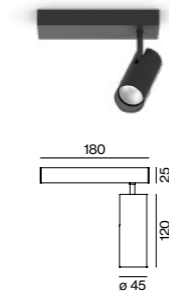

BO 45 base surface



1 LAMP

SYSTEM POWER	LUMINOUS FLUX	ORDER CODE
7.2 W	super spot 297 lm	0 4 9 - 6 3 3 0 :: ▽ ▽ V
15.1 W	spot 1030 lm	0 4 9 - 6 3 3 0 :: ▽ ▽ S
15.9 W	medium, flood 1310 lm	0 4 9 - 6 3 3 0 :: ▽ ▽ ▲

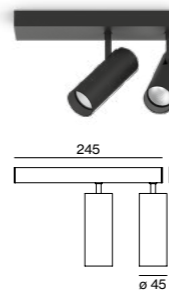

BO 45 base surface



2 LAMPS

SYSTEM POWER	LUMINOUS FLUX	ORDER CODE
14.4 W	super spot 2 × 297 lm	0 4 9 - 6 4 3 0 :: ▽ ▽ V
30 W	spot 2 × 1030 lm	0 4 9 - 6 4 3 0 :: ▽ ▽ S
27.5 W	medium, flood 2 × 1220 lm	0 4 9 - 6 4 3 0 :: ▽ ▽ ▲

Optical accessories

HONEYCOMB LOUVER

TYPE	Ø-H (mm)	ORDER CODE
BO 45	42-3	0 0 7 - 1 9 6 5 1 8 8



glare control via
honeycomb louver



350° rotatable,
90° tiltable



CRI ≥ 95,
2 SDCM

LUMINOUS FLUX value calculated for 3000 K, CRI ≥ 90, colour white, flood 2700 K -6%

möbelbau breithaler gmbh
Leibnitz, AT – by möbelbau
breithaler gmbh



Quickinfo

2700 K, 3000 K, 4000 K
 CRI ≥ 90, 2 SDCM
 BO 32 up to 69 lm/W
 BO 45 up to 87 lm/W
 BO 55 up to 78 lm/W
 L80 @ 50 000 h
 non DIM, DALI-2

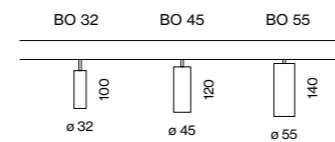
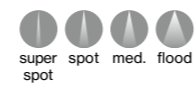
Types**Colours****Light distributions****Order options**

COLOUR TEMPERATURE	☐☐☐
2700 K	4
3000 K	5
4000 K	6

CONTROL	⬆️⬆️
non DIM	1
DALI-2	3

MATERIAL COLOUR

☐ traffic white RAL 9016	7
● jet black RAL 9005	8
🌈 special colours p.992	X

BEAM ANGLE BO 32

spot 18°	S
medium 23°	M
flood 37°	F

BEAM ANGLE BO 45

super spot 8°	V
spot 14°	S
medium 24°	M
flood 39°	F

BEAM ANGLE BO 55

spot 17°	S
medium 23°	M
flood 37°	F

Options on request**COLOUR RENDERING INDEX**

CRI ≥ 95, 2 SDCM

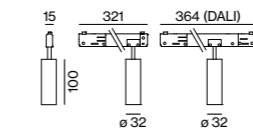
**BO 32 intrack****TRACK LIGHT**

SYSTEM POWER	LUMINOUS FLUX	ORDER CODE
11.7 W	755 lm	180-71111 ☐☐☐☐☐☐

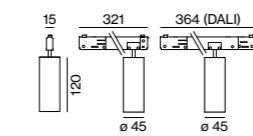
**BO 45 intrack****TRACK LIGHT**

SYSTEM POWER	LUMINOUS FLUX	ORDER CODE
6.1 W	super spot 297 lm	180-72111 ☐☐☐☐☐☐ V
15.1 W	spot 1030 lm	180-72111 ☐☐☐☐☐☐ S
15.9 W	medium, flood 1320 lm	180-72111 ☐☐☐☐☐☐ ▲

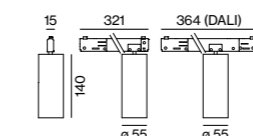
**BO 55 intrack****TRACK LIGHT**

SYSTEM POWER	LUMINOUS FLUX	ORDER CODE
24.8 W	1840 lm	180-73111 ☐☐☐☐☐☐ ▲

Optical accessories**HONEYCOMB LOUVER**

TYPE	Ø H (mm)	ORDER CODE
BO 32	30·3	007-1965168
BO 45	42·3	007-1965188
BO 55	50·3	007-1965598

BO 32/45/55

intrack

EN Track light made of die-cast aluminium; surface powder coated; spotlight head rotates 360° and tilts 90°; converter integrated in the power track adapter; high-quality, aluminium, vapour deposition coated reflector with faceted design; precise radiation characteristics with different beam angles; good glare reduction due to recessed light point plane; optical attachments as accessories; COB (Chip on Board) technology for maximum efficiency; no multiple shadows; energy-efficient LEDs with very good colour rendering; adapter for toolless insertion or movement on a variety of 3-phase power tracks; adapter flush with the power track

DE Stromschienenstrahler aus Aluminium-druckguss; Oberfläche pulverbeschichtet; Strahlerkopf 360° dreh- und 90° schwenkbar; Konverter im Stromschienen-Adapter integriert; hochwertiger, aluminiumbedampfter Reflektor mit Facettenoptik; präzise Abstrahlcharakteristik mit verschiedenen Ausstrahlwinkeln; gute Entblendung durch zurückversetzte Lichtpunktebene; optische Aufsätze als Zubehör; mit COB (Chip on Board) Technologie für höchste Effizienz; keine Bildung von Mehrfachschatten; energieeffiziente LEDs mit sehr guter Farbwiedergabe; Adapter für werkzeugloses Einsetzen bzw. Verschieben in verschiedenen 3-Phasen Stromschienen; Adapter bündig mit Stromschiene abschließend



glare control via honeycomb louver



360° rotatable, 90° tiltable



CRI ≥ 95, 2 SDCM

LUMINOUS FLUX value calculated for 3000 K, CRI ≥ 90, colour white, flood 2700 K -5%, 4000 K +7%



Oberpollinger | The KaDeWe Group
Munich, DE – by Licht Kunst Licht AG
including lighting design



Optiek Sagaert Zwevegem BE –
by Courtois & Châtelain and
Entirus Group



Quickinfo

3000K, 4000K
 CRI ≥ 90 2-SDCM
 up to 87lm/W
 L80 @ 50 000h
 non DIM, DALI-2

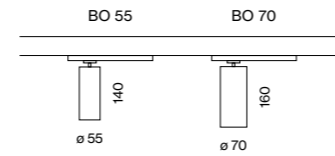
Types**Colours****Light distributions**

BO 55



BO 70

**Order options**

COLOUR TEMPERATURE	☐☐☐
3000K	5
4000K	6

CONTROL	⬆️⬆️
non DIM	1
DALI-2	3

MATERIAL COLOUR	☑️
☐ traffic white RAL 9016	7
● jet black RAL 9005	8

BEAM ANGLE BO 55	▲
spot 17°	S
medium 24°	M
flood 40°	F

BEAM ANGLE BO 70	▲
spot 15°	S
medium 23°	M
flood 37°	F
wide flood 57°	W

Options on request

COLOUR RENDERING INDEX	
CRI ≥ 95, 2 SDCM	

CONTROL

Casambi

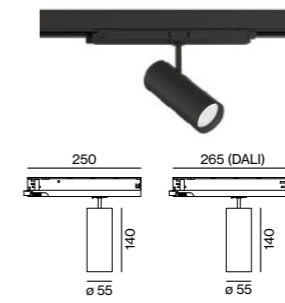
**BO 55 track****TRACK LIGHT**

SYSTEM POWER	LUMINOUS FLUX	ORDER CODE
24.8 W	2150 lm	180-7312::☐☐▲

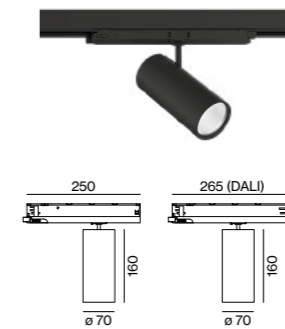
**BO 70 track****TRACK LIGHT**

SYSTEM POWER	LUMINOUS FLUX	ORDER CODE
40 W	3410 lm	180-7411::☐☐▲

Optical accessories**HONEYCOMB LOUVER**

TYPE	Ø H (mm)	ORDER CODE
BO 55	50-3	007-1965598
BO 70	61-3	080-5900018

BO 55/70

track

EN Track light made of die-cast aluminium; surface powder coated; spotlight head 355° rotatable and 90° tiltable; converter integrated in the power track adapter; high-quality, aluminium, vapour deposition coated reflector with faceted design; precise radiation characteristics with different beam angles; good glare reduction due to recessed light point plane; optical attachments as accessories; COB (Chip on Board) technology for maximum efficiency; no multiple shadows; energy-efficient LEDs with very good colour rendering; adapter for toolless insertion or movement on a variety of 3-phase power tracks

DE Stromschienenstrahler aus Aluminium-druckguss; Oberfläche pulverbeschichtet; Strahlerkopf 355° dreh- und 90° schwenkbar; Konverter im Stromschienen-Adapter integriert; hochwertiger, aluminiumbedampfter Reflektor mit Facettenoptik; präzise Abstrahlcharakteristik mit verschiedenen Ausstrahlwinkeln; gute Entblendung durch zurückversetzte Lichtpunktebene; optische Aufsätze als Zubehör; mit COB (Chip on Board) Technologie für höchste Effizienz; keine Bildung von Mehrfachschatten; energieeffiziente LEDs mit sehr guter Farbwiedergabe; Adapter für werkzeugloses Einsetzen bzw. Verschieben in verschiedenen 3-Phasen Stromschienen



glare control via honeycomb louver



355° rotatable, 90° tiltable



CRI ≥ 90, 2 SDCM

LUMINOUS FLUX value calculated for 3000K, CRI ≥ 90, colour white, flood 4000K +5%

Shop SVNTY Antwerp, BE –
by Verhamme de vel Architecten
with lighting design by Electro Govaerts



Universal expert



VARO

EN As a track-mounted spotlight, VARO focuses on the essentials and can be used universally. It is available in two different sizes and, thanks to its 355° rotation and 90° swivelling capability, is extremely flexible in use. This flexibility is supported by the fact that the spotlights can be inserted and moved along the track without tools. It is ideal for use in shops whose interior design is continually evolving. The high-quality reflector from VARO ensures a particularly precise beam characteristic at different angles, all with an excellent colour rendering up to $\text{CRI} \geq 95$. Depending on the desired spatial effect, you can choose between the 3000 K and 4000 K light colours.

DE Als Stromschiene Strahler fokussiert VARO auf das Wesentliche und ist universell einsetzbar. Er ist in zwei verschiedenen Größen verfügbar und durch 355° Dreh- und 90° Schwenkbarkeit höchst beweglich im Einsatz. Unterstützt wird diese Flexibilität durch werkzeugloses Einsetzen und Verschieben der Strahler in der Stromschiene: ideal für den Einsatz in Shops, deren Innenarchitektur sich immer wieder verändert. Der hochwertige Reflektor von VARO sorgt für eine besonders präzise Abstrahlcharakteristik in verschiedenen Winkeln – und das bei sehr guter Farbwiedergabe von bis zu $\text{CRI} \geq 95$. Je nach gewünschter Raumwirkung haben Sie die Wahl zwischen den Lichtfarben 3000 K und 4000 K.

Types



80



110

Mounting



track

Light distribution



spotlight

← back



VARO 80 S

track

EN Track light made of die-cast aluminium; surface powder coated; spotlight head 355° rotatable and 90° tiltable; integrated converter in the plastic adapter; high quality reflector with spherical facet finish; precise radiation characteristics with different beam angles; installed and exchanged without tools; optical attachments as accessories; optical attachments can be combined; COB (Chip on Board) technology for maximum efficiency; no multiple shadows; energy-efficient LEDs with very good colour rendering; adapter for toolless insertion or movement on a variety of 3-phase power tracks

DE Stromschienenstrahler aus Aluminium-druckguss; Oberfläche pulverbeschichtet; Strahlerkopf 355° dreh- und 90° schwenkbar; Konverter im Kunststoffadapter integriert; hochwertiger Reflektor mit sphärischer Facetenoptik; präzise Abstrahlcharakteristik mit verschiedenen Ausstrahlwinkeln; werkzeuglos einsetz- bzw. austauschbar; optische Aufsätze als Zubehör; optische Aufsätze miteinander kombinierbar; mit COB (Chip on Board) Technologie für höchste Effizienz; keine Bildung von Mehrfachschatten; energieeffiziente LEDs mit sehr guter Farbwiedergabe; Adapter für werkzeugloses Einsetzen bzw. Verschieben in verschiedenen 3-Phasen Stromschienen

Quickinfo

3000K, 4000K
 CRI ≥ 90, 3 SDCM
 up to 91lm/W
 L80/50 000h
 non DIM, DALI-2

Type

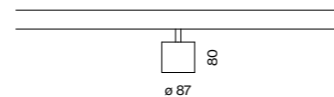

Colours



Light distributions



Order options

COLOUR TEMPERATURE	
3000K	0
4000K	1

CONTROL	
non DIM	1
DALI-2	3

MATERIAL COLOUR	
○ traffic white RAL 9016	7
● jet black RAL 9005	8

BEAM ANGLE	
spot 17°	S
medium 28°	M
flood 38°	F

Options on request

COLOUR RENDERING INDEX	
CRI ≥ 80	

CONTROL	
Casambi	

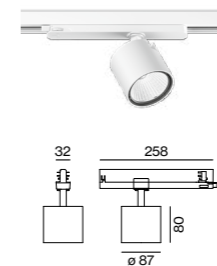

VARO 80 S track



TRACK LIGHT

SYSTEM POWER	LUMINOUS FLUX	ORDER CODE
28.5W	2600lm	180-6420::◆◆▲
45W	3610lm	180-6421::◆◆▲

Optical accessories

LENSES AND HONEYCOMB LOUVER

TYPE	Ø H (mm)	ORDER CODE
linear prismatic lens	75.9	080-6402110P
honeycomb louver	75.9	080-6401118

SNOOT

TYPE	Ø H (mm)	ORDER CODE
short	66.23	080-6403118
medium	66.38	080-6403218
angle	66.38	080-6403318

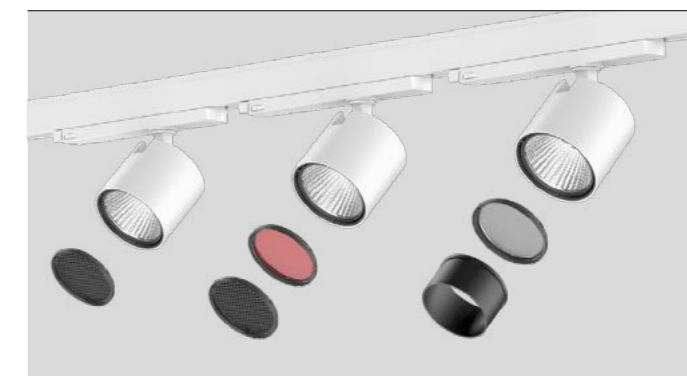
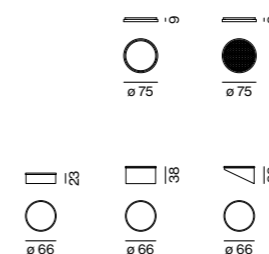

possibility to combine different optical accessories (max. 2 pieces)

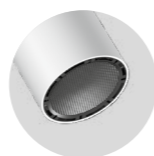

optical accessories



combine 2 optical accessories



355° rotatable, 90° tiltable

LUMINOUS FLUX value calculated for 3000K, CRI ≥ 90, colour white, flood 4000K +8%

s.Oliver Store Munich, DE –
by Kitzig Interior Design GmbH
including lighting design





Feucht Mode Innsbruck, AT –
by blocher partners with lighting design by
Hailight Lichtplanung, Andreas Haidegger



Museo Camera Gurugran, IN –
by Studio Lunitiv

back

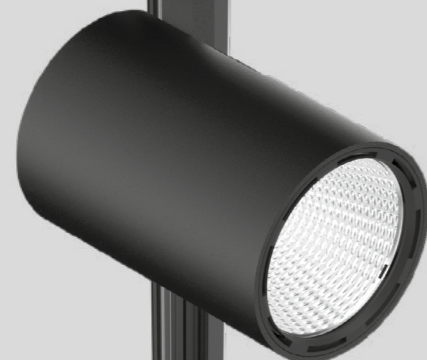

VARO 80/110

track

EN Track spotlight in die-cast aluminium, available in 2 different sizes; surface powder coated; spotlight head 355° rotatable and 90° tiltable; converter installed in aluminium spotlight housing; high quality reflector with spherical facet finish; precise radiation characteristics with different beam angles; installed and exchanged without tools; optical attachments as accessories; COB (Chip on Board) technology for maximum efficiency; no multiple shadows; energy-efficient LEDs with very good colour rendering; adapter for toolless insertion or movement on a variety of 3-phase power tracks

DE Stromschienenstrahler aus Aluminiumdruckguss in 2 verschiedenen Größen; Oberfläche pulverbeschichtet; Strahlerkopf 355° dreh- und 90° schwenkbar; Konverter im Strahlergehäuse aus Aluminium verbaut; hochwertiger Reflektor mit sphärischer Facettenoptik; präzise Abstrahlcharakteristik mit verschiedenen Ausstrahlwinkeln; werkzeuglos einsetz- bzw. austauschbar; optische Aufsätze als Zubehör; mit COB (Chip on Board) Technologie für höchste Effizienz; keine Bildung von Mehrfachschatten; energieeffiziente LEDs mit sehr guter Farbwiedergabe; Adapter für werkzeugloses Einsetzen bzw. Verschieben in verschiedenen 3-Phasen Stromschienen

Quickinfo

3000K, 4000K
CRI ≥ 90, 3 SDCM
VARO 80 up to 95lm/W
VARO 110 up to 100lm/W
L80/50 000h
non DIM

Types

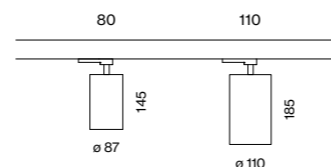

Colours



Light distributions



Order options

COLOUR TEMPERATURE	☼☼☼
3000K	5
4000K	6

CONTROL

non DIM

MATERIAL COLOUR

○ traffic white RAL 9016	7
● jet black RAL 9005	8

BEAM ANGLE

VARO 80	▲
spot 17°	S
medium 28°	M
flood 38°	F

BEAM ANGLE

VARO 110	▲
spot 14°	S
medium 24°	M
flood 33°	F

Options on request

COLOUR RENDERING INDEX
CRI ≥ 95 2-SDCM

SPECIAL COLOUR RENDERING

vogue	CRI ≥ 90
gallery	CRI 98
gourmet	CRI ≥ 80
fresh meat & fish	CRI ≥ 80
pastry	CRI ≥ 80
brilliant white	CRI ≥ 90

REFLECTOR

wide flood 67°
only for VARO 110



355° rotatable,
90° tiltable

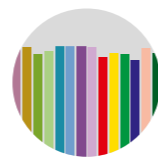

CRI ≥ 95
2 SDCM

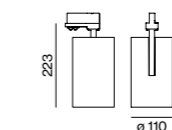
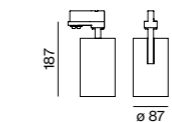

VARO 80 track

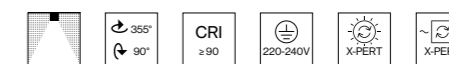

TRACK LIGHT

SYSTEM POWER	LUMINOUS FLUX	ORDER CODE
29 W	2700 lm	080-6210::1▲

VARO 110 track

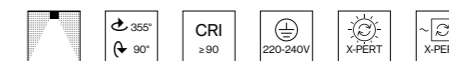

TRACK LIGHT

SYSTEM POWER	LUMINOUS FLUX	ORDER CODE
42 W	4210 lm	080-6120::1▲

Optical accessories

SNOOT WITH HONEYCOMB LOUVER

TYPE	Ø H (mm)	ORDER CODE
VARO 80	83-9	006-93120
VARO 110	106-9	006-93130

LUMINOUS FLUX value calculated for 3000K, CRI ≥ 90, colour white, flood 4000K +5%



Kastner & Öhler, Kaufhaus Tyrol Innsbruck, AT –
by DIOMA AG / WHIR3 / K&Ö Bauabteilung with
lighting design by VEDDER.LICHTMANAGEMENT



Porsche Studio Saigon, VN –
by Kobi Lighting Studio



Known for his expressive colours

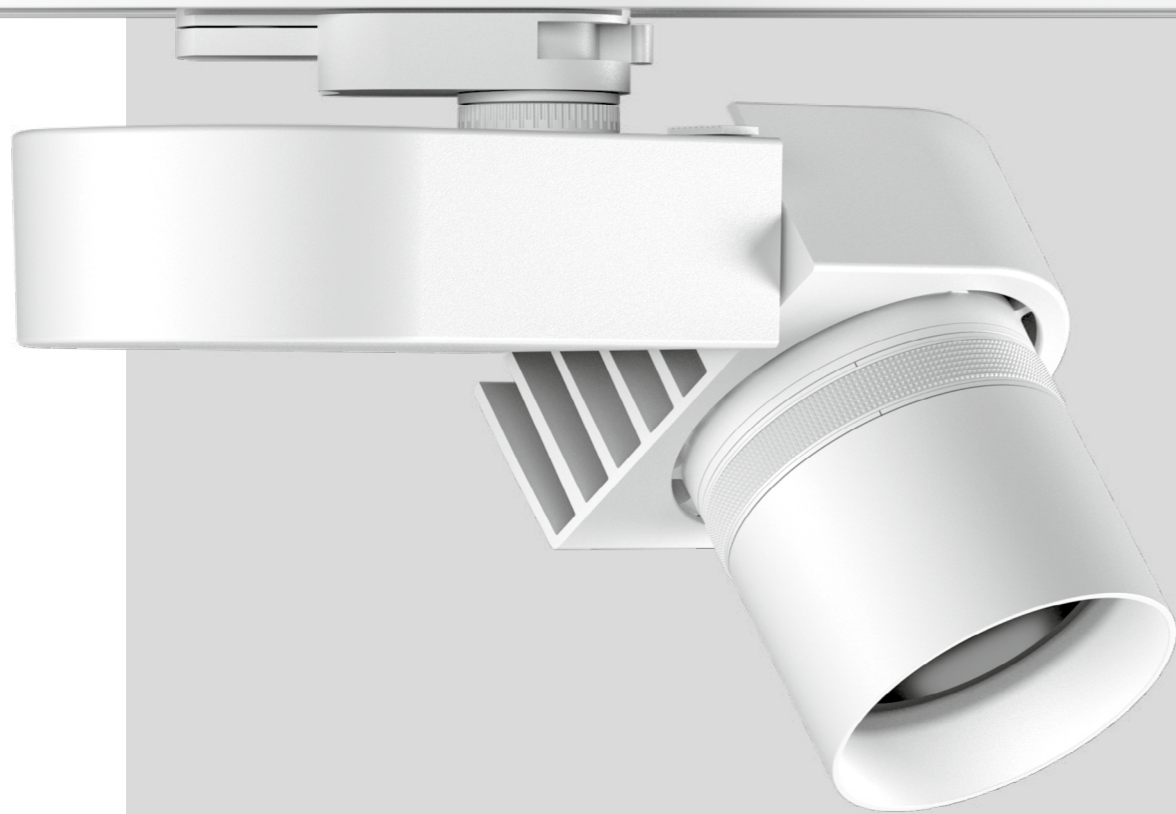

PABLO

EN The PABLO track-mounted spotlight was developed especially for museums. With a colour rendering index of up to $CRI \geq 95$, it illuminates works of art with near-perfect colour reproduction. The Colour Tune variant compensates for age-related colour changes in paintings with increased and customisable red-blue saturation. PABLO is fixed in the tracks without tools, and the spotlight heads can be rotated, swivelled, and repositioned almost at will. PABLO focus's beam angle is also adjustable. The iris, shutter, and gobo versions create sharp-edged light cut-outs in various shapes to stage works of art even more excitingly. The multilens version of PABLO has five attachment lenses that can be exchanged without tools depending on the required beam pattern. The mood of the room can be influenced by using the Tunable White version to change light colours.

DE Der Stromschieneenstrahler PABLO wurde speziell für Museen entwickelt. Mit einem Farbwiedergabeindex von bis zu $CRI \geq 95$ beleuchtet er Kunstwerke nahezu farbecht. In der Colour-Tune-Variante werden außerdem alterungsbedingte Farbveränderungen an Gemälden durch eine erhöhte, individuell einstellbare Rot-Blau-Sättigung kompensiert. PABLO wird werkzeuglos in den Schienen fixiert, die Strahlerköpfe lassen sich nahezu beliebig drehen, schwenken und neu positionieren. Bei PABLO Focus kann zusätzlich der Abstrahlwinkel variiert werden. Die Varianten Iris, Shutter und Gobo kreieren scharfkantige Lichtausschnitte in unterschiedlichen Formen, um Kunstwerke noch spannender zu inszenieren. Die Multilens-Ausführung von PABLO besitzt fünf Vorsatzlinsen, die je nach benötigter Abstrahlcharakteristik werkzeuglos ausgetauscht werden können. Durch veränderbare Lichtfarben als Tunable White Option kann zudem die Stimmung im Raum beeinflusst werden.

Types

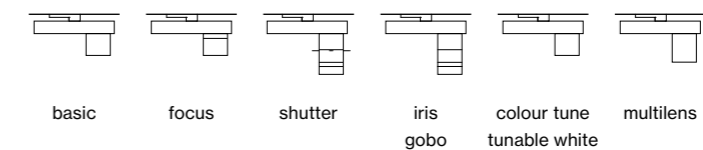

basic focus shutter iris gobo colour tune tunable white multilens

Mounting



track

Light distribution



spotlight

PABLO multilens

EN PABLO's multilens design lets the beam characteristics be flexibly adjusted depending on the application. For this purpose, there are five ancillary lenses that can be easily exchanged without tools. Objects are thus staged in the best possible light and the staging of a room with changing interiors becomes feasible.

DE Mit der PABLO Multilens-Ausführung kann die Abstrahlcharakteristik je nach Anwendung flexibel angepasst werden. Dafür gibt es fünf Vorsatzlinsen, die einfach werkzeuglos ausgetauscht werden können. So werden Objekte bestmöglich in Szene gesetzt und die Inszenierung des Raumes bei wechselndem Interieur wird ermöglicht.

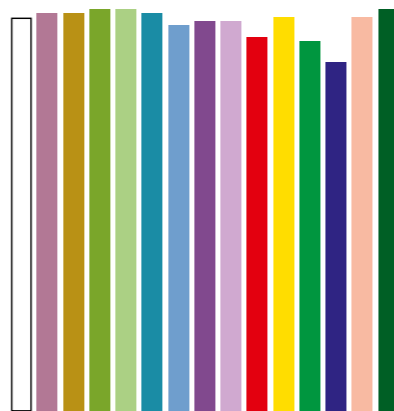

Authentic colours

EN Museum lighting must present exhibits authentically. PABLO illuminates works of art with near-perfect colour reproduction thanks to a colour rendering index of up to $CRI \geq 95$ and $R9 > 90$. Light colour and intensity can be controlled, allowing the lighting to be adapted to any new spatial setting.

DE Museumsbeleuchtung muss Exponate authentisch darstellen. Mit einem Farbwiedergabeindex von bis zu $CRI \geq 95$ und $R9 > 90$ beleuchtet PABLO Kunstwerke nahezu farbecht. Lichtfarbe und -intensität sind steuerbar, wodurch sich die Beleuchtung jeder neuen räumlichen Inszenierung anpassen lässt.

Light in form

EN PABLO's shutter, iris, and gobo variants create sharp-edged silhouettes in a square, round, or custom shape such as lettering. This means exhibits can be precisely custom-illuminated for maximum effect.

DE Die PABLO-Varianten Shutter, Iris und Gobo kreieren scharfkantige Silhouetten in viereckigen, runden oder individuell wählbaren Formen, wie z. B. Schriftzügen. Damit können Exponate exakt und zugeschnitten beleuchtet werden und maximal wirken.

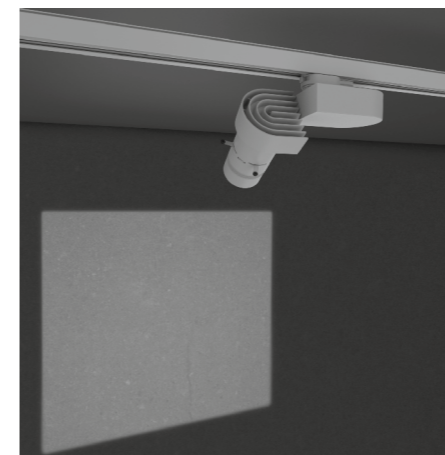

shutter

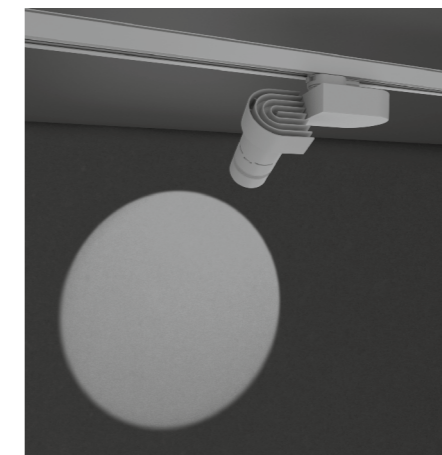

iris



gobo

Precise and variable

EN PABLO spots can be mounted and moved along the track without tools. The spotlight head can be fixed in any position without tools thanks to the special adapter fixing. This makes PABLO as precise as it is flexible, even after installation.

DE PABLO Spots lassen sich entlang der Stromschienen werkzeuglos montieren und verschieben. Dank der speziellen Adapterfixierung kann der Strahlerkopf werkzeuglos in jeder Position fixiert werden. Dadurch ist PABLO so präzise wie flexibel – auch nach seiner Installation.



Restored by light

EN PABLO Colour Tune was developed to faithfully revive historical art worthy of protection. A customisable red-blue saturation compensates, purely thanks to the lighting, for time-related colour damage. This gently reawakens a work of art's original colours.

DE Um historische und schützenswerte Kunst originalgetreu wiederzubeleben, wurde PABLO Colour Tune entwickelt. Eine individuell einstellbare Rot-Blau-Sättigung kompensiert zeitlich bedingte Farbschäden – rein durch die Beleuchtung. So werden die ursprünglichen Farben eines Kunstwerks schonend wiedererweckt.



Easy dimming

EN PABLO's DIM Poti variant has a manual dimming function. The brightness can be easily adjusted directly on-site at the spotlight head to suit the surroundings and the desired lighting mood.

DE In der DIM Poti-Variante verfügt PABLO über eine manuelle Dimmfunktion. So kann die Helligkeit einfach und direkt vor Ort am Strahlerkopf an ihre Umgebung und die gewünschte Lichtstimmung angepasst werden.

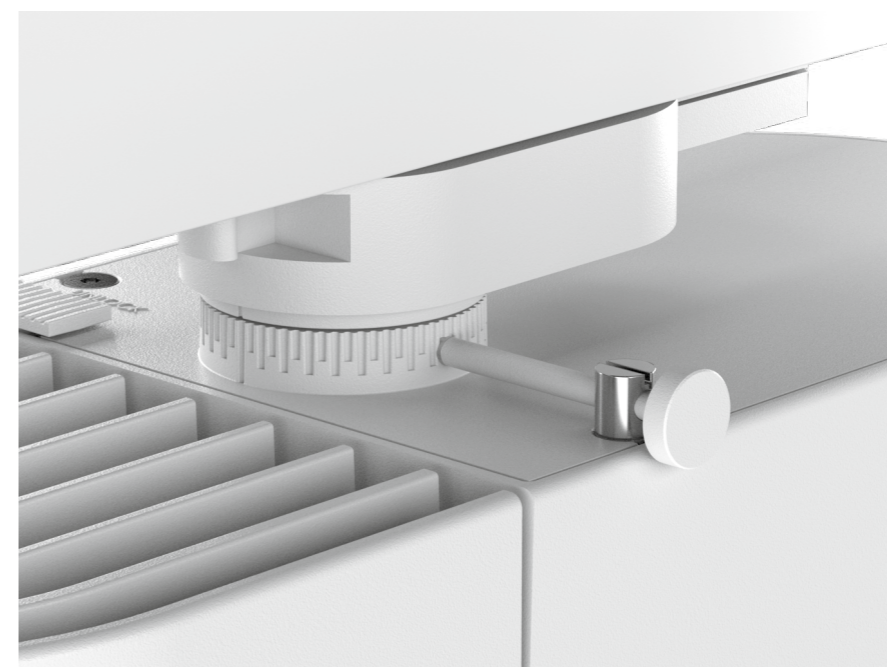

← back



PABLO basic/focus

track

EN Track light made of die-cast aluminium; powder coated; converter in spotlight housing; COB (Chip on Board) technology – maximum efficiency; no multiple shadows; energy-eff. LEDs – very good colour rendering; PABLO basic: sym./asym. radiation characteristic; PABLO focus: object focusing through adjustable lens; adjustable beam angle; PABLO shutter / iris: contour spotlight for rectangular or round shape – adjustment by 4 shading elements / by iris-shaped shade; toolless insertion or movement on a variety of 3-phase power tracks; adapter fixation optionally without tools by means of knurled screw or set screw (screwdriver required); point outlet, either in surface mounted housing or recessed housing, as an accessory

DE Stromschienenstrahler aus Aluminium-druckguss; pulverbeschichtet; Konverter im Strahlergehäuse; COB (Chip on Board) Technologie – höchste Effizienz; keine Mehrfachschatten; energieeff. LEDs – sehr gute Farbwiedergabe; PABLO basic: sym./asym. strahlend; PABLO focus: Objekt-Fokussierung durch justierbare Linse; Ausstrahlwinkel einstellbar; PABLO shutter / iris: Konturstrahler für rechteckige / runde Formgebung – Einstellung durch 4 Abschattenelemente / durch irisförmige Abschatter; werkzeugloses Einsetzen bzw. Verschieben in versch. 3-Phasen Stromschienen; Adapter-Fixierung wahlweise werkzeuglos mittels Rändel- oder Feststellschraube (Schraubendreher erforderlich); Punktauslass, wahlw. in Anbaugehäuse bzw. Einbaugehäuse, als Zubehör

Quickinfo

3000K, 4000K
CRI ≥ 95, 2 SDCM
POTI, DALI

L85 @ 50 000 h
PABLO basic up to 87lm/W
PABLO focus up to 69lm/W

L90 @ 50 000 h
PABLO shutter/iris up to 18lm/W

Types

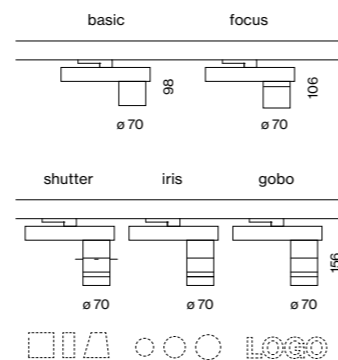

Colours



Light distributions

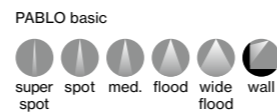

PABLO focus



DiiA® standards
251, 252, 253



360° rotatable
310° tilttable



DIM POTI/
rotation lock



shutter/iris/
gobo

Order options

ADAPTER FIXATION
tool-free fixation 2
set screw (tool required) 1

COLOUR TEMPERATURE
3000K 0
4000K 1

CONTROL
DIM POTI 8
DALI 3

MATERIAL COLOUR
○ traffic white RAL 9016 7
● jet black RAL 9005 8

REFLECTOR
super spot 6° (only for 11W) V
spot 12° S
medium 24° M
flood 39° F
wide flood 58° W
wallwasher A

Options on request

REFLECTOR
oval flood

Light distribution

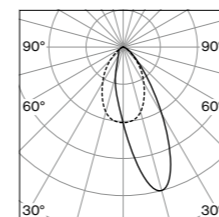

wallwasher

LUMINOUS FLUX value calculated for CRI ≥ 95, colour white, reflector spot



PABLO basic

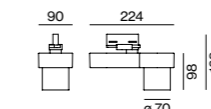

TRACK LIGHT

SYS. POWER	COLOUR TEMPERATURE	LUMINOUS FLUX	ORDER CODE
10.9 W (3-SDCM)	3000K (CRI ≥ 90)	614 lm	180-51005
	4000K (CRI ≥ 90)	660 lm	180-51006
13.9 W	3000K	986 lm	180-51000
	4000K	1080 lm	
22.9 W	3000K	1460 lm	180-51011
	4000K	1610 lm	



PABLO focus 17–47°



TRACK LIGHT

SYS. POWER	COLOUR TEMPERATURE	LUMINOUS FLUX	ORDER CODE
14 W	3000K	785 lm	180-52000
	4000K	862 lm	
23 W	3000K	1170 lm	180-52010
	4000K	1280 lm	

Optical accessories

SNOOT | HONEYCOMB LOUVER

TYPE	Ø H (mm)	ORDER CODE
snoot	62-33	080-590008
honeycomb louver	61-3	080-590018

Mounting accessories

SURFACE HOUSING/POINT OUTLET

TYPE	ORDER CODE
surface housing/point outlet	186-07228

RECESSED HOUSING/POINT OUTLET

ceiling thickness: 1-30 mm

TYPE	ORDER CODE
recessed housing/point outlet	186-07227



← back

Order options

ADAPTER FIXATION

tool-free fixation	2
set screw (tool required)	1

COLOUR TEMPERATURE

3000K	0
4000K	1

CONTROL

DIM POTI	8
DALI	3

MATERIAL COLOUR

○ traffic white RAL 9016	7
● jet black RAL 9005	8

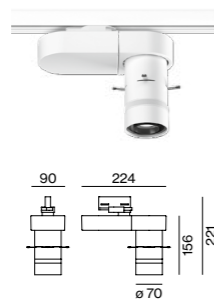

PABLO shutter



TRACK LIGHT

SYS. POWER	COLOUR TEMP.	LUMINOUS INTENSITY	ORDER CODE
14 W	3000K	854 cd	180-5300::
	4000K	934 cd	
23 W	3000K	1266 cd	180-5301::
	4000K	1389 cd	

illuminance (lux) = luminous intensity (cd)/distance (m)²

LIGHT DISTRIBUTION

possible shapes of illumination

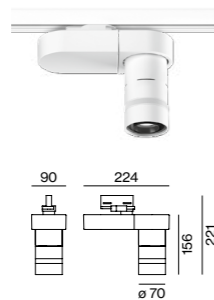
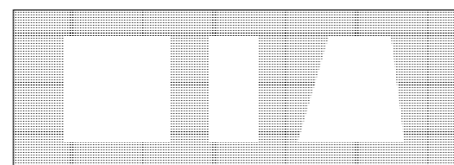

PABLO iris



TRACK LIGHT

SYS. POWER	COLOUR TEMP.	LUMINOUS INTENSITY	ORDER CODE
14 W	3000K	873 cd	180-5400::
	4000K	960 cd	
23 W	3000K	1297 cd	180-5401::
	4000K	1425 cd	

illuminance (lux) = luminous intensity (cd)/distance (m)²

LIGHT DISTRIBUTION

possible shapes of illumination

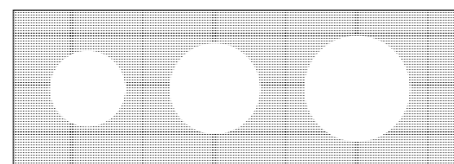

Illumination size

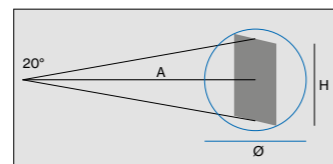

A (mm)	H (mm)	Ø (mm)
1000	396	560
2000	792	1120
3000	1188	1680

Order options

MATERIAL COLOUR

○ traffic white RAL 9016	7
● jet black RAL 9005	8

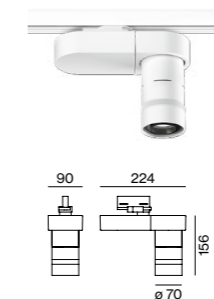

PABLO gobo



TRACK LIGHT

SYS. POWER	LUMINOUS INTENSITY	ORDER CODE
14 W	depends on form	on request

LIGHT DISTRIBUTION

customised shapes of illumination possible

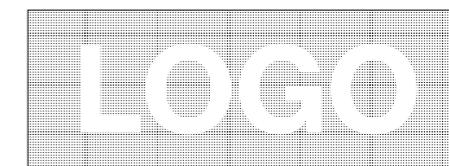

Mounting accessories



SURFACE HOUSING/POINT OUTLET

TYPE	ORDER CODE
surface housing/point outlet	186-07228



RECESSED HOUSING/POINT OUTLET

ceiling thickness: 1-30 mm

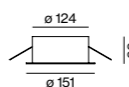

TYPE	ORDER CODE
recessed housing/point outlet	186-07227



Nationalmuseum Stockholm, SE –
 by Wingårdhs with lighting design
 by Gabriele von Kardorff



← back



PABLO colour tune/tunable white

track

EN Track light made of die-cast aluminium; powder coated; converter in spotlight housing; COB (Chip on Board) technology or CSP (Chip-Scale-Packaging) technology for maximum efficiency; no multiple shadows; energy-eff. LEDs – very good colour rendering; high quality aluminium refl., spherical facet finish; high-gloss anodised; precise radiation charact. – different beam angles; installed/exchanged without tools; optical attachments as accessories; adapter for toolless insertion or movement on a variety of 3-phase power tracks; adapter fixation optionally without tools by means of knurled screw or set screw (screwdriver required); point outlet, either in surface mounted housing or recessed housing, as an accessory

DE Stromschienenstrahler aus Aluminium-druckguss; pulverbeschichtet; Konverter im Strahlergehäuse; COB (Chip on Board) Technologie bzw. CSP (Chip-Scale-Packaging) Technologie für höchste Effizienz; keine Mehrfachschatten; energieeff. LEDs – sehr gute Farbwiedergabe; hochwert. Aluminium-refl., sphärische Facettenoptik; hochglänzend elox.; präzise Abstrahlcharakt. – verschied. Ausstrahlwinkel; werkzeuglos einsetz-/austauschbar; optische Aufsätze als Zubehör; Adapter für werkzeugloses Einsetzen bzw. Verschieben in verschiedenen 3-Phasen Stromschienen; Adapter-Fixierung wahlweise werkzeuglos mittels Rändel- oder Feststellschraube (Schraubendreher erforderlich); Punktauslass, wahlw. in Anbaugehäuse bzw. Einbaugehäuse, als Zubehör

Quickinfo

PABLO colour tune
3500 K red/blue
CRI ≥ 90, 3 SDCM
up to 54lm/W
L95 @ 50 000h
DALI-2

PABLO tunable white
TW 2700–5000K
CRI ≥ 95, 3 SDCM
up to 48lm/W
L80 @ 50 000h
DALI-2 DT8

Type

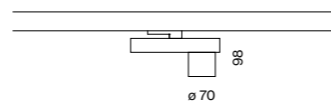

Colours



Light distributions

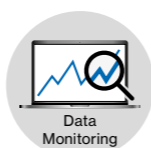

DiiA® standards
251, 252, 253



360° rotatable
245°/65° tiltable



rotation
lock



colour tune
(3500K red/blue)

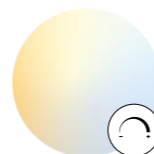

tunable white
2700–5000K

Order options

ADAPTER FIXATION
tool-free fixation 2
set screw (tool required) 1

MATERIAL COLOUR
○ traffic white RAL 9016 7
● jet black RAL 9005 8

BEAM ANGLE
medium 20/24° M
flood 38° F

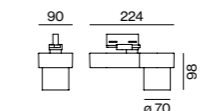

PABLO colour tune



TRACK LIGHT

SYS. POWER	COLOUR TEMPERATURE	LUMINOUS FLUX	ORDER CODE
18.8 W	3500K red/blue	1020 lm	180-5600G3

Fresh colour for historical works of art



PABLO colour tune was developed to revitalise historical art, which is particularly worthy of protection, true to the original. An increased, individually adjustable red-blue saturation compensates for time-related colour damage – purely through the lighting. This reawakens the original colours of a work of art. The correct setting of PABLO colour tune can be easily controlled and adjusted via DALI-2.

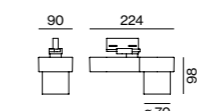

PABLO tunable white



TRACK LIGHT

SYS. POWER	COLOUR TEMPERATURE	LUMINOUS FLUX	ORDER CODE
20.7 W	2700–5000K	954 lm	180-5600D3

Optical accessories

SNOOT | HONEYCOMB LOUVER

TYPE	Ø-H (mm)	ORDER CODE
snoot	62-33	080-5900008
honeycomb louver	61-3	080-5900018

Mounting accessories

SURFACE HOUSING/POINT OUTLET

TYPE	ORDER CODE
surface housing/point outlet	186-07228

RECESSED HOUSING/POINT OUTLET

ceiling thickness: 1-30 mm

TYPE	ORDER CODE
recessed housing/point outlet	186-07227



LUMINOUS FLUX value calculated for colour white, reflector medium

Nationalmuseum Stockholm, SE –
by Wingårdhs with lighting design
by Gabriele von Kardorff



back



PABLO multilens

track

EN Track light made of die-cast aluminium; powder coated; 360° rotatable and 310° tiltable; converter installed in aluminium spotlight housing; COB (Chip on Board) technology for maximum efficiency; no multiple shadows; energy-eff. LEDs – very good colour rendering; exchangeable additional lenses; precise radiation characteristics with different beam angles; installed and exchanged without tools; optical attachments as accessories; adapter for toolless insertion or movement on a variety of 3-phase power tracks; adapter fixation optionally without tools by means of knurled screw or set screw (screwdriver required); point outlet, either in surface mounted housing or recessed housing, as an accessory

DE Stromschienenstrahler aus Aluminiumdruckguss; pulverbeschichtet; 360° dreh- und 310° schwenkbar; Konverter im Strahlergehäuse aus Aluminium verbaut; mit COB (Chip on Board) Technologie für höchste Effizienz; keine Mehrfachschatten; energieeff. LEDs – sehr gute Farbwiedergabe; austauschbare Vorsatzlinsen; präzise Abstrahlcharakteristik mit verschiedenen Ausstrahlwinkeln; werkzeuglos einsetz- bzw. austauschbar; optische Aufsätze als Zubehör; Adapter für werkzeugloses Einsetzen bzw. Verschieben in verschiedenen 3-Phasen Stromschienen; Adapter-Fixierung wahlweise werkzeuglos mittels Rändel- oder Feststellschraube (Schraubendreher erforderlich); Punktauslass, wahlweise in Anbaugehäuse bzw. Einbaugehäuse, als Zubehör

Quickinfo

3000K, 4000K
CRI ≥ 90, 2 SDCM
up 76lm/W
L85 @ 50 000h
DIM POTI

Type



Colours



Light distributions



Order options

ADAPTER FIXATION
tool-free fixation 2
set screw (tool required) 1

COLOUR TEMPERATURE
3000K 5
4000K 6

CONTROL

DIM POTI

MATERIAL COLOUR

traffic white RAL 9016 7
 jet black RAL 9005 8

BEAM ANGLE

10/19/30/38/40/64°

Options on request

CONTROL

DALI-2

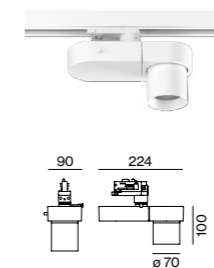

PABLO multilens 10–60°



TRACK LIGHT

SYS. POWER	COLOUR TEMPERATURE	LUMINOUS FLUX	ORDER CODE
14.8W	3000K	1050lm	180-57008
	4000K	1130lm	

incl. 5 pcs. interchangeable diffusion sheets

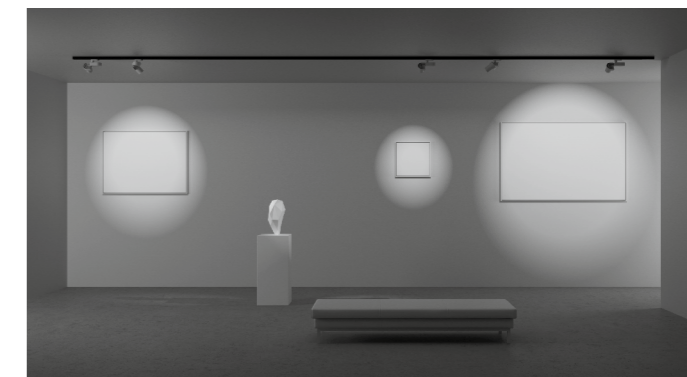

Optical accessories

OVAL FILTER

TYPE	ORDER CODE
oval filter 60 × 15°	080-5900020
diffusion sheet for superspot*	080-5900030

*for a better homogeneous illumination

Mounting accessories

SURFACE HOUSING/POINT OUTLET

TYPE	ORDER CODE
surface housing/point outlet	186-07228

RECESSED HOUSING/POINT OUTLET

ceiling thickness: 1-30 mm

TYPE	ORDER CODE
recessed housing/point outlet	186-07227

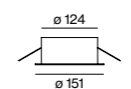
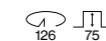

DiiA® standards
251, 252, 253

interchangeable
diffusion sheets360° rotatable
310° tiltableDIM POTI/
rotation lock

LUMINOUS FLUX value calculated for
CRI ≥ 90, colour white, lens spot

Free to arrange

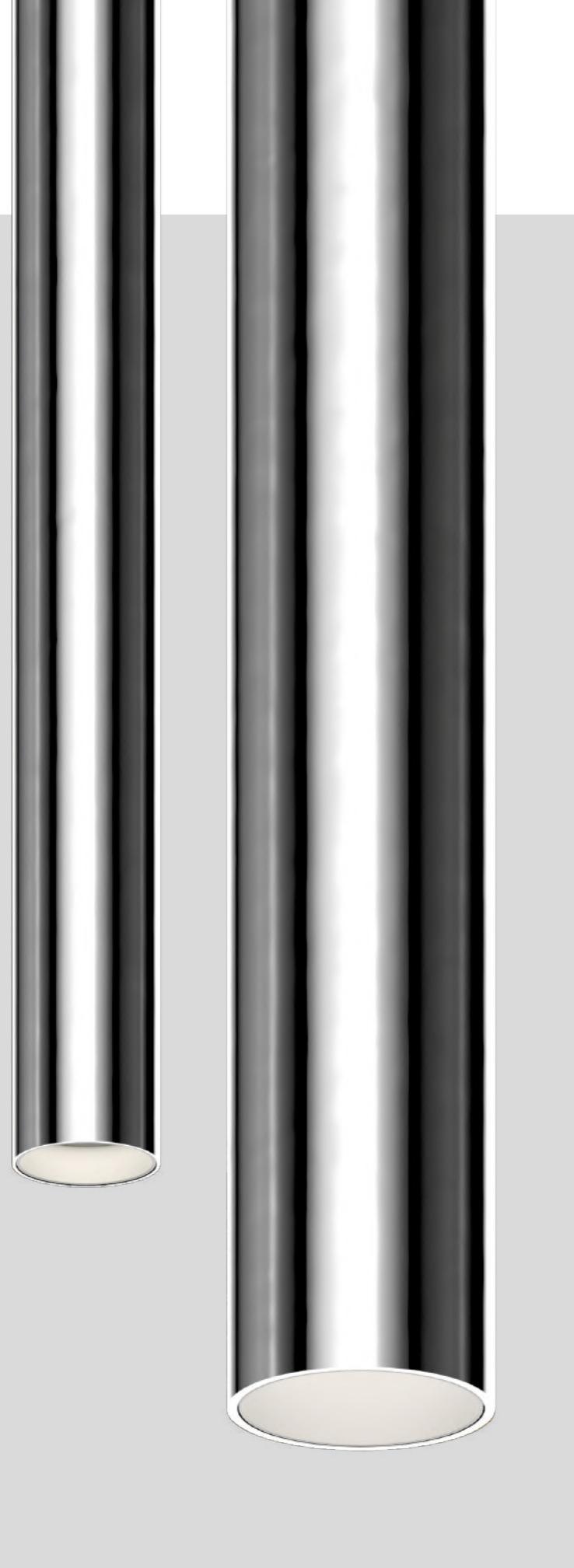

TULA

EN A suspended luminaire that gives more than “just” light. TULA immediately catches the eye with its decorative, slim shape. The luminaire is available in white, black, and chrome, as well as in numerous custom colours. Depending on your interior design, choose between the light colours 2700K, 3000K, or 4000K. The position of the luminaires can be easily changed with additional hooks on the cable and rings on the ceiling, thus TULA always adapts itself to evolving conditions in the space or creates artistic patterns. TULA is also available as a lighting inset for the MOVE IT track system.

DE Eine Pendelleuchte, die mehr als „nur“ Licht gibt. Durch ihre dekorative, schlanke Form fällt TULA sofort auf. Die Leuchte ist in Weiß, Schwarz und Chrom sowie in zahlreichen Sonderfarben erhältlich. Je nach Interior Design können Sie zwischen den Lichtfarben 2700K, 3000K oder 4000K wählen. Mit zusätzlichen Haken am Kabel und Ringen an der Decke wird die Position der Leuchte einfach verändert – so passt sie sich stets neuen Gegebenheiten im Raum an oder kreiert kunstvolle Muster. TULA ist auch als Lichteinsatz für das MOVE IT Stromschienensystem verfügbar.

Types



25
nano

45
micro

Mounting



suspended

Light distribution

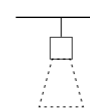

downlight

← back



TULA

suspended

EN Decorative suspended luminaire in aluminium; surface polished chrome or powder coated; pendant fitting with suspension, incl. feed (black or white); can be individually shortened; good glare reduction due to recessed light point plane; incl. high quality lens system; COB (Chip on Board) technology or high power LEDs for maximum efficiency; no multiple shadows; energy-efficient LEDs with very good colour rendering; canopy for through wiring; converter included in canopy, either recessed or surface mounted version; ceiling mounting rings for multiple positioning of the luminaire in the room available as accessory

DE Dekorative Pendelleuchte aus Aluminium; Oberfläche chrom poliert oder pulverbeschichtet; abgependelt mit Pendelabhängung, inkl. Einspeiseleitung (schwarz oder weiß); beliebig kürzbar; gute Entblendung durch zurückversetzte Lichtpunktebene; inkl. hochwertiger Linsenoptik; mit COB (Chip on Board) Technologie bzw. High-Power-LEDs für höchste Effizienz; keine Mehrfachschatten; energieeffiziente LEDs mit sehr guter Farbwiedergabe; Baldachin für Weiterverdrahtung; Konverter im Baldachin enthalten, wahlweise als Einbau- oder Anbauvariante; Deckenmontageringe für multiple Positionierung der Leuchte im Raum als Zubehör erhältlich

Quickinfo

2700 K, 3000 K
 CRI ≥ 90, 3 SDCM
 up to 95 lm/W
 L80 @ 50 000 h
 non DIM, DALI-2, Casambi

Types

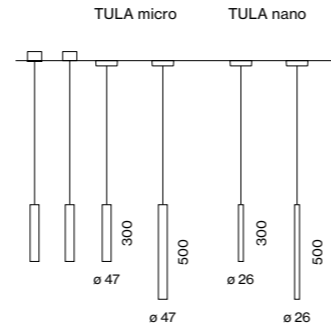

Colours



Light distributions



Order options

HOUSING HEIGHT	
300 mm	5
500 mm	7

SUSPENSION	
cable 1500 mm	

COLOUR TEMPERATURE	
2700 K	4
3000 K	5

MATERIAL COLOUR	
chrome	4
traffic white RAL 9016	7
jet black RAL 9005	8
special colours* p. 992	X

*cable always in white

BEAM ANGLE	
medium 25°	M
flood 44°	F

ACCESSORY COLOUR	
traffic white RAL 9016	7
jet black RAL 9005	8

Options on request

COLOUR TEMPERATURE	
4000 K	

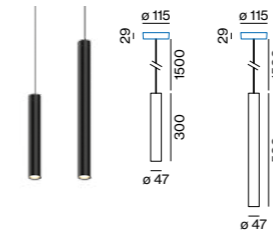
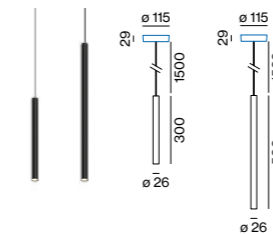

TULA nano suspended

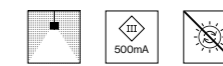

INSET POWER	LUMINOUS FLUX	ORDER CODE
9W 18 Vf 500mA	732lm	0 49-5 L 10 :: 1

TULA micro suspended

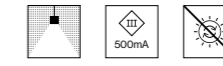

INSET POWER	LUMINOUS FLUX	ORDER CODE
8.4W 18 Vf 500mA	798lm	0 49-5 L 15 :: 1

Mounting accessories

CANOPY CEILING 220-240V AC, 50-60Hz, PC I

TYPE	EFFICIENCY	Ø-H (mm)	ORDER CODE
500 mA non DIM	η 79 %	115-29	0 05-260211
500 mA DALI-2	η 81 %	115-29	0 05-260213
500 mA Casambi	η 80 %	115-29	0 05-260219

MOUNTING SET RECESSED WITH TRIM

for installation in ceilings from 2-25 mm

TYPE	Ø-H (mm)	ORDER CODE
mounting set with trim	77-49	0 05-352101

MOUNTING SET RECESSED TRIMLESS

for installation in plasterboard ceilings 9-25 mm

TYPE	Ø-H (mm)	ORDER CODE
mounting set trimless	75-48	0 05-3511017

SPECIAL MOUNTING TOOL

TYPE	Ø-H (mm)	ORDER CODE
special mounting tool	100-9	0 63-8912110

necessary to install mounting set trimless

RING

TYPE	Ø-H (mm)	ORDER CODE
ceiling mounted	50-88	0 50-051021

HOOK

TYPE	L-W-H (mm)	ORDER CODE
ceiling mounted	18-13-58	0 50-590111

Electrical accessories

POWER SUPPLY 220-240V AC, 50-60Hz, PC II

TYPE	EFFICIENCY	L-W-H (mm)	ORDER CODE
500 mA non DIM	η 80 %	65-39-20	0 02-90732
500 mA DALI-2	η 82 %	147-33-23	0 02-90733

DIN RAIL COMPONENTS

TYPE	W-H-D (mm)	ORDER CODE
POWER SUPPLY 220-240V AC 96W 48V DC constant voltage	90-90-60	0 05-6520210
LED DRIVER DALI-2 DT6 1-2 addr. 200-1050 mA settable const. current 2x42W 48V DC U _{OUT} 10-40V	36-88-59	0 05-6121030

for more details and components see page 981

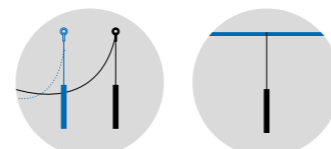

free positioning by ring and hook track version available (p. 742)

INSET POWER is the current consumption excluding any ballast
 LUMINOUS FLUX value calculated for 3000 K, CRI ≥ 90, colour white, lens flood 2700 K -5%



Casino Dusseldorf, DE –
by ttsp hwp seidel Planungsgesellschaft mbH
with lighting design by Licht Kunst Licht AG



Global Timber Århus, DK –
by RAVN architects with lighting
design by Rikke Sølvsteen



Arrange the mood

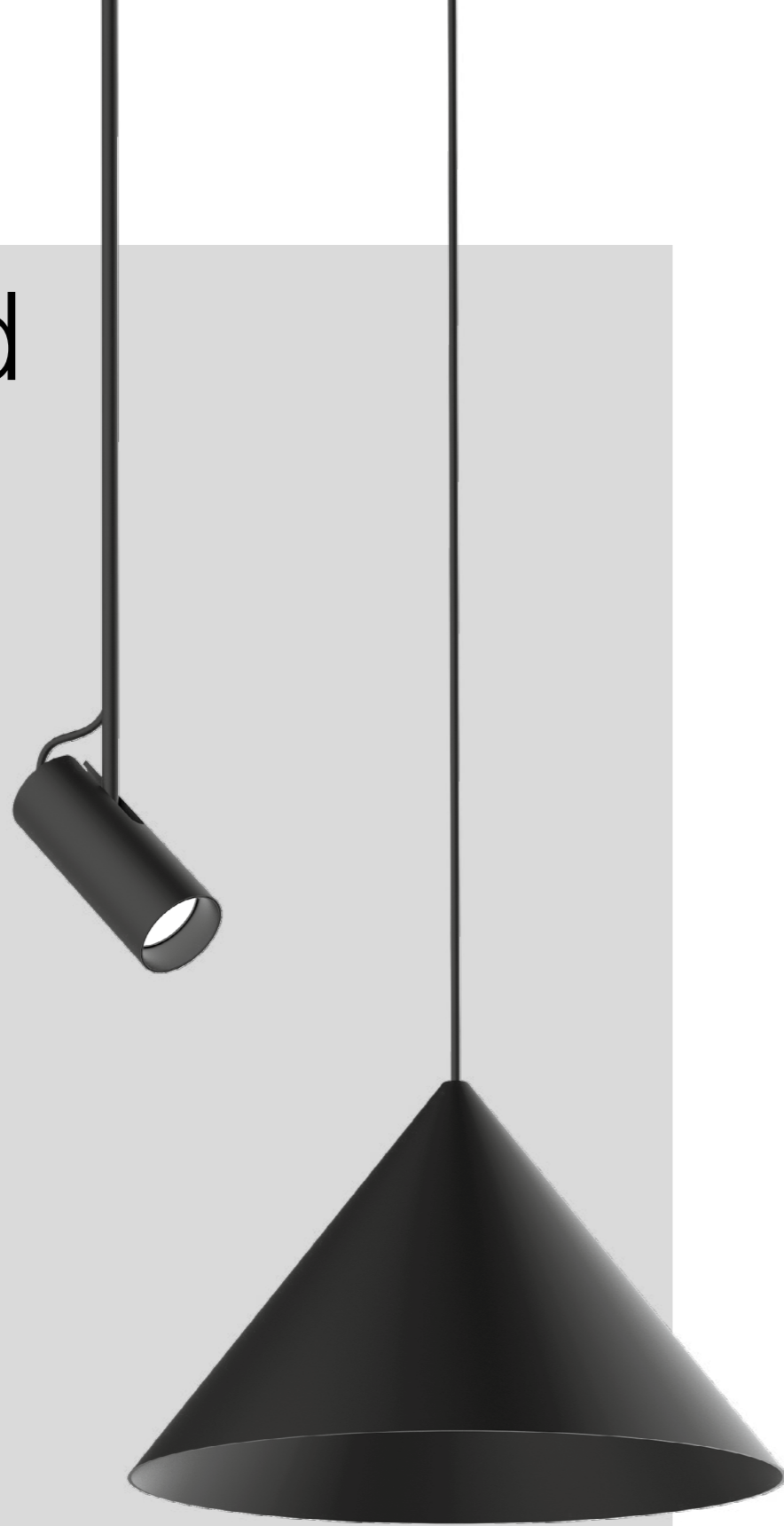

ARY

EN ARY simultaneously serves lighting and decor. The suspended spotlight luminaire amazes with various selectable beam characteristics and excellent colour rendering ($CRI \geq 90$). ARY's adjustable rod variant is maximally mobile. The spotlight head can be turned by 320° and tilted by 90° . The cable variant offers a choice of different shades to match the colour and size perfectly to your interior design. Separate ceiling rings create even more design freedom. The lights can be repositioned at will and grouped into exciting arrangements using the hooks. ARY is also available as a light inset for the elegant MOVE IT track system.

DE ARY ist Beleuchtung und Dekorationsobjekt zugleich. Die abgehängte Strahlerleuchte besticht durch unterschiedlich wählbare Abstrahlcharakteristiken und sehr gute Farbwiedergabe ($CRI \geq 90$). In der Adjustable-Rod-Variante ist ARY maximal beweglich: der Strahlerkopf kann um 320° gedreht und um 90° geschwenkt werden. Für die Kabelvariante haben Sie eine Auswahl an verschiedenen Shades, um Farbe und Größe perfekt auf Ihre Innenarchitektur abzustimmen. Separate Deckenringe schaffen noch mehr Gestaltungsfreiheit: Mittels Haken können die Leuchten immer wieder neu positioniert und zu spannenden Arrangements gruppiert werden. ARY ist auch als Lichteinsatz für das elegante MOVE IT Stromschienensystem verfügbar.

Types

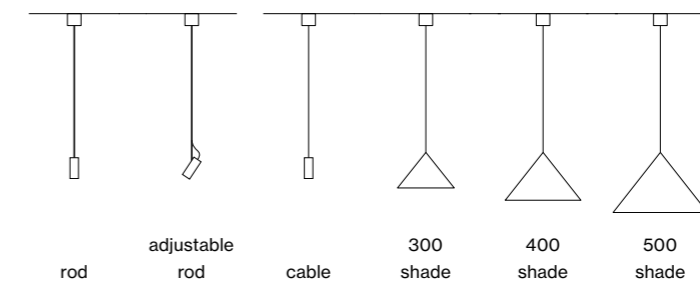

Mounting

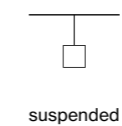

suspended

Light distributions

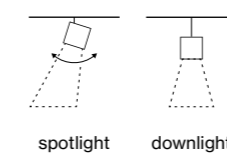

spotlight

downlight

← back

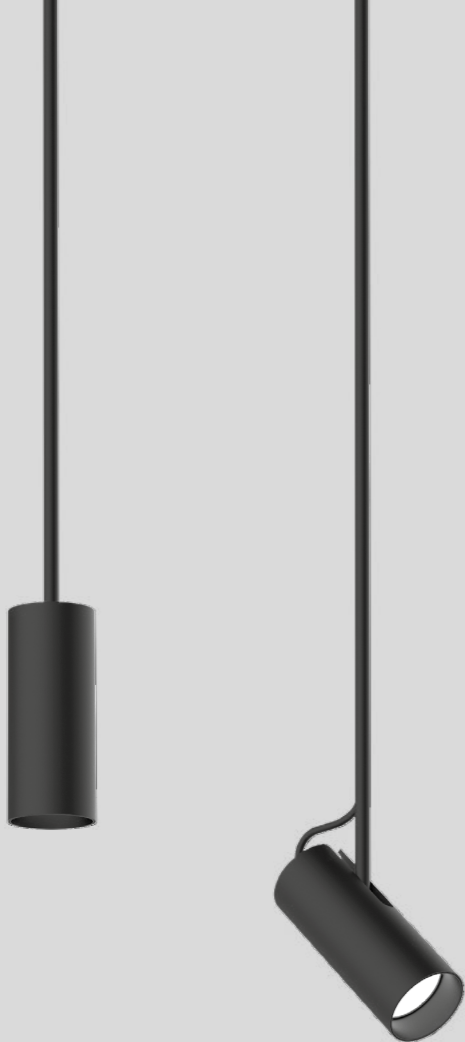

Quickinfo

2700 K, 3000 K, 4000 K
 CRI ≥ 90, 3 SDCM
 up to 95 lm/W
 L90 @ 50 000 h
 non DIM, DALI-2, Casambi

Types

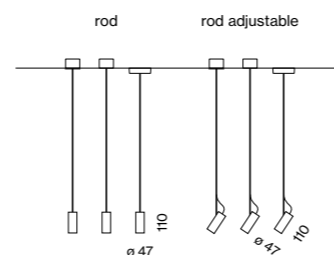

Colours



Light distributions



Order options

MOUNTING
 suspension 1500 mm 1
 suspension 2000 mm with hook* 2
 *one ring included

COLOUR TEMPERATURE
 2700 K 4
 3000 K 5
 4000 K 6

MATERIAL COLOUR
 ○ traffic white RAL 9016 7
 ● jet black RAL 9005 8
 ● special colours* p. 992 X
 *rod always in white

ACCESSORY COLOUR
 ○ traffic white RAL 9016 7
 ● jet black RAL 9005 8

BEAM ANGLE
 medium 25° M
 flood 44° F

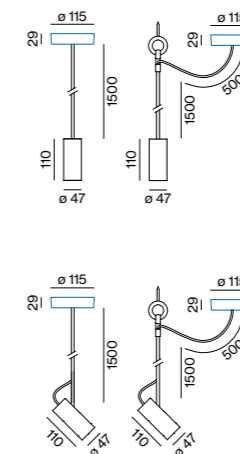

ARY rod suspended



DOWNLIGHT
INSET POWER 8.4 W 18 Vf 500 mA
LUMINOUS FLUX 791 lm
ORDER CODE 0 4 9 - 5 2 1 :: 1

ARY adjustable rod suspended



SPOTLIGHT ADJUSTABLE
INSET POWER 8.4 W 18 Vf 500 mA
LUMINOUS FLUX 791 lm
ORDER CODE 0 4 9 - 5 3 1 :: 1

Mounting accessories



TYPE	EFFICIENCY	Ø-H (mm)	ORDER CODE
500 mA non DIM	η 79 %	115-29	0 0 5 - 2 6 0 1 1 1
500 mA DALI-2	η 81 %	115-29	0 0 5 - 2 6 0 1 1 3
500 mA Casambi	η 80 %	115-29	0 0 5 - 2 6 0 1 1 9

use for suspension with rod



TYPE	EFFICIENCY	Ø-H (mm)	ORDER CODE
500 mA non DIM	η 79 %	115-29	0 0 5 - 2 6 0 2 1 1
500 mA DALI-2	η 81 %	115-29	0 0 5 - 2 6 0 2 1 3
500 mA Casambi	η 80 %	115-29	0 0 5 - 2 6 0 2 1 9

use for suspension with hook

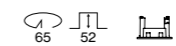

MOUNTING SET WITH TRIM for installation in ceilings from 2-25 mm

TYPE	Ø-H (mm)	ORDER CODE
single luminaire rod	77-49	0 0 5 - 3 5 2 2 0 1
single luminaire cable*	77-49	0 0 5 - 3 5 2 1 0 1

*use for suspension with hook

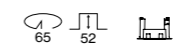

MOUNTING SET TRIMLESS for installation in plasterboard ceilings 9-25 mm

TYPE	Ø-H (mm)	ORDER CODE
single luminaire rod	75-48	0 0 5 - 3 5 1 2 0 1 7
single luminaire cable*	75-48	0 0 5 - 3 5 1 1 0 1 7

*use for suspension with hook



SPECIAL MOUNTING TOOL

TYPE	Ø-H (mm)	ORDER CODE
special mounting tool	100-9	0 6 3 - 8 9 1 2 1 1 0

necessary to install mounting set trimless



RING

TYPE	Ø-H (mm)	ORDER CODE
ceiling mounted	50-88	0 5 0 - 0 5 1 0 2 1

Electrical accessories

POWER SUPPLY 220-240V AC, 50-60 Hz,

TYPE	EFFICIENCY	L-W-H (mm)	ORDER CODE
500 mA non DIM	η 80 %	65-39-20	0 0 2 - 9 0 7 3 2
500 mA DALI-2	η 82 %	147-33-23	0 0 2 - 9 0 7 3 3

DIN RAIL COMPONENTS

TYPE	W-H-D (mm)	ORDER CODE
POWER SUPPLY 220-240 V AC 96 W 48V DC constant voltage	90-90-60	0 0 5 - 6 5 2 0 2 1 0
LED DRIVER DALI-2 DT6 1-2 addr. 200-1050 mA settable const. current 2x42W 48V DC U _{OUT} 10-40V	36-88-59	0 0 5 - 6 1 2 1 0 3 0

for more details and components see page 981



ARY rod

suspended

EN Decorative suspended luminaire in aluminium; surface powder coated; height adjustable U-profile pendant rod suspension (black or white), feed in U-profile; spotlight head either fixed or 320° rotatable and 90° tiltable; good glare reduction due to recessed light point plane; incl. high quality lens system; precise radiation characteristics with different beam angles; COB (Chip on Board) technology for maximum efficiency; no multiple shadows; energy-efficient LEDs with very good colour rendering; canopy for through wiring; converter included in canopy; ceiling mounting rings for multiple positioning of the luminaire in the room available as accessory

DE Dekorative Pendelleuchte aus Aluminium; Oberfläche pulverbeschichtet; kürzbare U-Profil-Pendelstangenabhangung (schwarz oder weiß), Einspeiseleitung in U-Profil; Strahlerkopf wahlweise starr bzw. 320° dreh- und 90° schwenkbar; gute Entblendung durch zurückversetzte Lichtpunktebene; inkl. hochwertiger Linsenoptik; präzise Abstrahlcharakteristik mit verschiedenen Ausstrahlwinkeln; mit COB (Chip on Board) Technologie für höchste Effizienz; keine Mehrfachschatten; energieeffiziente LEDs mit sehr guter Farbwiedergabe; Baldachin für Weiterverdrahtung; Konverter im Baldachin enthalten; Deckenmontageringe für multiple Positionierung der Leuchte im Raum als Zubehör erhältlich



320° rotatable, 90° tiltable

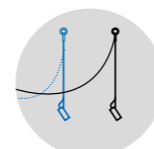

free positioning by ring and hook

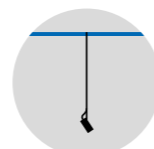

track version available (p. 734)

INSET POWER is the current consumption excluding any ballast
LUMINOUS FLUX value calculated for 3000 K, CRI ≥ 90, colour white, lens flood 2700 K -5%, 4000 K +5%

Restaurant Le Prestine Antwerp, BE –
by Space Copenhagen
with lighting design by anker & co





Restaurant Vinea Oldenburg, DE –
 by neun grad architektur with lighting design
 by CapitalReal Immobilien GmbH & Co. KG, Dennis Poelmeyer





ARY cable

suspended

EN Decorative suspended luminaire in aluminium; surface powder coated; pendant fitting with suspension, incl. feed (black or white); can be individually shortened; good glare reduction due to recessed light point plane; high quality lens system; precise radiation characteristics with different beam angles; shades as accessory in RAL colours velvet beige, madeira brown, kingfisher grey, woodpecker olive, signal white or signal black; COB (Chip on Board) technology for maximum efficiency; no multiple shadows; efficient LEDs with very good colour rendering; canopy for through wiring; converter included in canopy; ceiling mounting rings for multiple positioning of the luminaire in the room available as accessory

DE Dekorative Pendelleuchte aus Aluminium; Oberfläche pulverbeschichtet; abgependelt mit Pendelabhängung, inkl. Einspeiseleitung (schwarz oder weiß); beliebig kürzbar; gute Entblendung durch zurückversetzte Lichtpunktenebene; hochwertige Linsenoptik; präzise Abstrahlcharakteristik mit verschiedenen Ausstrahlwinkeln; Shades in den RAL Farben velvet beige, madeira brown, kingfisher grey, woodpecker olive, signal white oder signal black als Zubehör; COB (Chip on Board) Technologie für höchste Effizienz; keine Mehrfachschatten; effiziente LEDs mit sehr guter Farbwiedergabe; Baldachin für Weiterverdrahtung; Konverter im Baldachin enthalten; Deckenmontageringe für multiple Positionierung der Leuchte im Raum als Zubehör erhältlich

Quickinfo

2700 K, 3000 K, 4000 K
 CRI ≥ 90, 3 SDCM
 up to 95 lm/W
 L90 @ 50 000 h
 non DIM, DALI-2, Casambi

Types

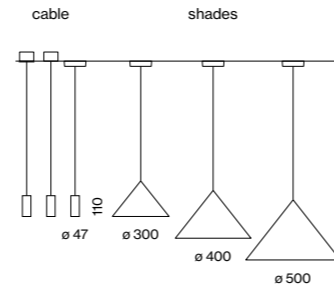

Colours



Light distributions



Order options

MOUNTING

suspension 1500 mm	1
suspension 2000 mm with hook* 2	2

*one ring included

COLOUR TEMPERATURE

2700 K	4
3000 K	5
4000 K	6

MATERIAL COLOUR

○ traffic white RAL 9016	7
● jet black RAL 9005	8
● special colours* p. 992	X

*cable always in white

SHADE COLOUR

● velvet beige RAL 085 80 10	C
● madeira brown RAL 050 40 40	T
● kingfisher grey RAL 230 60 10	L
● woodpecker olive RAL 10 50 20	G
○ signal white RAL 9003	W
● signal black RAL 9004	B

ACCESSORY COLOUR

○ traffic white RAL 9016	7
● jet black RAL 9005	8

BEAM ANGLE

medium 25°	M
flood 44°	F

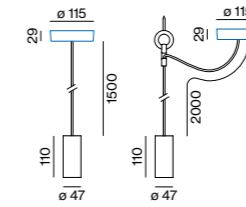
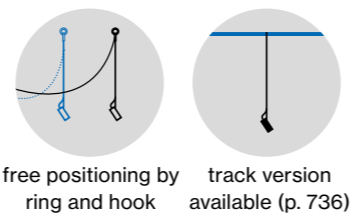

ARY cable suspended

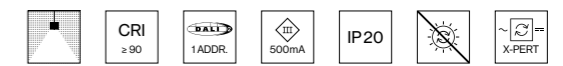

DOWNLIGHT

INSET POWER	LUMINOUS FLUX	ORDER CODE
8.4 W 18 Vf 500mA	791lm	0 4 9 - 5 1 1 1 1 1 1 1 1

Optical accessories

SHADE

TYPE	Ø-H (mm)	ORDER CODE
cone 300	300-188	0 4 9 - 5 9 3 3 1 1 1
cone 400	400-253	0 4 9 - 5 9 3 4 1 1 1
cone 500	500-318	0 4 9 - 5 9 3 5 1 1 1

Mounting accessories

CANOPY CEILING 220-240V AC, 50-60Hz, PC I

TYPE	EFFICIENCY	Ø-H (mm)	ORDER CODE
500 mA non DIM	η 79 %	115-29	0 0 5 - 2 6 0 2 1 1 1
500 mA DALI-2	η 81 %	115-29	0 0 5 - 2 6 0 2 1 3 1
500 mA Casambi	η 80 %	115-29	0 0 5 - 2 6 0 2 1 9 1

MOUNTING SET RECESSED WITH TRIM
 for installation in ceilings from 2-25 mm

TYPE	Ø-H (mm)	ORDER CODE
mounting set with trim	77-49	0 0 5 - 3 5 2 1 0 1 1

MOUNTING SET RECESSED TRIMLESS
 for installation in plasterboard ceilings 9-25 mm

TYPE	Ø-H (mm)	ORDER CODE
mounting set trimless	75-48	0 0 5 - 3 5 1 1 0 1 7

SPECIAL MOUNTING TOOL

TYPE	Ø-H (mm)	ORDER CODE
special mounting tool	100-9	0 6 3 - 8 9 1 2 1 1 0

necessary to install mounting set trimless

RING

TYPE	Ø-H (mm)	ORDER CODE
ceiling mounted	50-88	0 5 0 - 0 5 1 0 2 1 1

Electrical accessories

POWER SUPPLY 220-240V AC, 50-60Hz, PC II

TYPE	EFFICIENCY	L-W-H (mm)	ORDER CODE
500 mA non DIM	η 80 %	65-39-20	0 0 2 - 9 0 7 3 2
500 mA DALI-2	η 82 %	147-33-23	0 0 2 - 9 0 7 3 3

DIN RAIL COMPONENTS

TYPE	W-H-D (mm)	ORDER CODE
POWER SUPPLY 220-240 V AC 96W 48V DC constant voltage	90-90-60	0 0 5 - 6 5 2 0 2 1 0
LED DRIVER DALI-2 DT6 1-2 addr. 200-1050mA settable const. current 2x42W 48V DC U _{OUT} 10-40V	36-88-59	0 0 5 - 6 1 2 1 0 3 0

for more details and components see page 981

INSET POWER is the current consumption excluding any ballast
LUMINOUS FLUX value calculated for 3000 K, CRI ≥ 90, colour white, lens flood 2700 K -5%, 4000 K +5%

Colliers Real-estate Copenhagen, DK –
by Architect Helle Nøhr with lighting
design by anker & co



Get on track

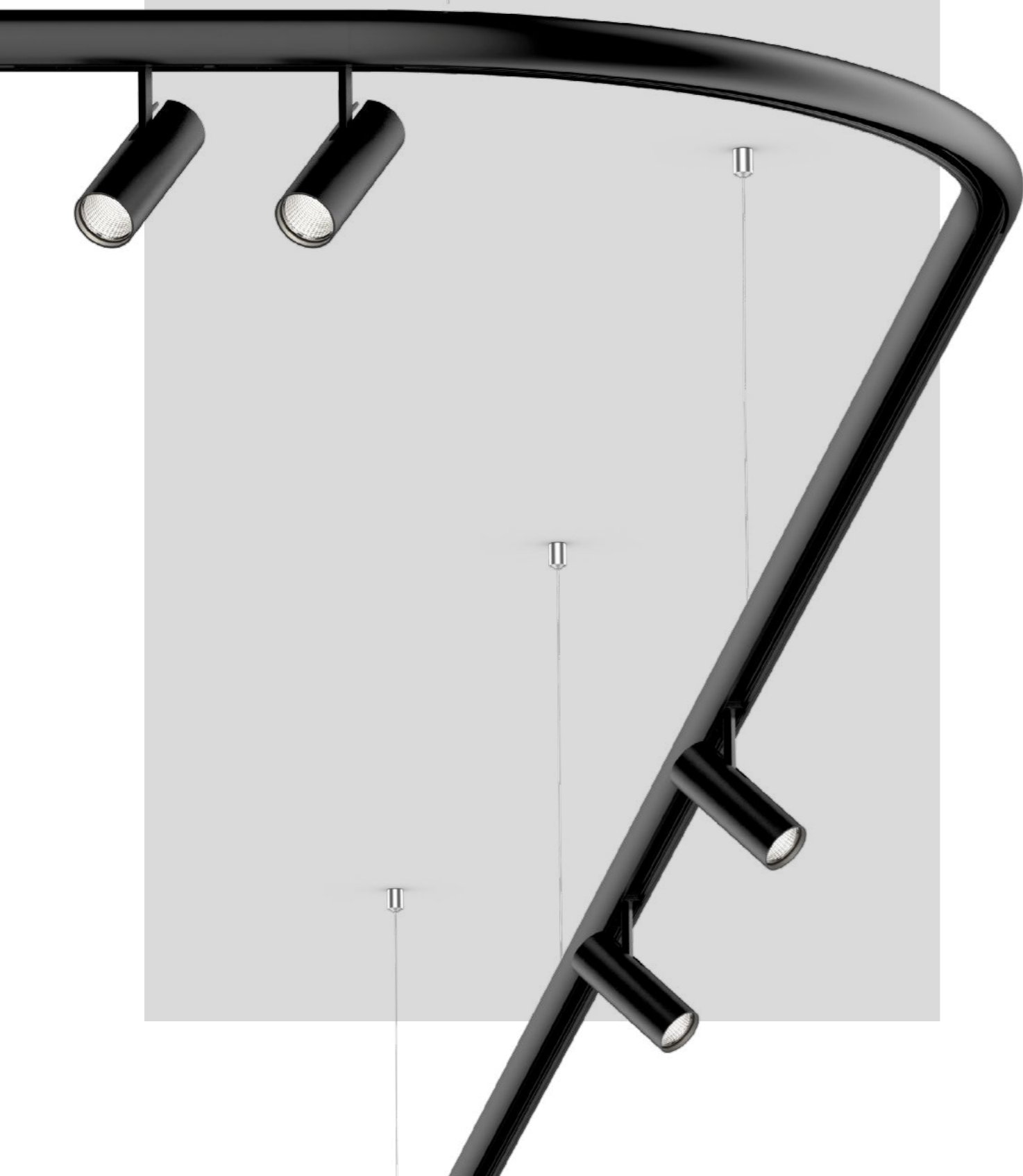

TRACK 3-phase

EN A particularly elegant and versatile track system. The three-phase track is available in square, round, or H-shaped profile form. The surface-mounted and suspended versions deliver further design freedom when combined with curved and corner connectors. The suspended H-profile enables exciting ceiling accentuation through optional light insets on the top of the profile. In many variants, the adapter disappears entirely in the profile and supports the reduced look. The high-quality appearance is enhanced by choosing between the colours white, grey, and black.

DE Ein besonders elegantes Stromschienensystem, das durch Vielseitigkeit überzeugt. Die 3-Phasen-Schiene ist in eckiger, runder oder H-förmiger Profilform erhältlich. In Kombination mit Kurven- und Eckverbindern geben die Anbau- und abgehängte Variante noch mehr Gestaltungsfreiraum. Das abgehängte H-Profil ermöglicht eine spannende Deckenakzentuierung durch optionale Lichteinsätze an der Profiloberseite. In vielen Varianten verschwindet der Adapter vollständig im Profil und unterstützt die reduzierte Optik. Die hochwertige Erscheinung wird durch die Farbauswahl Weiß, Grau und Schwarz verstärkt.

Types



30x40 45 30x80

Mountings

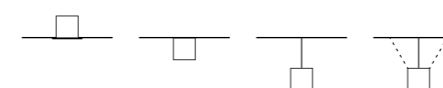

recessed surface suspended indirect
suspended

Configurations

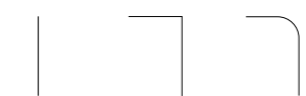

linear corner curve

Compatible spotlights

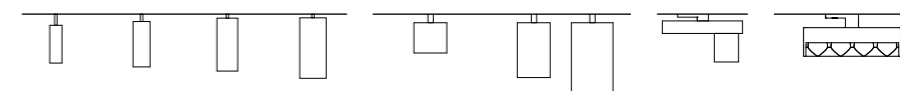

BO 32 BO 45 BO 55 BO 70 VARO 80 S VARO 80/110 PABLO SQUADRO

Mounting options

EN The three-phase tracks are available as recessed, surface-mounted, and suspended versions.

DE Die 3-Phasen-Stromschienen sind als Einbau-, Anbau- und Suspended-Variante verfügbar.

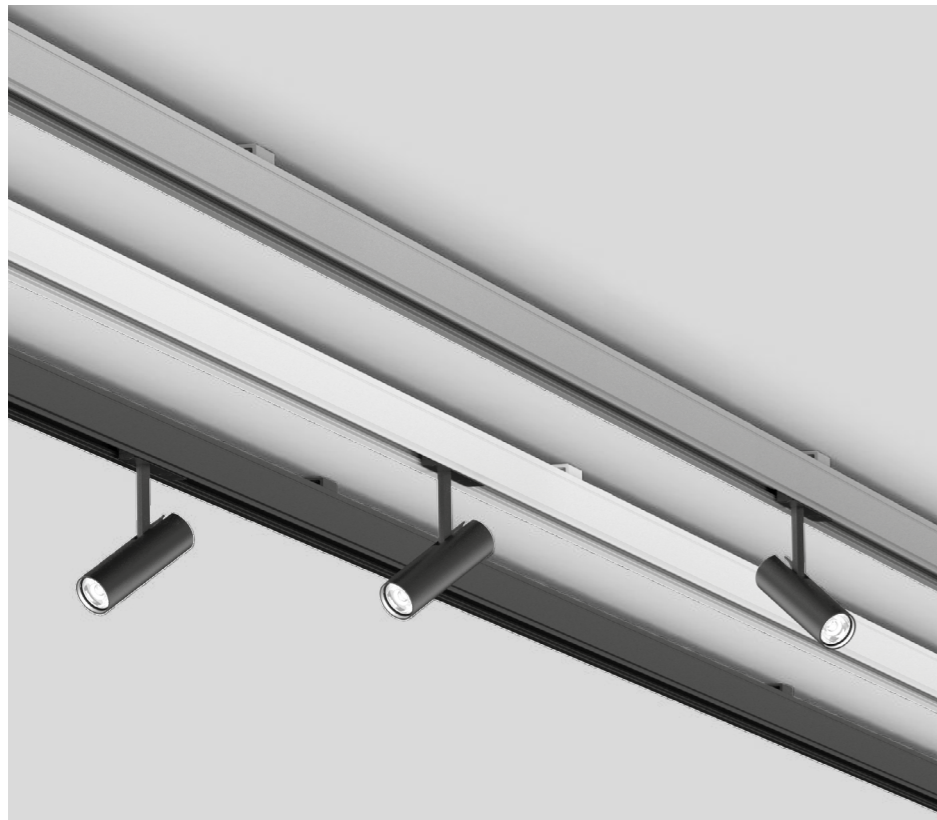
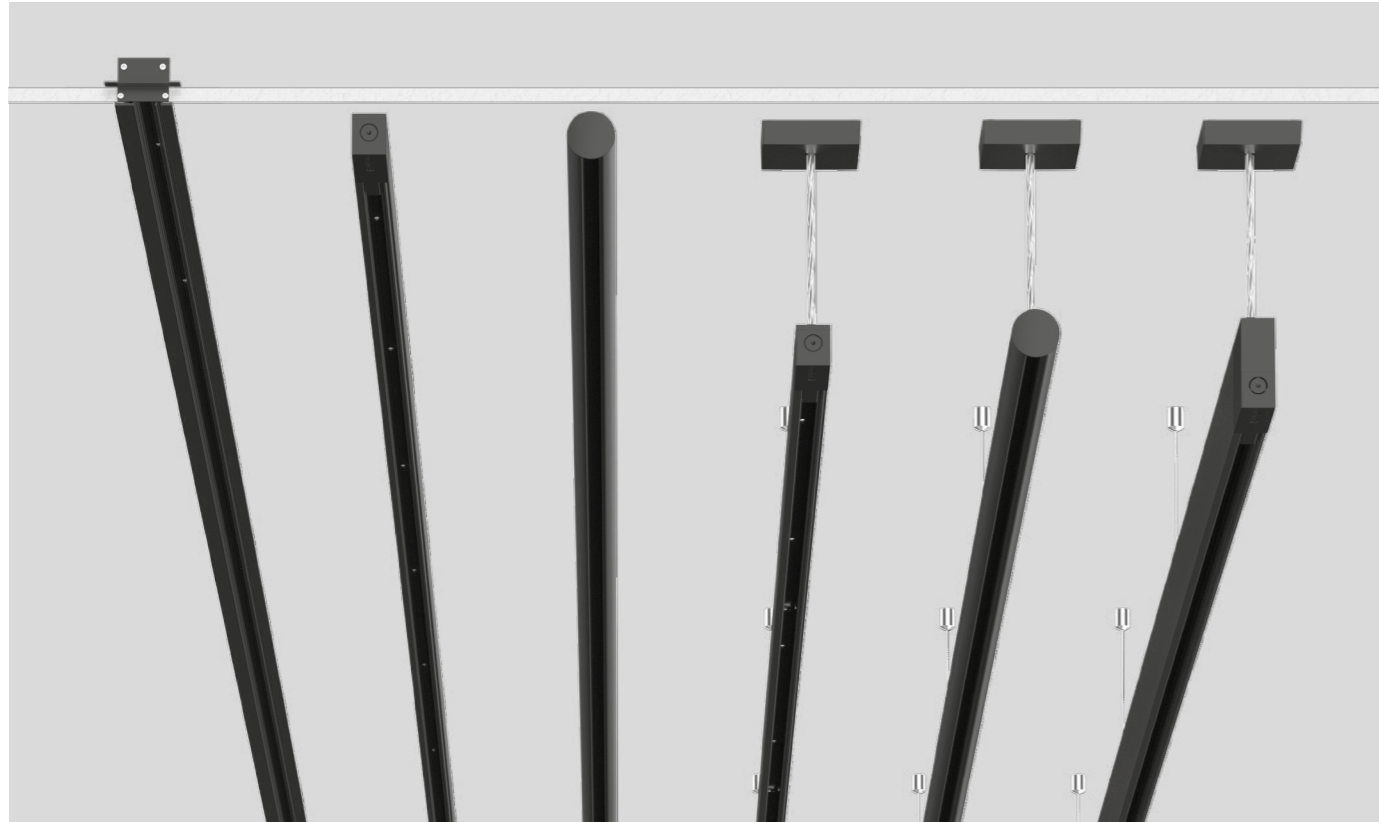

Colour variety

EN Tracks are available in different standard colours: white, grey, and black.

DE Die Stromschienen sind in unterschiedlichen Standardfarben von Weiß, Grau und Schwarz erhältlich.



Track variety

EN Available in round, square, and H-shape, the profile offers custom application options. Concealing the adapter in the profile creates a visually calm ceiling image. This concealment is available in the surface-mounted and suspended variants, in both the round and square forms. The unique feature of the suspended H-profile is that it can create indirect light by mounting, without tools, lighting insets on the top.

DE In runder, eckiger und in H-Form erhältlich bietet das Profil individuelle Einsatzmöglichkeiten. In der Anbau- und Suspended-Variante, verfügbar in runder und eckiger Form, entsteht durch den im Profil verborgenen Adapter ein optisch ruhiges Deckenbild. Die Besonderheit des abgehängten H-Profiles: Lichteinsätze können auch an der Oberseite werkzeuglos montiert werden, um indirektes Licht zu erzeugen.

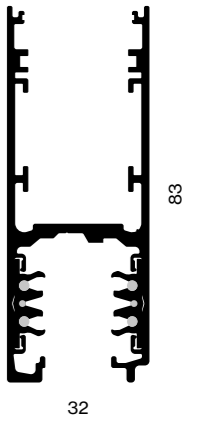
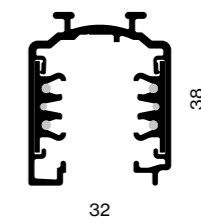
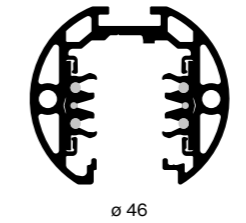
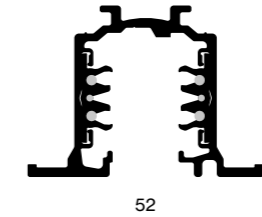

Curve and corner elements

EN Additional creative design options are opened when combined with curve and corner elements. The lighting system can thus be adapted to the different contours of the respective architecture.

DE In Kombination mit Eck- und Kurvenelementen ergeben sich zusätzlich kreative Gestaltungsoptionen. Somit lässt sich das Beleuchtungssystem an die unterschiedlichen Konturen der jeweiligen Architektur anpassen.



← back



TRACK 3-phase

recessed / surface / suspended

Types

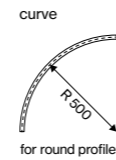
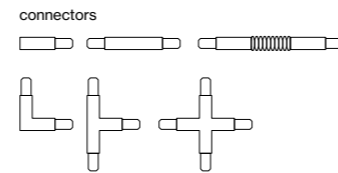
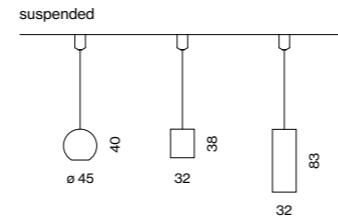
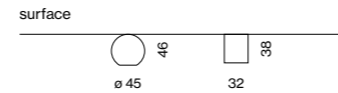
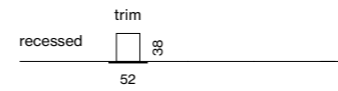

Colours



← back

TRACK recessed

Order options

CONTROL
 non DIM
 DALI-2

MATERIAL COLOUR

- pure white RAL 9010 7
- jet black RAL 9005 8

Pole options

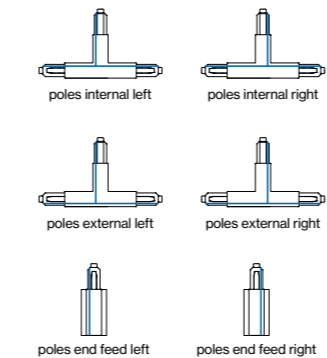

curve connector



optimised adapter integration

TRACK 3-phase/3-phase + DALI-2-bus



TRACK 240V-16A

L (mm)	ORDER CODE
2000	186-012213
3000	186-012313
4000	186-012413

end cap 186-022011

end feed left 186-022313
 end feed right 186-022413
 middle feed 186-021323

CONNECTORS 240V-16A

TYPE **ORDER CODE**
 linear connector 186-021113

L-connector 186-022123

L-connector right 186-022133
 L-connector left 186-022233

T-connector right (poles internal) 186-022143
 T-connector left (poles internal) 186-022243
 T-connector right (poles external) 186-022173
 T-connector left (poles external) 186-022273

X-connector 186-022153

MOUNTING ACCESSORIES

TYPE **ORDER CODE**
 clip 186-0225110

cutting tool 186-0219110

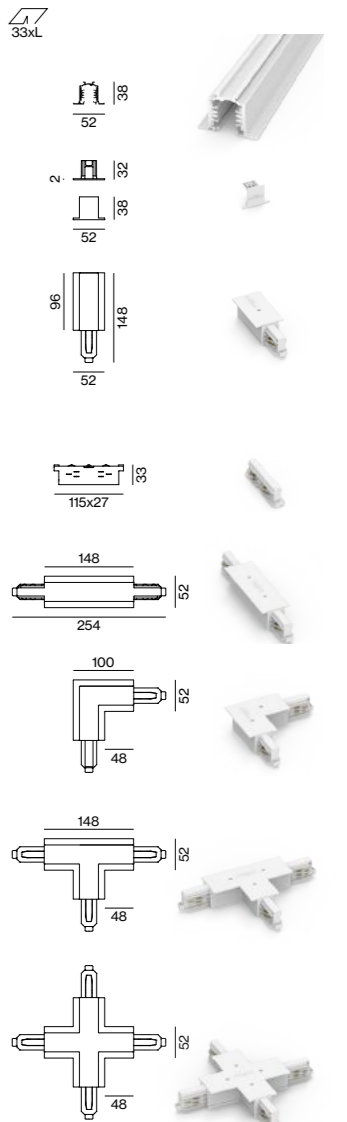

← back

TRACK

surface/suspended

Order options

CONTROL

non DIM
DALI-2

MATERIAL COLOUR

- pure white RAL 9010 7
- white aluminium RAL 9006 6
- jet black RAL 9005 8

Pole options

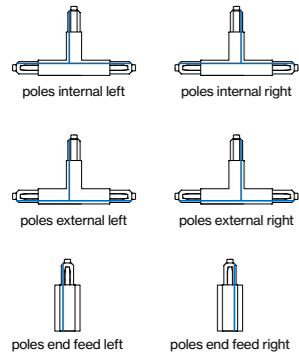

TRACK 3-phase/3-phase + DALI-2-bus



TRACK 240V-16A

L (mm)	ORDER CODE
1000	186-011123
2000	186-011223
3000	186-011323
4000	186-011423

end cap 186-021011

end feed left 186-021313
end feed right 186-021413
middle feed* 186-021323

*only available in white and black

CONNECTORS 240V-16A

TYPE ORDER CODE
linear connector 186-021113

I-connector 186-021123

L-connector right 186-021133
L-connector left 186-021233

T-connector right (poles internal) 186-021143
T-connector left (poles internal) 186-021243
T-connector right (poles external) 186-021173
T-connector left (poles external) 186-021273

X-connector 186-021153

adjustable corner connector 186-021163

MOUNTING ACCESSORIES

TYPE ORDER CODE
ceiling clip 186-021511

pendant clip cable 186-021521
pendant clip rod 186-021541

joiner piece cable 186-021531
joiner piece rod 186-021551

cutting tool 186-0219110

SUSPENSION KIT

TYPE ORDER CODE
pendant 1000 186-021611

cable 1500 186-0217110
cable 3000 186-0217210
cable 6200 186-0217310

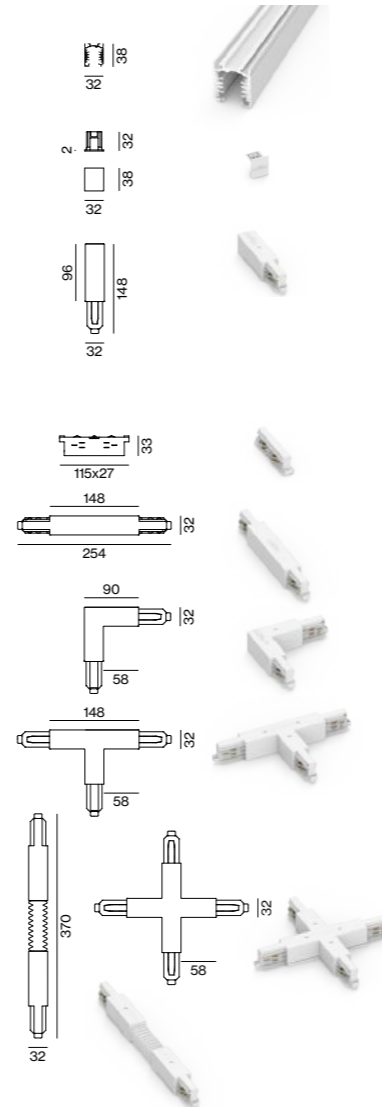

← back

TRACK high

surface/suspended

Order options

CONTROL

non DIM
DALI-2

MATERIAL COLOUR

- pure white RAL 9010 7
- jet black RAL 9005 8

Options on request

LIGHT OPTIC COVER

inset indirect

Pole options

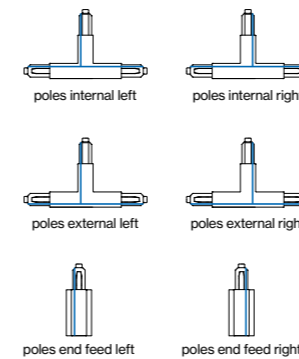

TRACK high 3-phase/3-phase + DALI-2-bus

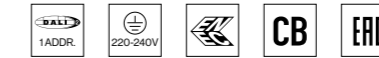

TRACK 240V-16A

L (mm)	ORDER CODE
1000	186-016113
2000	186-016213
3000	186-016313
4000	186-016413

end cap 186-026011

end feed left 186-026313
end feed right 186-026413
middle feed 186-021323

CONNECTORS 240V-16A

TYPE ORDER CODE
linear connector 186-026113

I-connector 186-026123

L-connector right 186-026133
L-connector left 186-026233

T-connector right (poles internal) 186-026143
T-connector left (poles internal) 186-026243
T-connector right (poles external) 186-026173
T-connector left (poles external) 186-026273

X-connector 186-026153

MOUNTING ACCESSORIES

TYPE ORDER CODE
pendant clip cable 186-0265210
pendant sheet metal clip 186-0215220
pendant clip rod 186-0265410

joiner piece cable 186-0265310
joiner piece rod 186-0265510

cutting tool 186-0219110

SUSPENSION KIT

TYPE ORDER CODE
pendant 1000 186-021611

cable 1500 186-0217110
cable 3000 186-0217210
cable 6200 186-0217310

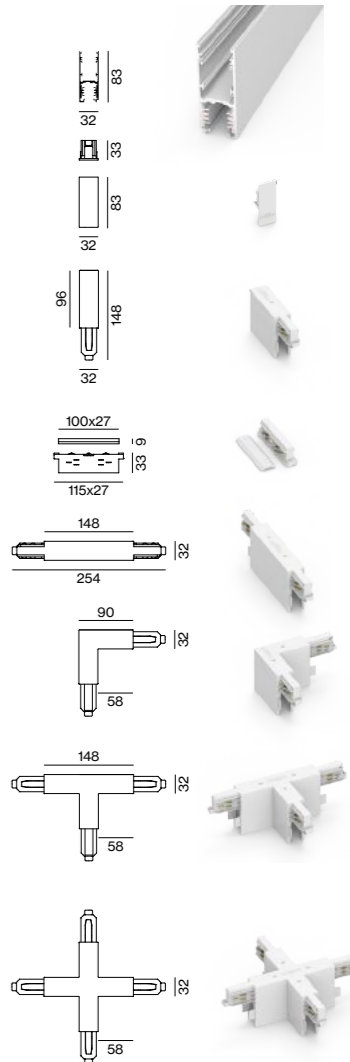

[← back](#)

TRACK round surface/suspended

Order options

CONTROL

non DIM

DALI-2

MATERIAL COLOUR

- pure white RAL 9010 7
- jet black RAL 9005 8

Options on request

CONNECTOR

T-connector

X-connector

MATERIAL COLOUR

- gold dust RAL 260-M

TRACK round 3-phase/3-phase + DALI-2-bus



TRACK 240V-16A

L (mm)	ORDER CODE
1000	186-015113
2000	186-015213
3000	186-015313
4000	186-015413



TRACK CURVE 240V-16A

TYPE	ORDER CODE
R 500 90° left	186-015853
R 500 90° right	186-015863

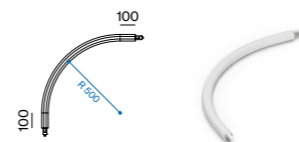

end cap	186-025011
---------	------------

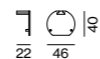

end feed left	186-025313
end feed right	186-025413
middle feed	186-021323

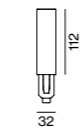

CONNECTORS 240V-16A

TYPE	ORDER CODE
linear connector	186-021113

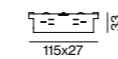

L-connector right	186-025133
L-connector left	186-025233

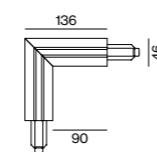

MOUNTING ACCESSORIES

TYPE	ORDER CODE
pendant clip cable	186-025521
pendant clip rod	186-025541

joiner piece cable	186-025531
joiner piece rod	186-025551

cutting tool	186-0219110
--------------	-------------

SUSPENSION KIT

TYPE	ORDER CODE
pendant 1000	186-021611

cable 1500	186-0217110
cable 3000	186-0217210
cable 6200	186-0217310

