

tala[®]

LIGHT BULBS

4 WATT | 320 LUMENS | 2500K

Classic, smooth dimmable LED filament lamp. This lamp uses 4 Watts of power and achieves 320 Lumens at a CRI of 95. It has an IP54 rating.

LAMP

Shape: C11
Materials: Brass cap, glass
Finish: Clear
Beam angle: 360°
Base: E14
Weight: 0.016 kg
Working temperature: -5C to 40C
Warm up time: Instant
Warranty: 3 years
Input Voltage: 220V-240V
Glare control: We use up to 8 LED filaments in our lamps. This, together with a thicker phosphor coating, reduces and controls glare, resulting in an even, more comfortable light.



PERFORMANCE

CRI (colour rendering index)	95
Lamp lumen output	320
Luminaire circuits per watt (LM/W)	80
Lifetime (TM-21) (hours)	30,000
Colour Temperature	2500K
Power factor	0.9

POLAR DIAGRAM

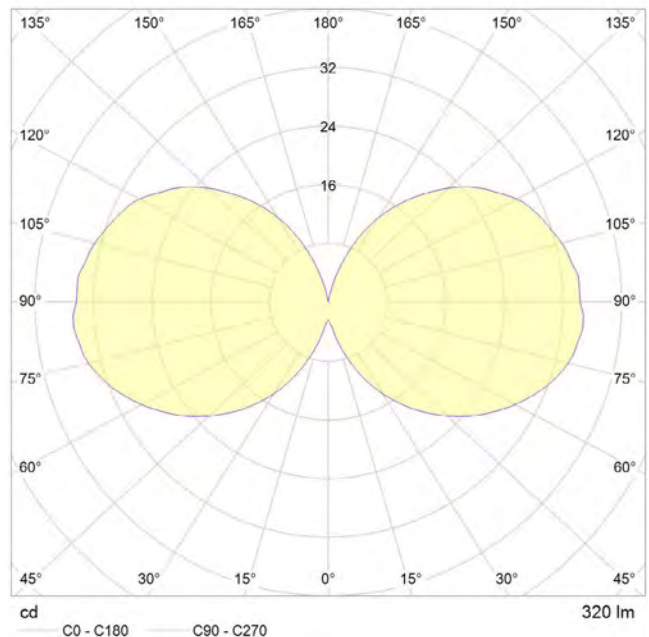

DIMMING

Dimmable: Yes
Dimming type: Trailing edge
Recommended EU Dimmer: Varilight - V-pro JXP401
 (X denotes faceplate color)

A full list of compatible dimmers is available on request.

OUTER CARTON

Pc/ Ctn: 100
Gross weight: 3.1kg
Length: 41cm
Width: 22cm
Height: 18cm

IES/LDT FILE

Available upon request.

EAN UK: 5060400150939



3 WATT | 240 LUMENS | 2200K

Classic, smooth dimmable LED filament lamp. This lamp uses 3 Watts of power and achieves 240 Lumens at a CRI of 95. It has an IP54 rating.

LAMP

Shape: T38

Materials: Brass cap, glass

Finish: Iron tinted

Beam angle: 360°

Base: E27

Weight: 0.03 kg

Working temperature: -5C to 40C

Warm up time: Instant

Warranty: 3 years

Input Voltage: 220V-240V

Glare control: We use up to 8 LED filaments in our lamps. This, together with a thicker phosphor coating, reduces and controls glare, resulting in an even, more comfortable light.



PERFORMANCE

CRI (colour rendering index)	95
Lamp lumen output	240
Luminaire circuits per watt (LM/W)	80
Lifetime (TM-21) (hours)	30,000
Colour Temperature	2200K
Power factor	0.9

POLAR DIAGRAM

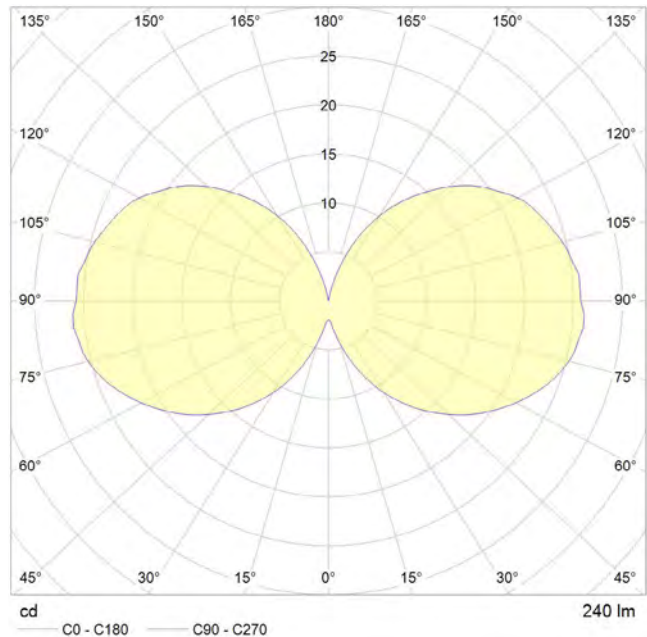

DIMMING

Dimmable: Yes

Dimming type: Trailing edge

Recommended EU Dimmer: Varilight - V-pro JXP401

(X denotes faceplate color)

A full list of compatible dimmers is available on request.

OUTER CARTON

Pc/ Ctn: 100

Gross weight: 0.35kg

Length: 48cm

Width: 25cm

Height: 25cm

IES/LDT FILE

Available upon request.

EAN UK: 5060400150960



3 WATT | 240 LUMENS | 2500K

Classic, smooth dimmable LED filament lamp. This lamp uses 3 Watts of power and achieves 240 Lumens at a CRI of 95. It has an IP54 rating.

LAMP

Shape: G45
Materials: Brass cap, glass
Finish: Clear
Beam angle: 360°
Base: E14
Weight: 0.015 kg
Working temperature: -5C to 40C
Warm up time: Instant
Warranty: 3 years
Input Voltage: 220V-240V
Glare control: We use up to 8 LED filaments in our lamps. This, together with a thicker phosphor coating, reduces and controls glare, resulting in an even, more comfortable light.

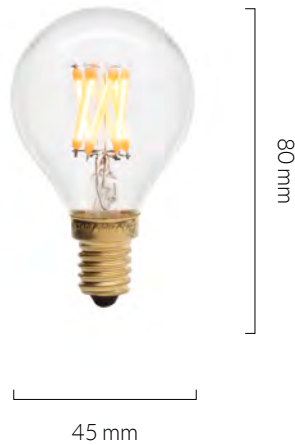

PERFORMANCE

CRI (colour rendering index)	95
Lamp lumen output	240
Luminaire circuits per watt (LM/W)	80
Lifetime (TM-21) (hours)	30,000
Colour Temperature	2500K
Power factor	0.9

POLAR DIAGRAM

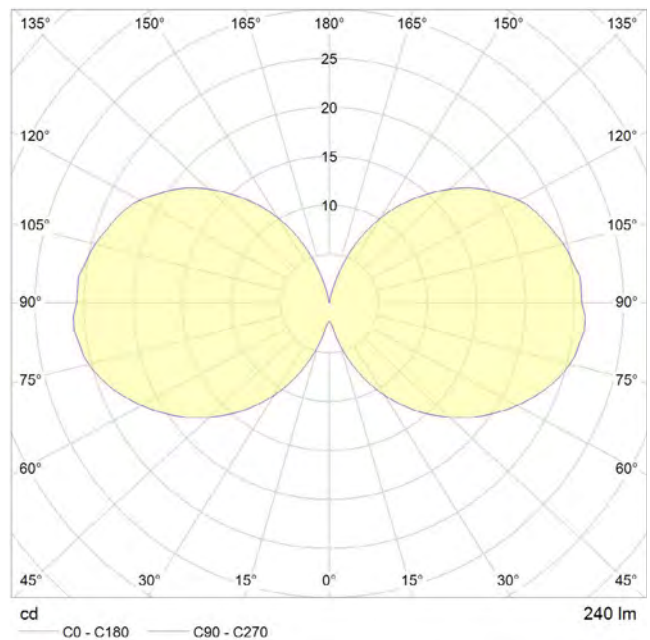

DIMMING

Dimmable: Yes
Dimming type: Trailing edge
Recommended EU Dimmer: Varilight - V-pro JXP401
 (X denotes faceplate color)

A full list of compatible dimmers is available on request.

OUTER CARTON

Pc/ Ctn: 100
Gross weight: 3.2kg
Length: 52cm
Width: 28cm
Height: 20cm

IES/LDT FILE

Available upon request.

EAN UK: 5060400151486



3 WATT | 240 LUMENS | 2200K

Classic, smooth dimmable LED filament lamp. This lamp uses 3 Watts of power and achieves 240 Lumens at a CRI of 95. It has an IP54 rating.

LAMP

Shape: G45
Materials: Brass cap, glass
Finish: Iron tinted
Beam angle: 360°
Base: E14
Weight: 0.015 kg
Working temperature: -5C to 40C
Warm up time: Instant
Warranty: 3 years
Input Voltage: 220V-240V
Glare control: We use up to 8 LED filaments in our lamps. This, together with a thicker phosphor coating, reduces and controls glare, resulting in an even, more comfortable light.



PERFORMANCE

CRI (colour rendering index)	95
Lamp lumen output	240
Luminaire circuits per watt (LM/W)	80
Lifetime (TM-21) (hours)	30,000
Colour Temperature	2200K
Power factor	0.9

POLAR DIAGRAM

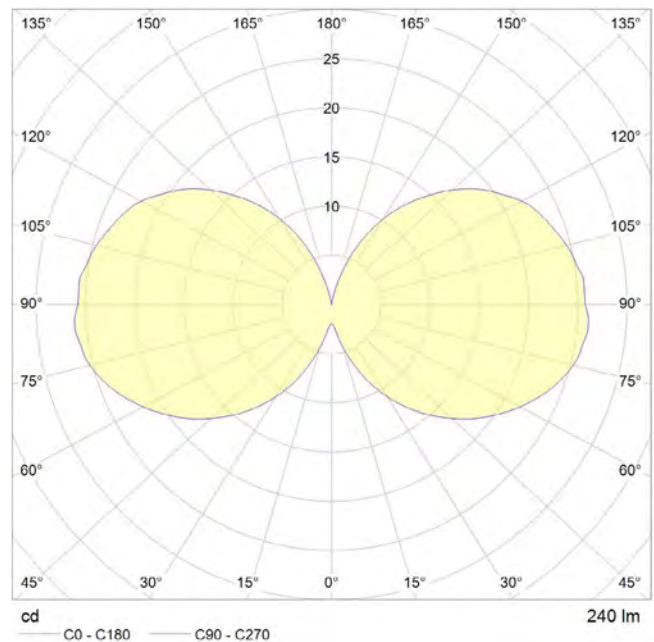

DIMMING

Dimmable: Yes
Dimming type: Trailing edge
Recommended EU Dimmer: Varilight - V-pro JXP401
 (X denotes faceplate color)

A full list of compatible dimmers is available on request.

OUTER CARTON

Pc/ Ctn: 100
Gross weight: 3.2kg
Length: 52cm
Width: 28cm
Height: 20cm

IES/LDT FILE

Available upon request.

EAN UK: 5060400150953

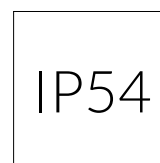

6 WATT | 480 LUMENS | 2500K

Classic, smooth dimmable LED filament lamp. This lamp uses 6 Watts of power and achieves 480 Lumens at a CRI of 95. It has an IP54 rating.

LAMP

Shape: A60
Materials: Brass cap, glass
Finish: Clear
Beam angle: 360°
Base: E27
Weight: 0.043 kg
Working temperature: -5C to 40C
Warm up time: Instant
Warranty: 3 years
Input Voltage: 220V-240V
Glare control: We use up to 8 LED filaments in our lamps. This, together with a thicker phosphor coating, reduces and controls glare, resulting in an even, more comfortable light.



PERFORMANCE

CRI (colour rendering index)	95
Lamp lumen output	480
Luminaire circuits per watt (LM/W)	80
Lifetime (TM-21) (hours)	30,000
Colour Temperature	2500K
Power factor	0.9

POLAR DIAGRAM

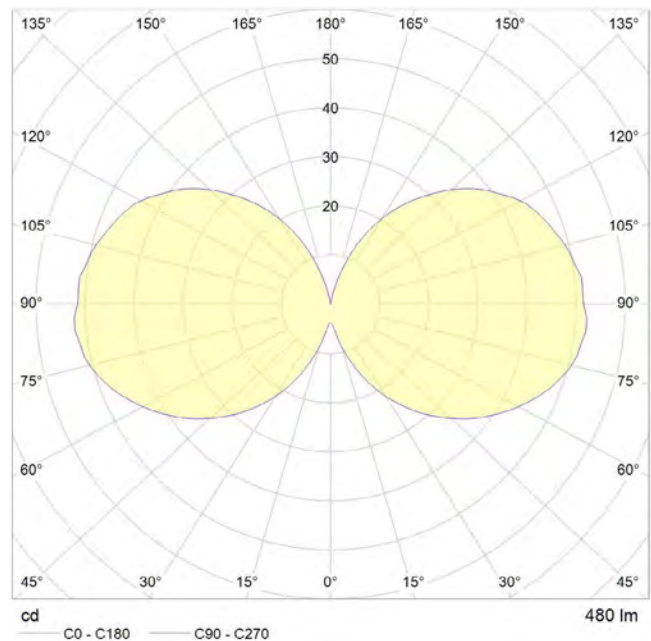

DIMMING

Dimmable: Yes
Dimming type: Trailing edge
Recommended EU Dimmer: Varilight - V-pro JXP401
 (X denotes faceplate color)

A full list of compatible dimmers is available on request.

OUTER CARTON

Pc/ Ctn: 100
Gross weight: 6.5kg
Length: 68cm
Width: 36cm
Height: 28cm

IES/LDT FILE

Available upon request.

EAN UK: 5060400150991



2 WATT | 130 LUMENS | 2200K

Classic, smooth dimmable LED filament lamp. This lamp uses 2 Watts of power and achieves 130 Lumens at a CRI of 95. It has an IP54 rating.

LAMP

Shape: ST28
Materials: Brass cap, glass
Finish: Iron tinted
Beam angle: 360°
Base: E14
Weight: 0.01 kg
Working temperature: -5C to 40C
Warm up time: Instant
Warranty: 3 years
Input Voltage: 220V-240V
Glare control: We use up to 8 LED filaments in our lamps. This, together with a thicker phosphor coating, reduces and controls glare, resulting in an even, more comfortable light.



PERFORMANCE

CRI (colour rendering index)	95
Lamp lumen output	130
Luminaire circuits per watt (LM/W)	65
Lifetime (TM-21) (hours)	30,000
Colour Temperature	2200K
Power factor	0.9

POLAR DIAGRAM

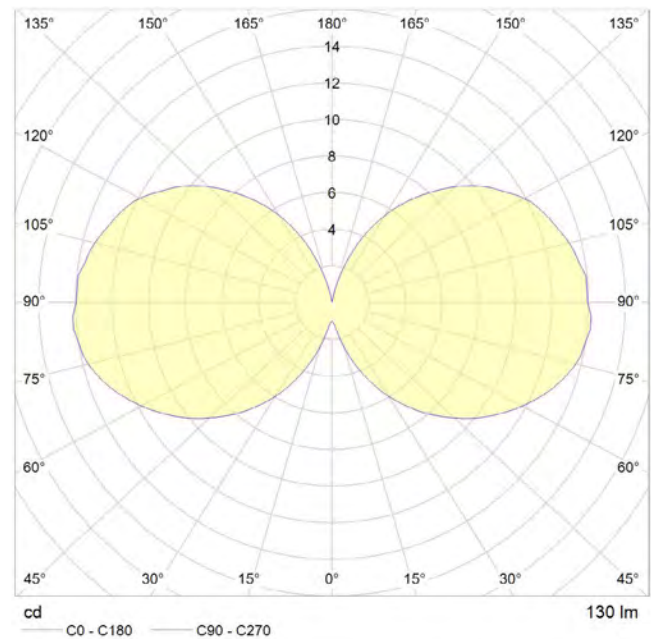

DIMMING

Dimmable: Yes
Dimming type: Trailing edge
Recommended EU Dimmer: Varilight - V-pro JXP401
 (X denotes faceplate color)

A full list of compatible dimmers is available on request.

OUTER CARTON

Pc/ Ctn: 100
Gross weight: 2.2Kg
Length: 35cm
Width: 18cm
Height: 18cm

IES/LDT FILE

Available upon request.

EAN UK: 5060400151196

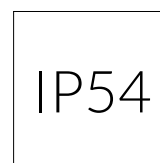

CANDLE MATTE WHITE

SKU: C35-4W-2700K-E14-MP

tala

4 WATT | 28 LUMENS | 2700K

Classic, smooth dimmable LED filament lamp. This lamp uses 4 Watts of power and delivers 280 Lumens at a CRI of 95. It has an IP54 rating.

LAMP

Shape: C35
Materials: Brass cap with glass diffuser
Finish: Matte white
Beam angle: 360°
Base: E14
Weight: 16g
Working temperature: -5°C to 40°C
Warm up time: Instant
Warranty: 3 years
Input Voltage: 220V-240V, 50/60Hz
Flicker: <5%



BULB DIMENSIONS

35 x 100 mm
(Width x Length)

PERFORMANCE

CRI (colour rendering index)	95
Lamp delivered lumen output (after diffuser losses)	280
Lumens Per Watt (LM/W)	70
Lifetime (TM-21) (hours)	30,000
Colour Temperature	2700K
Power factor	0.9

POLAR DIAGRAM

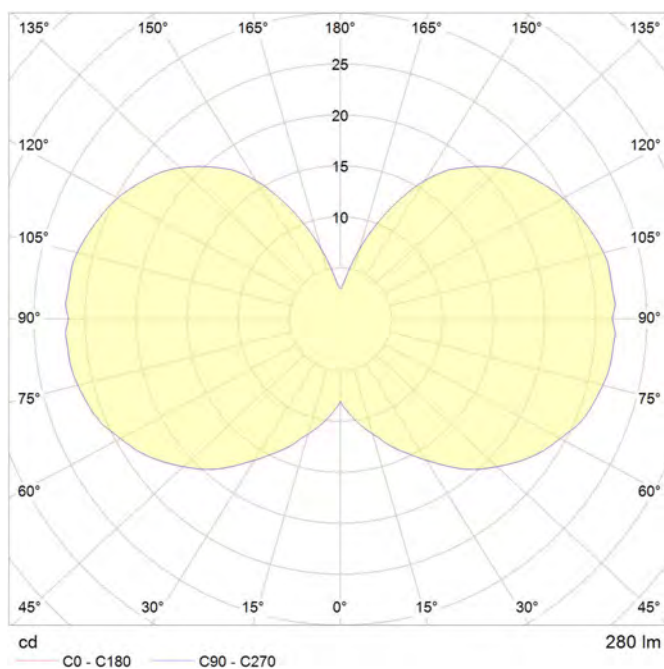

DIMMING

Dimmable: YES
Dimming type: Leading and trailing edge dimmer
Recommended Dimmer: Varilight V-Pro

A full list of compatible dimmers is available on our website:
www.tala.co.uk/recommended-dimmers/

OUTER CARTON

Pc/ Ctn:
Gross weight:
Length:
Width:
Height:

IES/LDT FILE

Available upon request.

EAN UK:



GLOBE MATTE WHITE

SKU: GLOB-6W-2700K-E27-MP

tala

6 WATT | 480 LUMENS | 2700K

Classic, smooth dimmable LED filament lamp. This lamp uses 6 Watts of power and delivers 480 Lumens at a CRI of 95. It has an IP54 rating.

LAMP

Shape: A60
Materials: Brass cap, glass
Finish: Matte White
Beam angle: 360°
Base: E27
Weight: 34g
Working temperature: -5°C to 40°C
Warm up time: Instant
Warranty: 3 years
Input Voltage: 220V-240V, 50/60Hz
Flicker: <5%



BULB DIMENSIONS

60 x 108 mm
(Width x Length)

PERFORMANCE

CRI (colour rendering index)	95
Lamp delivered lumen output (after diffuser losses)	480
Lumens Per Watt (LM/W)	80
Lifetime (TM-21) (hours)	30,000
Colour Temperature	2700K
Power factor	0.9

POLAR DIAGRAM

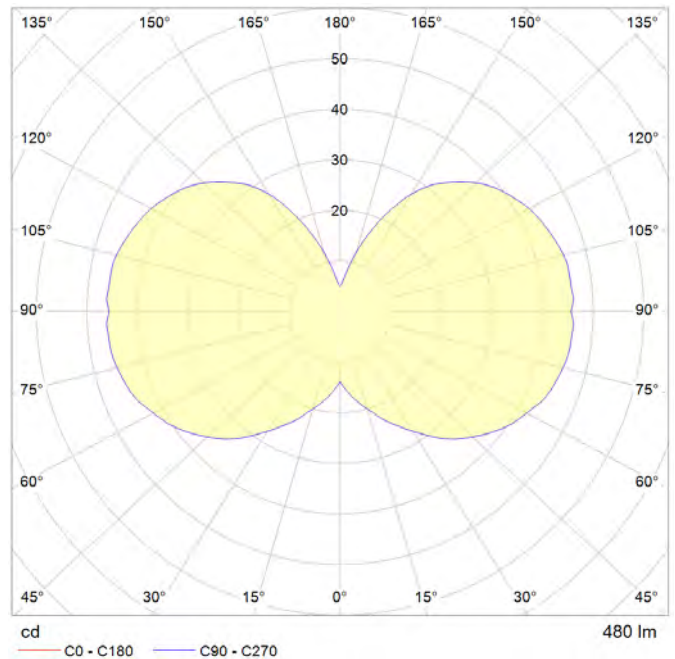

DIMMING

Dimmable: YES
Dimming type: Leading and Trailing-edge dimmer
Recommended Dimmer: Varilight V-Pro

A full list of compatible dimmers is available on our website:
www.tala.co.uk/recommended-dimmers/

OUTER CARTON

Pc/ Ctn: 5060400150991
Gross weight: 6.5kg
Length: 68cm
Width: 36cm
Height: 28cm

IES/LDT FILE

Available upon request.

EAN UK: 5060400150991



6 WATT | 480 LUMENS | 2200K

Decorative, smooth dimmable LED filament lamp. This lamp uses 6 Watts of power and achieves 480 Lumens at a CRI of 95. It has an IP54 rating.

LAMP

Shape: G95
Materials: Brass cap, glass
Finish: Iron tinted
Beam angle: 360°
Base: E27
Weight: 0.069 kg
Working temperature: -5C to 40C
Warm up time: Instant
Warranty: 3 years
Input Voltage: 220V-240V
Glare control: We use up to 8 LED filaments in our lamps. This, together with a thicker phosphor coating, reduces and controls glare, resulting in an even, more comfortable light.



BEST PAIRED WITH

1. Brass Pendant



PERFORMANCE

CRI (colour rendering index)	95
Lamp lumen output	480
Luminaire circuits per watt (LM/W)	80
Lifetime (TM-21) (hours)	30,000
Colour Temperature	2200K
Power factor	0.9

POLAR DIAGRAM

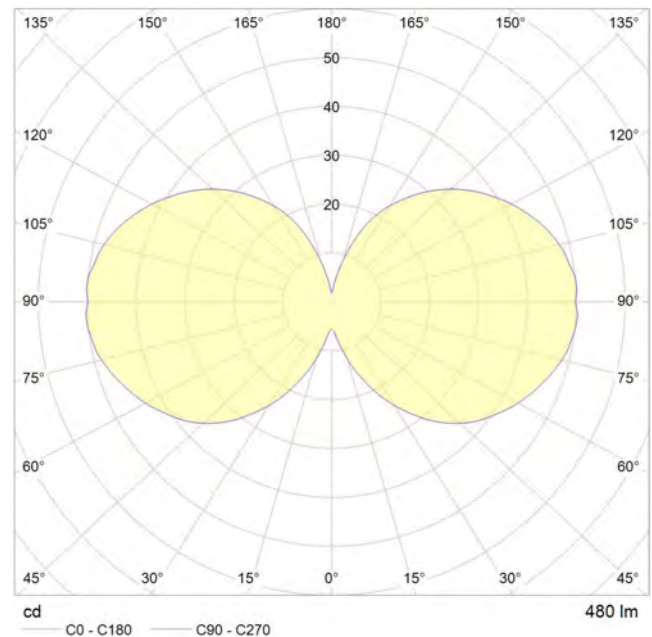

DIMMING

Dimmable: Yes
Dimming type: Trailing edge
Recommended EU Dimmer: Varilight - V-pro JXP401
(X denotes faceplate color)

A full list of compatible dimmers is available on request.

OUTER CARTON

Pc/ Ctn: 50
Gross weight: 6.1Kg
Length: 54cm
Width: 54cm
Height: 32cm

IES/LDT FILE

Available upon request.

EAN UK: 5060400151073



6 WATT | 480 LUMENS | 2200K

Decorative, smooth dimmable LED filament lamp. This lamp uses 6 Watts of power and achieves 480 Lumens at a CRI of 95. It has an IP54 rating.

LAMP

Shape: G95
Materials: Brass cap, glass
Finish: Clear
Beam angle: 360°
Base: E27
Weight: 0.069 kg
Working temperature: -5C to 40C
Warm up time: Instant
Warranty: 3 years
Input Voltage: 220V-240V
Glare control: We use up to 8 LED filaments in our lamps. This, together with a thicker phosphor coating, reduces and controls glare, resulting in an even, more comfortable light.



BEST PAIRED WITH

1. Brass Pendant



PERFORMANCE

CRI (colour rendering index)	95
Lamp lumen output	480
Luminaire circuits per watt (LM/W)	80
Lifetime (TM-21) (hours)	30,000
Colour Temperature	2200K
Power factor	0.9

POLAR DIAGRAM

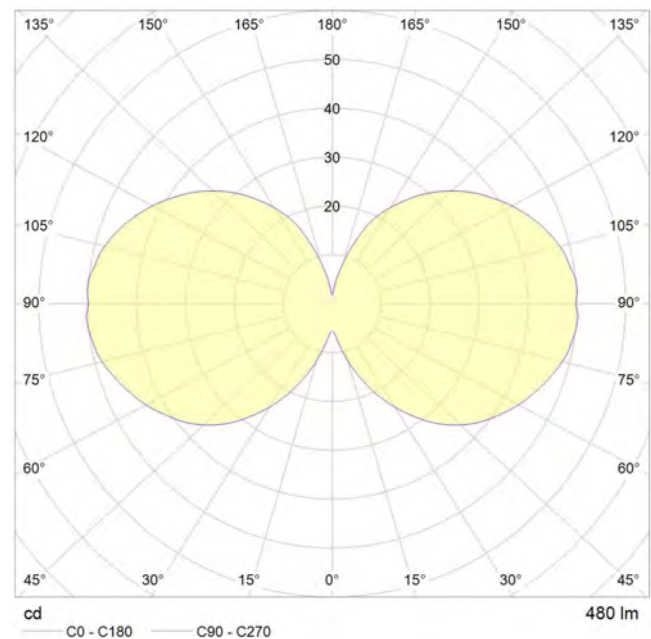

DIMMING

Dimmable: Yes
Dimming type: Trailing edge
Recommended EU Dimmer: Varilight - V-pro JXP401
 (X denotes faceplate color)

A full list of compatible dimmers is available on request.

OUTER CARTON

Pc/ Ctn: 50
Gross weight: 6.1Kg
Length: 54cm
Width: 54cm
Height: 32cm

IES/LDT FILE

Available upon request.

EAN UK: 5060400151059



6 WATT | 480 LUMENS | 2200K

Decorative, smooth dimmable LED filament lamp. This lamp uses 6 Watts of power and achieves 480 Lumens at a CRI of 95. It has an IP54 rating.

LAMP

Shape: G125
Materials: Brass cap, glass
Finish: Iron tinted
Beam angle: 360°
Base: E27
Weight: 0.114 kg
Working temperature: -5C to 40C
Warm up time: Instant
Warranty: 3 years
Input Voltage: 220V-240V
Glare control: We use up to 8 LED filaments in our lamps. This, together with a thicker phosphor coating, reduces and controls glare, resulting in an even, more comfortable light.



125 mm

175 mm

BEST PAIRED WITH

- 1. Brass Pendant
- 2. Walnut Touch Lamp
- 3. Oak Touch Lamp



PERFORMANCE

CRI (colour rendering index)	95
Lamp lumen output	480
Luminaire circuits per watt (LM/W)	80
Lifetime (TM-21) (hours)	30,000
Colour Temperature	2200K
Power factor	0.9

POLAR DIAGRAM

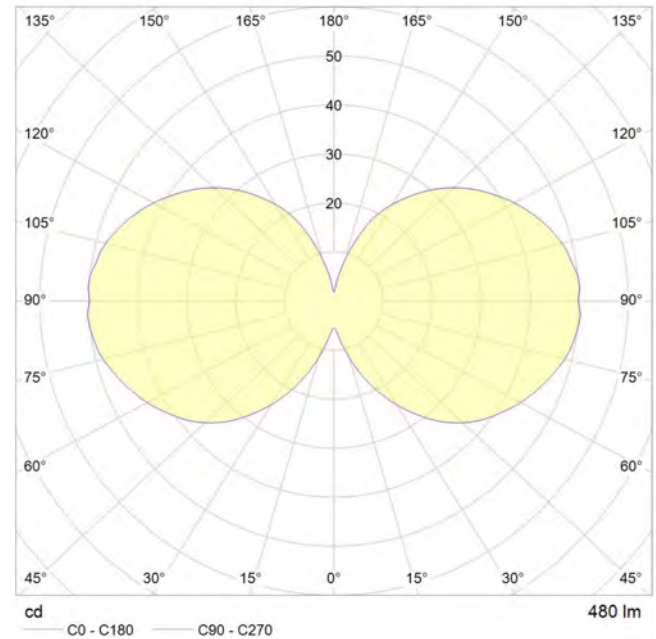

DIMMING

Dimmable: Yes
Dimming type: Trailing edge
Recommended EU Dimmer: Varilight - V-pro JXP401
 (X denotes faceplate color)

A full list of compatible dimmers is available on request.

OUTER CARTON

Pc/ Ctn: 20
Gross weight: 4.3Kg
Length: 68cm
Width: 28cm
Height: 42cm

IES/LDT FILE

Available upon request.

EAN UK: 5060400151110



SQUIRREL CAGE

SKU: SQCG-3W-2200K-E27-T

tala

3 WATT | 210 LUMENS | 2200K

Decorative, smooth dimmable LED filament lamp. This lamp uses 3 Watts of power and achieves 210 Lumens at a CRI of 95. It has an IP54 rating.

LAMP

Shape: ST64
Materials: Brass cap, glass
Finish: Iron tinted
Beam angle: 360°
Base: E27
Weight: 0.091 kg
Working temperature: -5C to 40C
Warm up time: Instant
Warranty: 3 years
Input Voltage: 220V-240V
Glare control: We use up to 8 LED filaments in our lamps. This, together with a thicker phosphor coating, reduces and controls glare, resulting in an even, more comfortable light.



140 mm

64 mm

BEST PAIRED WITH

1. Brass Pendant



PERFORMANCE

CRI (colour rendering index)	95
Lamp lumen output	210
Luminaire circuits per watt (LM/W)	80
Lifetime (TM-21) (hours)	30,000
Colour Temperature	2200K
Power factor	0.9

POLAR DIAGRAM

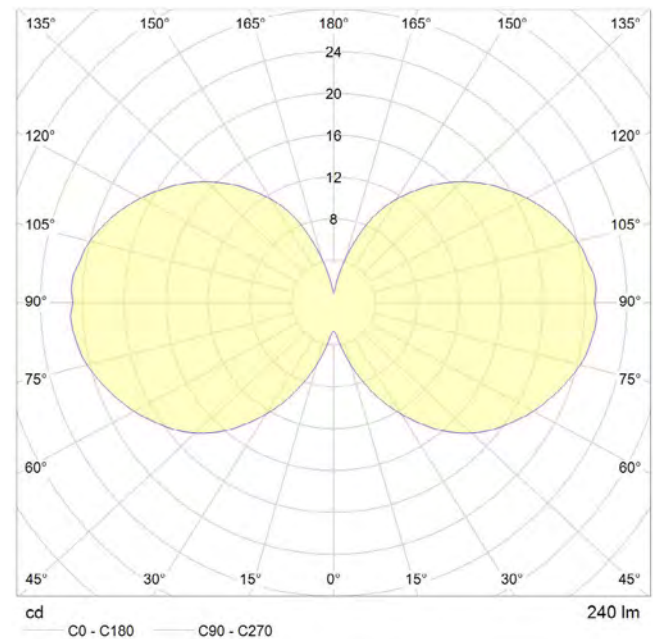

DIMMING

Dimmable: Yes
Dimming type: Trailing edge
Recommended EU Dimmer: Varilight - V-pro JXP401
(X denotes faceplate color)

A full list of compatible dimmers is available on request.

OUTER CARTON

Pc/ Ctn: 100
Gross weight: 8.2Kg
Length: 73cm
Width: 37cm
Height: 33cm

IES/LDT FILE

Available upon request.

EAN UK: 5060400151011



www.tala.co.uk | hello@tala.co.uk | +44 (0) 20 3026 3246

Specification subject to change without notice. Refer to our website for the most recent product documentation.

3 WATT | 240 LUMENS | 2200K

Decorative, smooth dimmable LED filament lamp. This lamp uses 3 Watts of power and achieves 240 Lumens at a CRI of 95. It has an IP54 rating.

LAMP

Shape: T25
Materials: Brass cap, glass
Finish: Iron tinted
Beam angle: 360°
Base: E14
Weight: 0.012 kg
Working temperature: -5C to 40C
Warm up time: Instant
Warranty: 3 years
Input Voltage: 220V-240V
Glare control: We use up to 8 LED filaments in our lamps. This, together with a thicker phosphor coating, reduces and controls glare, resulting in an even, more comfortable light.



BEST PAIRED WITH

- All E14 fixtures

PERFORMANCE

CRI (colour rendering index)	95
Lamp lumen output	240
Luminaire circuits per watt (LM/W)	80
Lifetime (TM-21) (hours)	30,000
Colour Temperature	2200K
Power factor	0.9

POLAR DIAGRAM

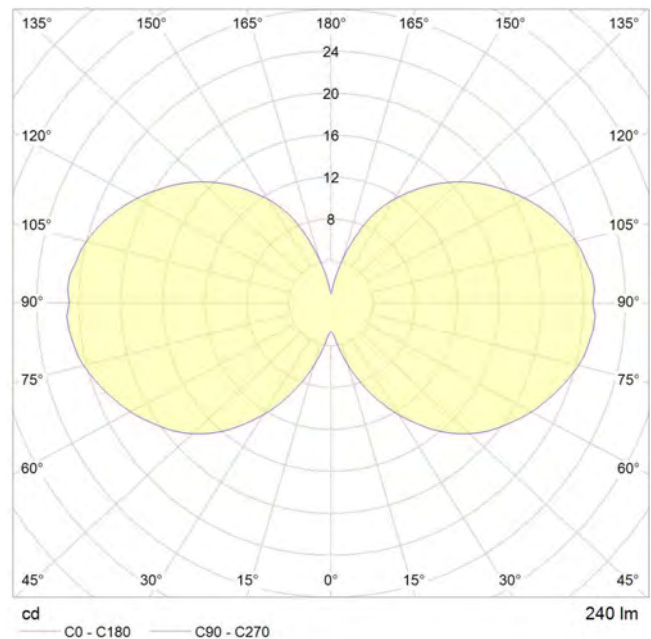

DIMMING

Dimmable: Yes
Dimming type: Trailing edge
Recommended EU Dimmer: Varilight - V-pro JXP401
 (X denotes faceplate color)

A full list of compatible dimmers is available on request.

OUTER CARTON

Pc/ Ctn: 100
Gross weight: 2.5kg
Length: 39cm
Width: 19cm
Height: 22cm

IES/LDT FILE

Available upon request.

EAN UK: 5060400151455

IP54



4 WATT | 320 LUMENS | 2200K

Decorative, smooth dimmable LED filament lamp. This lamp uses 4 Watts of power and achieves 320 Lumens at a CRI of 95. It has an IP54 rating.

LAMP

Shape: T30
Materials: Brass cap, glass
Finish: Iron tinted
Beam angle: 360°
Base: E27
Weight: 0.05 kg
Working temperature: -5C to 40C
Warm up time: Instant
Warranty: 3 years
Input Voltage: 220V-240V
Glare control: We use up to 8 LED filaments in our lamps. This, together with a thicker phosphor coating, reduces and controls glare, resulting in an even, more comfortable light.



30 mm



300 mm

BEST PAIRED WITH

1. Brass Pendant

1.



PERFORMANCE

CRI (colour rendering index)	95
Lamp lumen output	320
Luminaire circuits per watt (LM/W)	80
Lifetime (TM-21) (hours)	30,000
Colour Temperature	2200K
Power factor	0.9

POLAR DIAGRAM

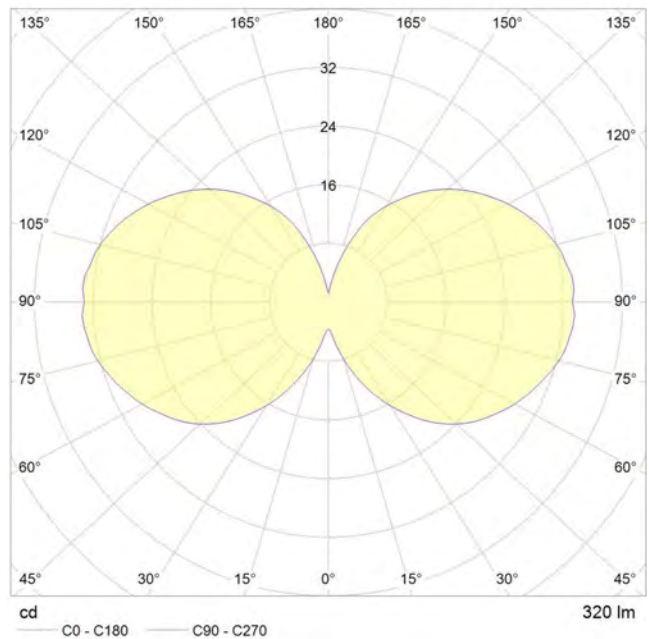

DIMMING

Dimmable: Yes
Dimming type: Trailing edge
Recommended EU Dimmer: Varilight - V-pro JXP401
 (X denotes faceplate color)

A full list of compatible dimmers is available on request.

OUTER CARTON

Pc/ Ctn: 100
Gross weight: 10.3kg
Length: 38cm
Width: 38cm
Height: 33cm

IES/LDT FILE

Available upon request.

EAN UK: 5060400151165



3 WATT | 180 LUMENS | 2700K

Smooth dimmable LED filament lamp made of matte white glass. This lamp uses 3 Watts of power and achieves 180 Lumens at a CRI of 95. It has an IP54 rating.

LAMP

Shape: G45
Materials: Brass cap, matte white glass
Finish: Matte porcelain
Beam angle: 360°
Base: E14
Weight: 0.015 kg
Working temperature: -5C to 40C
Warm up time: Instant
Warranty: 3 years
Input Voltage: 220V-240V
Glare control: We use up to 8 LED filaments in our lamps. This, together with a thicker phosphor coating, reduces and controls glare, resulting in an even, more comfortable light.



BEST PAIRED WITH

- 1. All E14 fixtures

PERFORMANCE

CRI (colour rendering index)	95
Lamp lumen output	180
Luminaire circuits per watt (LM/W)	80
Lifetime (TM-21) (hours)	30,000
Colour Temperature	2700K
Power factor	0.9

POLAR DIAGRAM

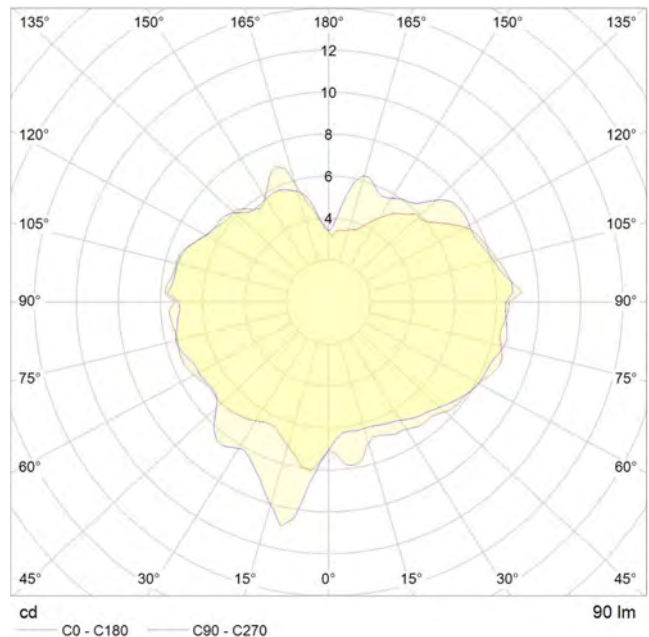

DIMMING

Dimmable: Yes
Dimming type: Trailing edge
Recommended EU Dimmer: Varilight - V-pro JXP401
 (X denotes faceplate color)

A full list of compatible dimmers is available on request.

OUTER CARTON

Pc/ Ctn: 100
Gross weight: 3.2kg
Length: 52cm
Width: 28cm
Height: 20cm

IES/LDT FILE

Available upon request.

EAN UK: 5060400150175



6 WATT | 540 LUMENS | 2700K

Smooth dimmable LED filament lamp made of matte white glass. This lamp uses 6 Watts of power and achieves 540 Lumens at a CRI of 95. It has an IP54 rating.

LAMP

Shape: G80
Materials: Brass cap, matte white glass
Finish: Matte porcelain
Beam angle: 360°
Base: E27
Weight: 0.069 kg
Working temperature: -5C to 40C
Warm up time: Instant
Warranty: 3 years
Input Voltage: 220V-240V
Glare control: We use up to 8 LED filaments in our lamps. This, together with a thicker phosphor coating, reduces and controls glare, resulting in an even, more comfortable light.



BEST PAIRED WITH

1. Brass Pendant
2. Graphite Pendant



PERFORMANCE

CRI (colour rendering index)	95
Lamp lumen output	540
Luminaire circuits per watt (LM/W)	90
Lifetime (TM-21) (hours)	30,000
Colour Temperature	2700K
Power factor	0.9

POLAR DIAGRAM

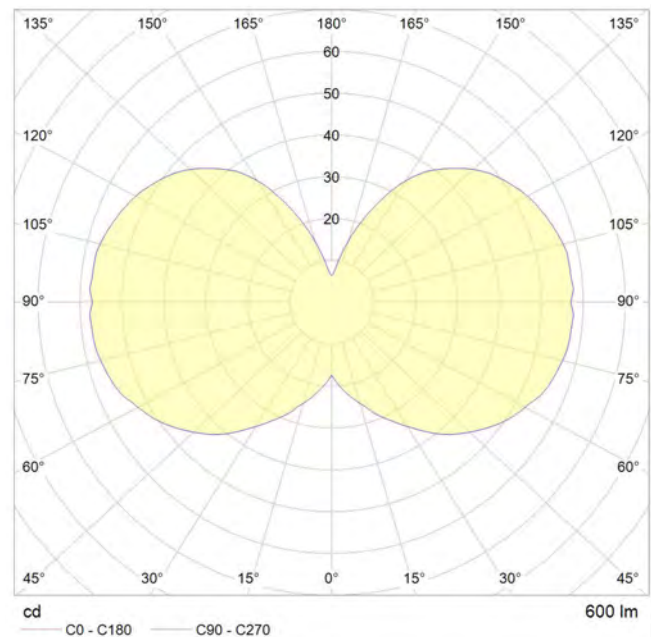

DIMMING

Dimmable: Yes
Dimming type: Trailing edge
Recommended EU Dimmer: Varilight - V-pro JXP401
 (X denotes faceplate color)

A full list of compatible dimmers is available on request.

OUTER CARTON

Pc/ Ctn: 50
Gross weight: 6.1kg
Length: 46cm
Width: 46cm
Height: 30cm

IES/LDT FILE

Available upon request.

EAN UK: 5060400150182



6 WATT | 540 LUMENS | 2700K

Smooth dimmable LED filament lamp made of matte white glass. This lamp uses 6 Watts of power and achieves 540 Lumens at a CRI of 95. It has an IP54 rating.

LAMP

Shape: G125
Materials: Brass cap, matte white glass
Finish: Matte porcelain
Beam angle: 360°
Base: E27
Weight: 0.114 kg
Working temperature: -5C to 40C
Warm up time: Instant
Warranty: 3 years
Input Voltage: 220V-240V
Glare control: We use up to 8 LED filaments in our lamps. This, together with a thicker phosphor coating, reduces and controls glare, resulting in an even, more comfortable light.



BEST PAIRED WITH

1. Brass Pendant
2. Graphite Penant
3. Walnut Touch Lamp
4. Oak Touch Lamp



PERFORMANCE

CRI (colour rendering index)	95
Lamp lumen output	540
Luminaire circuits per watt (LM/W)	90
Lifetime (TM-21) (hours)	30,000
Colour Temperature	2700K
Power factor	0.9

POLAR DIAGRAM

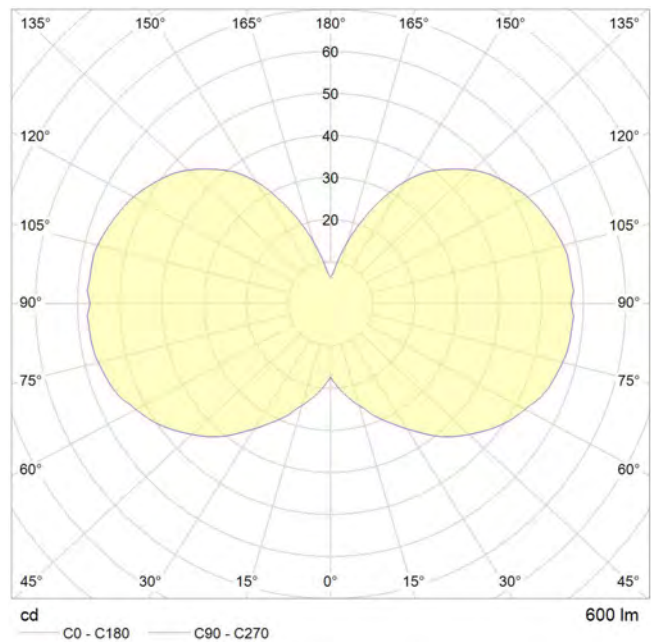

DIMMING

Dimmable: Yes
Dimming type: Trailing edge
Recommended EU Dimmer: Varilight - V-pro JXP401
 (X denotes faceplate color)

A full list of compatible dimmers is available on request.

OUTER CARTON

Pc/ Ctn: 20
Gross weight: 4.3kg
Length: 68cm
Width: 28cm
Height: 42cm

IES/LDT FILE

Available upon request.

EAN UK: 5060400150199



6 WATT | 540 LUMENS | 2700K

Smooth dimmable LED filament lamp made of mouth-blown glass. This lamp uses 6 Watts of power and achieves 540 Lumens at a CRI of 95. It has an IP54 rating.

LAMP

Shape: Custom
Materials: Brass cap, mouth-blown glass
Finish: Matte porcelain
Beam angle: 360°
Base: E27
Weight: 0.169 kg
Working temperature: -5C to 40C
Warm up time: Instant
Warranty: 3 years
Input Voltage: 220V-240V
Glare control: We use up to 8 LED filaments in our lamps. This, together with a thicker phosphor coating, reduces and controls glare, resulting in an even, more comfortable light.



BEST PAIRED WITH

1. Brass Pendant
2. Graphite Pendant
3. Oak/Walnut Pendant
4. Oak/Walnut Touch Lamp



PERFORMANCE

CRI (colour rendering index)	95
Lamp lumen output	540
Luminaire circuits per watt (LM/W)	90
Lifetime (TM-21) (hours)	30,000
Colour Temperature	2700K
Power factor	0.9

POLAR DIAGRAM

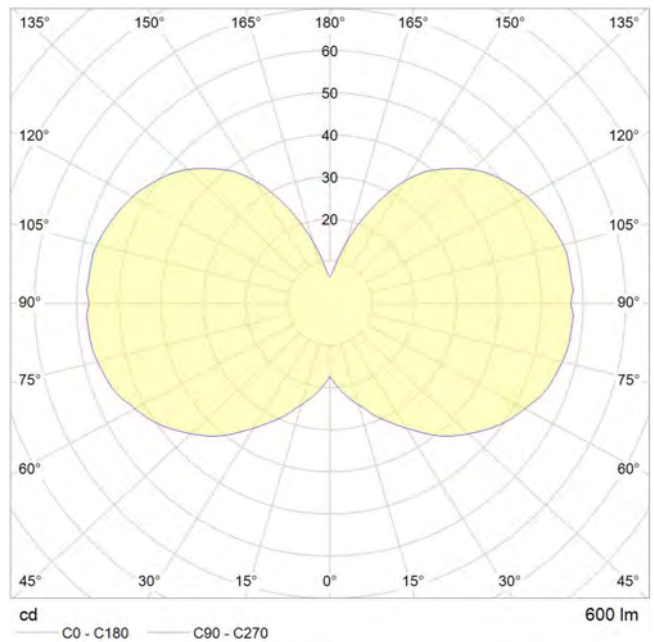

DIMMING

Dimmable: Yes
Dimming type: Trailing edge
Recommended EU Dimmer: Varilight - V-pro JXP401
 (X denotes faceplate color)

A full list of compatible dimmers is available on request.

OUTER CARTON

Pc/ Ctn: 20
Gross weight: 4.5kg
Length: 82cm
Width: 32cm
Height: 28cm

IES/LDT FILE

Available upon request.

EAN UK: 5060400150205



6 WATT | 540 LUMENS | 2700K

Smooth dimmable LED filament lamp made of mouth-blown glass. This lamp uses 6 Watts of power and achieves 540 Lumens at a CRI of 95. It has an IP54 rating.

LAMP

Shape: Custom
Materials: Brass cap, mouth-blown glass
Finish: Matte porcelain
Beam angle: 360°
Base: E27
Weight: 0.182 kg
Working temperature: -5C to 40C
Warm up time: Instant
Warranty: 3 years
Input Voltage: 220V-240V
Glare control: We use up to 8 LED filaments in our lamps. This, together with a thicker phosphor coating, reduces and controls glare, resulting in an even, more comfortable light.



BEST PAIRED WITH

1. Brass Pendant
2. Graphite Pendant
3. Oak/ Walnut Pendant
4. Oak/ Walnut Touch Lamp



PERFORMANCE

CRI (colour rendering index)	95
Lamp lumen output	540
Luminaire circuits per watt (LM/W)	90
Lifetime (TM-21) (hours)	30,000
Colour Temperature	2700K
Power factor	0.9

POLAR DIAGRAM

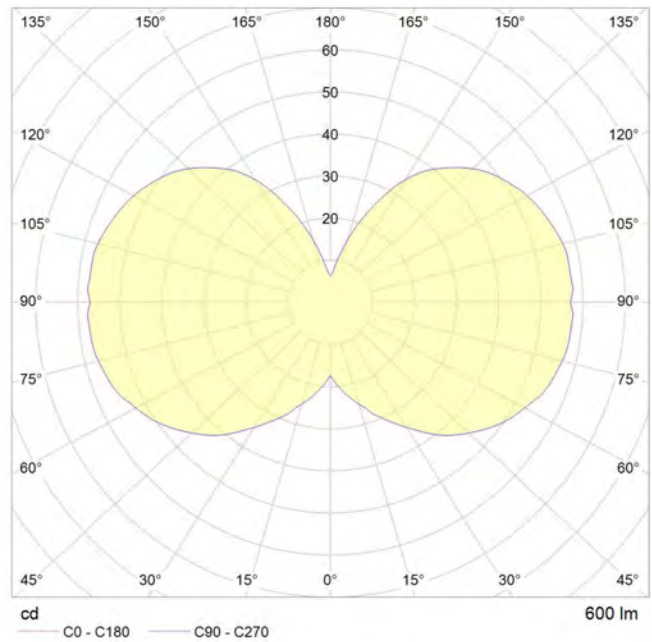

DIMMING

Dimmable: Yes
Dimming type: Trailing edge
Recommended EU Dimmer: Varilight - V-pro JXP401
 (X denotes faceplate color)

A full list of compatible dimmers is available on request.

OUTER CARTON

Pc/ Ctn: 20
Gross weight: 4.5kg
Length: 68cm
Width: 28cm
Height: 34cm

IES/LDT FILE

Available upon request.

EAN UK: 5060400150212



6 WATT | 540 LUMENS | 2700K

Smooth dimmable LED filament lamp made of mouth-blown glass. This lamp uses 6 Watts of power and achieves 540 Lumens at a CRI of 95. It has an IP54 rating.

LAMP

Shape: Custom
Materials: Brass cap, mouth-blown glass
Finish: Matte porcelain
Beam angle: 360°
Base: E27
Weight: 0.181 kg
Working temperature: -5C to 40C
Warm up time: Instant
Warranty: 3 years
Input Voltage: 220V-240V
Glare control: We use up to 8 LED filaments in our lamps. This, together with a thicker phosphor coating, reduces and controls glare, resulting in an even, more comfortable light.



BEST PAIRED WITH

1. Oak Pendant
2. Walnut Pendant
3. Brass Pendant
4. Graphite Pendant



PERFORMANCE

CRI (colour rendering index)	95
Lamp lumen output	540
Luminaire circuits per watt (LM/W)	90
Lifetime (TM-21) (hours)	30,000
Colour Temperature	2700K
Power factor	0.9

POLAR DIAGRAM

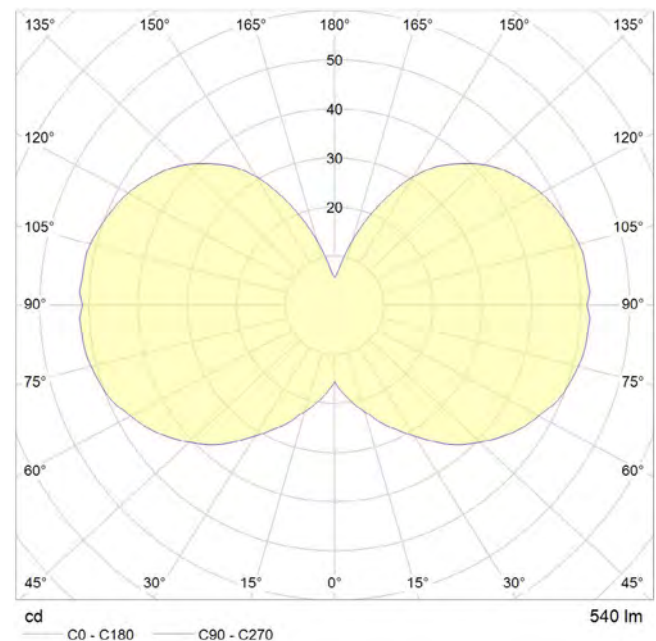

DIMMING

Dimmable: Yes
Dimming type: Trailing edge
Recommended EU Dimmer: Varilight - V-pro JXP401
 (X denotes faceplate color)

A full list of compatible dimmers is available on request.

OUTER CARTON

Pc/ Ctn: 20
Gross weight: 4.5kg
Length: 76cm
Width: 31cm
Height: 36cm

IES/LDT FILE

Available upon request.

EAN UK: 5060400150229



6 WATT | 540 LUMENS | 2700K

Smooth dimmable LED filament lamp made of mouth-blown glass. This lamp uses 6 Watts of power and achieves 540 Lumens at a CRI of 95. It has an IP54 rating.

LAMP

Shape: Custom
Materials: Brass cap, mouth-blown glass
Finish: Matte porcelain
Beam angle: 360°
Base: E27
Weight: 0.17 kg
Working temperature: -5C to 40C
Warm up time: Instant
Warranty: 3 years
Input Voltage: 220V-240V
Glare control: We use up to 8 LED filaments in our lamps. This, together with a thicker phosphor coating, reduces and controls glare, resulting in an even, more comfortable light.



BEST PAIRED WITH

1. Oak Pendant
2. Walnut Pendant
3. Brass Pendant
4. Graphite Pendant



PERFORMANCE

CRI (colour rendering index)	95
Lamp lumen output	540
Luminaire circuits per watt (LM/W)	90
Lifetime (TM-21) (hours)	30,000
Colour Temperature	2700K
Power factor	0.9

POLAR DIAGRAM

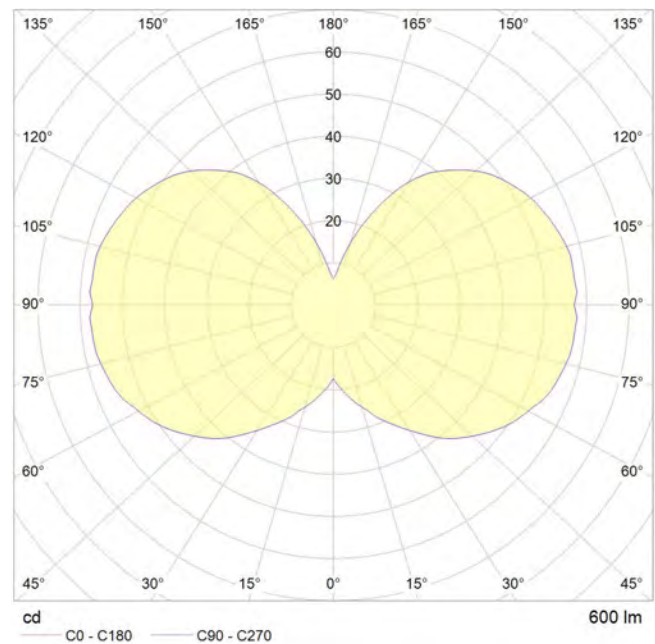

DIMMING

Dimmable: Yes
Dimming type: Trailing edge
Recommended EU Dimmer: Varilight - V-pro JXP401
 (X denotes faceplate color)

A full list of compatible dimmers is available on request.

OUTER CARTON

Pc/ Ctn: 20
Gross weight: 4.5kg
Length: 73cm
Width: 30cm
Height: 32cm

IES/LDT FILE

Available upon request.

EAN UK: 5060400150236



SPHERE I (E14)

SKU: SPHR-G50-4W-2000/2800K-E14-MP

tala

3.8 WATT | 220 LUMENS | 2000K TO 2800K

Decorative, dim to warm LED lightbulb. This lamp uses 3.8 Watts of power and achieves 220 Lumens at a CRI of 95. It has an IP54 rating.

DIM TO WARM
TECHNOLOGY



LAMP

Shape: G50
Materials: Soda-lime Glass and Brass Cap
Finish: Matte White
Beam angle: 360°
Base: E14
Weight: 17g
Working temperature: -5°C to 40°C
Warm up time: Instant
Warranty: 3 years
Input Voltage: 220-240V, 50/60Hz



BULB DIMENSIONS

50 x 82 mm
(Width x Length)

PERFORMANCE

CRI (colour rendering index)	95
Lamp lumen output	220lm
Flicker	<5%
Lumens per circuit watt (LM/W)	58lm/W
Lifetime (TM-21) (hours)	15,000hrs
Colour Temperature	2000K - 2800K
Power factor	0.9

DIMMING

Dimmable: Yes
Dimming type: Leading or trailing edge dimmer
Recommended EU Dimmer: Varilight - V-pro

A full list of compatible dimmers is available on our website:
www.tala.co.uk/recommended-dimmers/

POLAR DIAGRAM

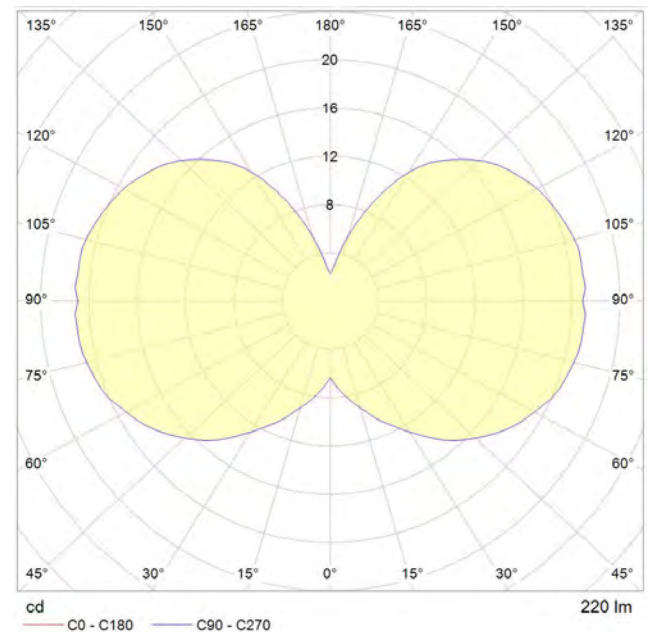

IES/LDT FILE

Available upon request.

EAN UK: 5060400152902



SPHERE I (E27)

SKU: SPHR-G50-4W-2000/2800K-E27-MP

tala

3.8 WATT | 220 LUMENS | 2000K TO 2800K

DIM TO WARM
TECHNOLOGY

Decorative, dim to warm LED lightbulb. This lamp uses 3.8 Watts of power and achieves 220 Lumens at a CRI of 95. It has an IP54 rating.



LAMP

Shape: G50
Materials: Soda-lime Glass and Brass Cap
Finish: Matte White
Beam angle: 360°
Base: E27
Weight: 23g
Working temperature: -5°C to 40°C
Warm up time: Instant
Warranty: 3 years
Input Voltage: 220-240V, 50/60Hz



BULB DIMENSIONS

50 x 84 mm
(Width x Length)

PERFORMANCE

CRI (colour rendering index)	95
Lamp lumen output	252lm
Flicker	<5%
Lumens per circuit watt (LM/W)	58lm/W
Lifetime (TM-21) (hours)	15,000hrs
Colour Temperature	2000K - 2800K
Power factor	0.9

DIMMING

Dimmable: Yes
Dimming type: Leading or trailing edge dimmer
Recommended EU Dimmer: Varilight - V-pro
A full list of compatible dimmers is available on our website:
www.tala.co.uk/recommended-dimmers/

POLAR DIAGRAM

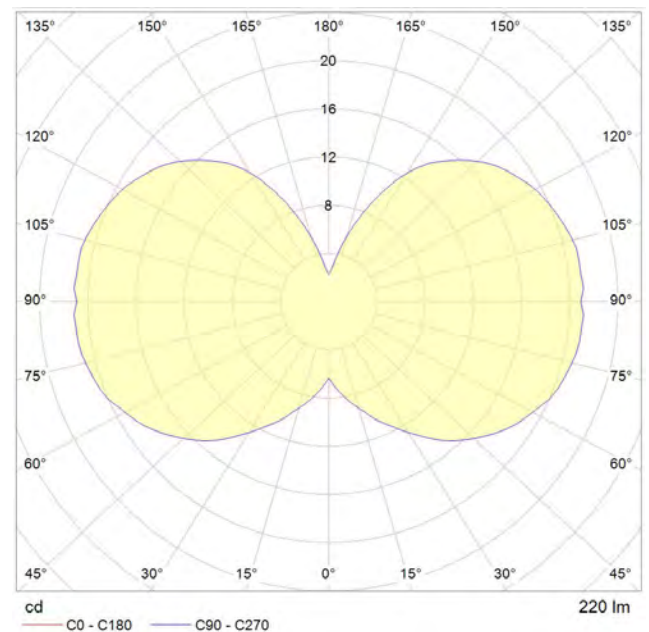

IES/LDT FILE

Available upon request.

EAN UK: 5060400152926



SPHERE II

SKU: SPHR-G75-6W-2000/2800K-E27-MP

tala

6 WATT | 480 LUMENS | 2000K TO 2800K

DIM TO WARM
TECHNOLOGY

Decorative, dim to warm LED light bulb. This lamp uses 6 Watts of power and achieves 480 Lumens at a CRI of 95. It has an IP54 rating.



LAMP

Shape: G75
Materials: Borosilicate Glass and Brass Cap
Finish: Matte White
Beam angle: 360°
Base: E27
Weight: 82g
Working temperature: -5°C to 40°C
Warm up time: Instant
Warranty: 3 years
Input Voltage: 220-240V, 50/60Hz



BULB DIMENSIONS

75 x 112 mm
(Width x Length)

PERFORMANCE

CRI (colour rendering index)	95
Lamp lumen output	480lm
Flicker	<5%
Lumens per circuit watt (LM/W)	80lm/W
Lifetime (TM-21) (hours)	15,000hrs
Colour Temperature	2000K - 2800K
Power factor	0.9

DIMMING

Dimmable: Yes
Dimming type: Leading or trailing edge dimmer
Recommended EU Dimmer: Varilight - V-pro
A full list of compatible dimmers is available on our website:
www.tala.co.uk/recommended-dimmers/

POLAR DIAGRAM

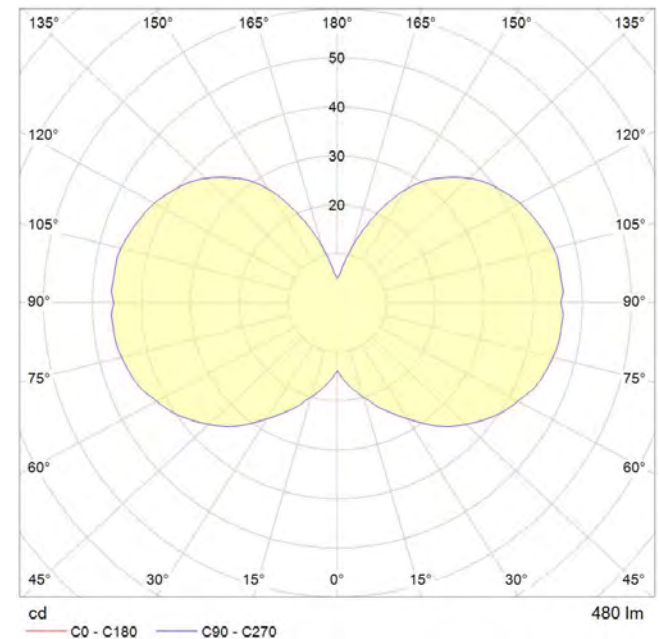

IES/LDT FILE

Available upon request.

EAN UK:5060400152940

IP54



SPHERE III

SKU: SPHR-G100-7W-2000/2800K-E27-MP

tala

7 WATT | 600 LUMENS | 2000K TO 2800K

DIM TO WARM
TECHNOLOGY

Decorative, dim to warm LED light bulb. This lamp uses 7 Watts of power and achieves 600 Lumens at a CRI of 95. It has an IP54 rating.



LAMP

Shape: G100
Materials: Borosilicate Glass and Brass Cap
Finish: Matte White
Beam angle: 360°
Base: E27
Weight: 116g
Working temperature: -5°C to 40°C
Warm up time: Instant
Warranty: 3 years
Input Voltage: 220-240V, 50/60Hz



BULB DIMENSIONS

100 x 137 mm
(Width x Length)

PERFORMANCE

CRI (colour rendering index)	95
Lamp lumen output	600lm
Flicker	<5%
Lumens per circuit watt (LM/W)	86lm/W
Lifetime (TM-21) (hours)	15,000hrs
Colour Temperature	2000K - 2800K
Power factor	0.9

POLAR DIAGRAM

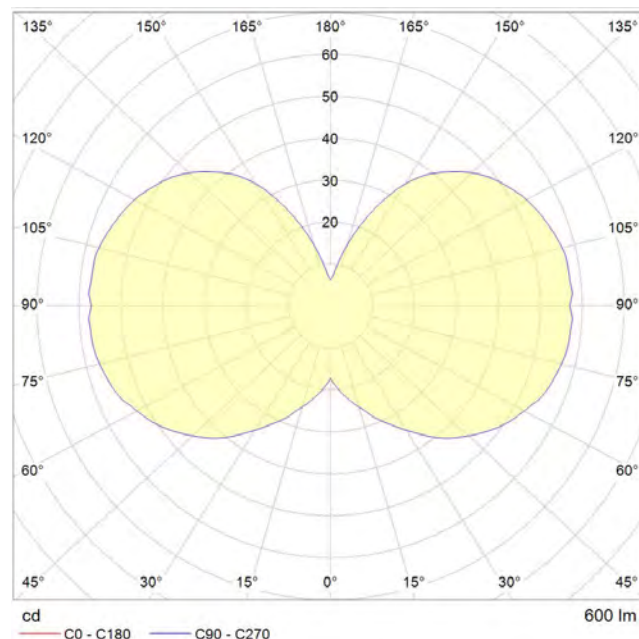

DIMMING

Dimmable: Yes
Dimming type: Leading or trailing edge dimmer
Recommended EU Dimmer: Varilight - V-pro
A full list of compatible dimmers is available on our website:
www.tala.co.uk/recommended-dimmers/

IES/LDT FILE

Available upon request.

EAN UK: 5060400152858

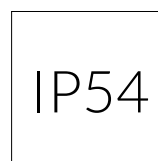

SPHERE IV

SKU: SPHR-G150-8W-2000/2800K-E27-MP

tala

8 WATT | 680 LUMENS | 2000K TO 2800K

DIM TO WARM
TECHNOLOGY

Decorative, dim to warm LED lightbulb. This lamp uses 8 Watts of power and achieves 680 Lumens at a CRI of 95. It has an IP54 rating.



LAMP

Shape: G150
Materials: Borosilicate Glass and Brass Cap
Finish: Matte White
Beam angle: 360°
Base: E27
Weight: 180g
Working temperature: -5°C to 40°C
Warm up time: Instant
Warranty: 3 years
Input Voltage: 220-240V, 50/60Hz



BULB DIMENSIONS

150 x 190 mm
(Width x Length)

PERFORMANCE

CRI (colour rendering index)	95
Lamp lumen output	680lm
Flicker	<5%
Lumens per circuit watt (LM/W)	85lm/W
Lifetime (TM-21) (hours)	15,000hrs
Colour Temperature	2000K - 2800K
Power factor	0.9

DIMMING

Dimmable: Yes
Dimming type: Leading or trailing edge dimmer
Recommended EU Dimmer: Varilight - V-pro
A full list of compatible dimmers is available on our website:
www.tala.co.uk/recommended-dimmers/

POLAR DIAGRAM

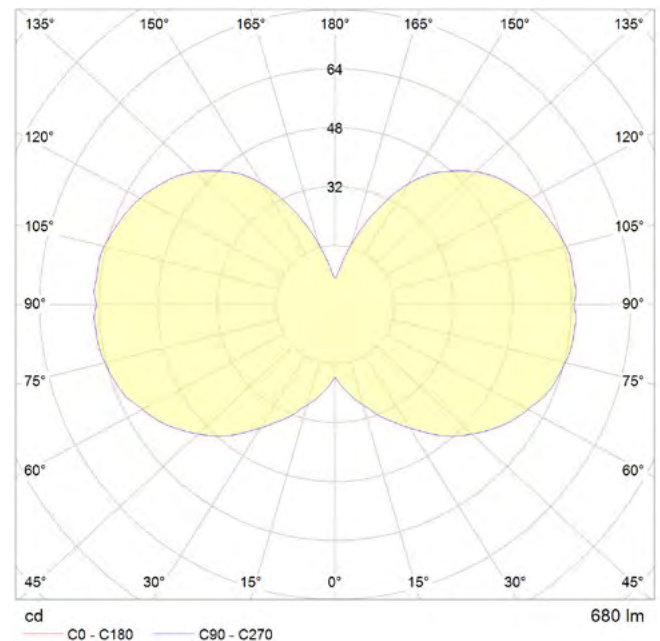

IES/LDT FILE

Available upon request.

EAN UK: 5060400152889



2 WATT | 100 LUMENS | 2200K

Decorative LED filament lamp made of mouth-blown glass. This lamp uses 2 Watts of power and achieves 100 Lumens at a CRI of 95. It has an IP54 rating.

LAMP

Shape: Custom
Materials: Brass cap, mouth-blown glass
Finish: Iron tinted
Beam angle: 360°
Base: E27
Weight: 0.17 kg
Working temperature: -5C to 40C
Warm up time: Instant
Warranty: 3 years
Input Voltage: 220V-240V



BEST PAIRED WITH

1. Brass Pendant
2. Oak Pendant
3. Walnut Pendant



PERFORMANCE

CRI (colour rendering index)	95
Lamp lumen output	100
Luminaire circuits per watt (LM/W)	40
Lifetime (TM-21) (hours)	15,000
Colour Temperature	2200K
Power factor	0.9

POLAR DIAGRAM

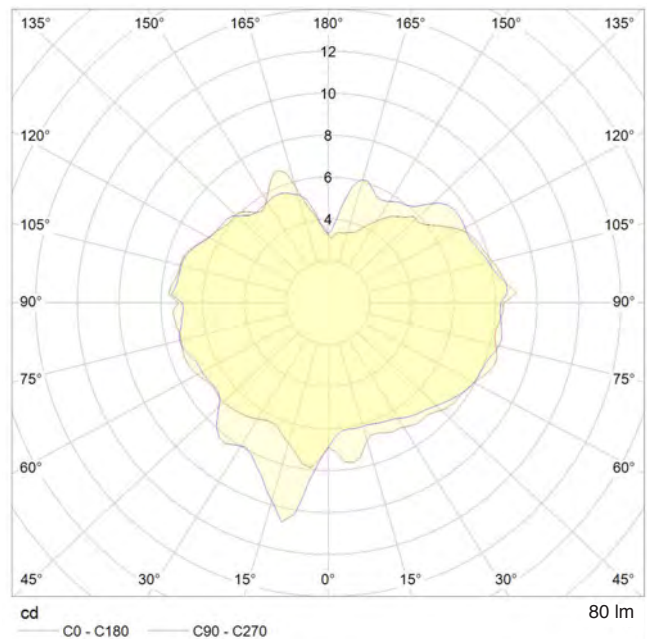

DIMMING

Dimmable: Yes
Dimming type: Trailing edge
Recommended EU Dimmer: Varilight - V-pro JXP401
 (X denotes faceplate color)

A full list of compatible dimmers is available on request.

OUTER CARTON

Pc/ Ctn: 6
Gross weight: 6kg
Length: 63cm
Width: 40cm
Height: 26cm

IES/LDT FILE

Available upon request.

EAN UK: 5060400151875



3 WATT | 150 LUMENS | 2200K

Decorative LED filament lamp made of mouth-blown glass. This lamp uses 3 Watts of power and achieves 150 Lumens at a CRI of 95. It has an IP54 rating.

LAMP

Shape: Custom
Materials: Brass cap, mouth-blown glass
Finish: Iron tinted
Beam angle: 360°
Base: E27
Weight: 0.29 kg
Working temperature: -5C to 40C
Warm up time: Instant
Warranty: 3 years
Input Voltage: 220V-240V



165 mm

300 mm

BEST PAIRED WITH

1. Brass Pendant
2. Oak Pendant
3. Walnut Pendant



PERFORMANCE

CRI (colour rendering index)	95
Lamp lumen output	150
Luminaire circuits per watt (LM/W)	40
Lifetime (TM-21) (hours)	15,000
Colour Temperature	2200K
Power factor	0.9

POLAR DIAGRAM

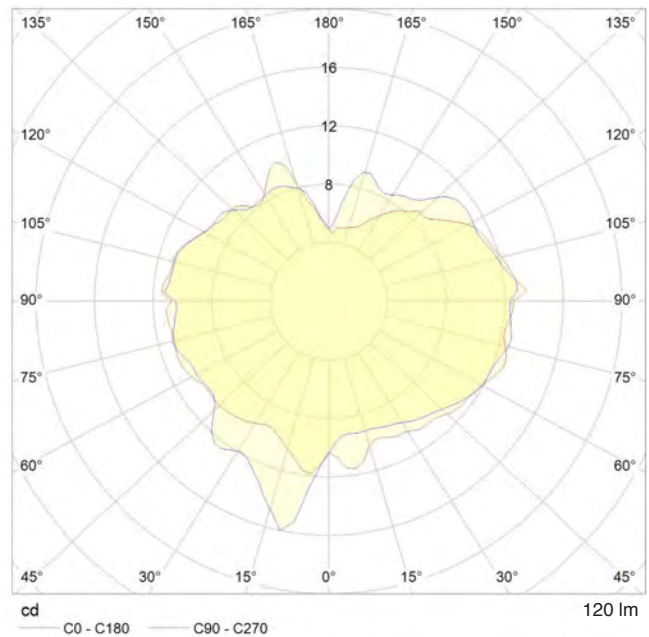

DIMMING

Dimmable: Yes
Dimming type: Trailing edge
Recommended EU Dimmer: Varilight - Vpro JXP401
 (X denotes faceplate color)

A full list of compatible dimmers is available on request.

OUTER CARTON

Pc/ Ctn: 4
Gross weight: 5.2kg
Length: 41cm
Width: 41cm
Height: 37cm

IES/LDT FILE

Available upon request.

EAN UK: 5060400151462



5 WATT | 250 LUMENS | 2200K

Decorative LED filament lamp made of mouth-blown glass. This lamp uses 5 Watts of power and achieves 250 Lumens at a CRI of 95. It has an IP54 rating.

LAMP

- Shape: Custom
- Materials: Brass cap, mouth-blown glass
- Finish: Iron tinted
- Beam angle: 360°
- Base: E27
- Weight: 0.413 kg
- Working temperature: -5C to 40C
- Warm up time: Instant
- Warranty: 3 years
- Input Voltage: 220V-240V



BEST PAIRED WITH

1. Brass Pendant
2. Oak Pendant
3. Walnut Pendant



PERFORMANCE

CRI (colour rendering index)	95
Lamp lumen output	250
Luminaire circuits per watt (LM/W)	44
Lifetime (TM-21) (hours)	15,000
Colour Temperature	2200K
Power factor	0.9

POLAR DIAGRAM

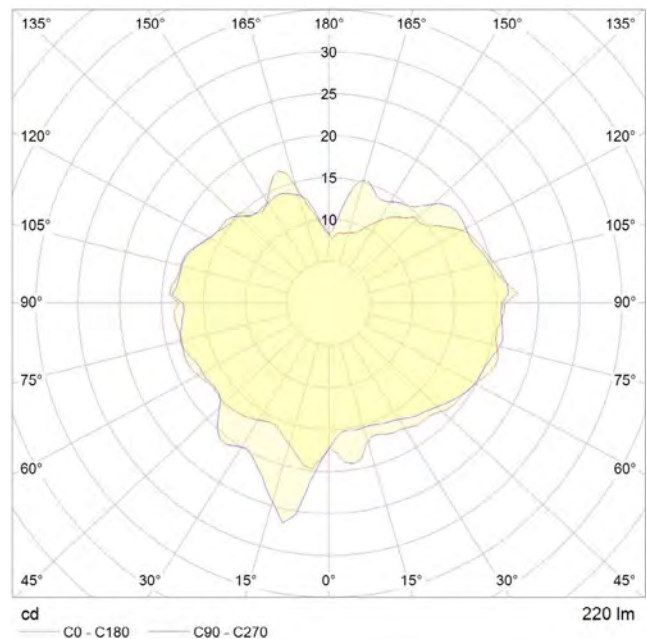

DIMMING

- Dimmable: Yes
- Dimming type: Trailing edge
- Recommended EU Dimmer: Varilight - V-pro JXP401 (X denotes faceplate color)

A full list of compatible dimmers is available on request.

OUTER CARTON

- Pc/ Ctn: 4
- Gross weight: 6.4kg
- Length: 50.5cm
- Width: 44cm
- Height: 50cm

IES/LDT FILE

Available upon request.

EAN UK: 5060400152148



tala[®]

LIGHT ENGINE

Light Engine I

Light Engine II

Light Engine III

LIGHT ENGINE

Leading and trailing edge dimmable Light Engine with Dim to Warm, flicker free, behaviour

I. LIGHT ENGINE I

11 WATT | 1000 LUMENS | 2200K TO 2700K
T30-11W-2200/2700K-E14-SMD

II. LIGHT ENGINE II

22 WATT | 2000 LUMENS | 2200K TO 2700K
T45-22W-2200/2700K-E27-SMD

III. LIGHT ENGINE III

32 WATT | 3000 LUMENS | 2200K TO 2700K
T45-32W-2200/2700K-E27-SMD



	LIGHT ENGINE I	LIGHT ENGINE II	LIGHT ENGINE III
Min. delivered CCT		2200K	
Max. delivered CCT		2700K	
Percent Flicker (IES)		<5%	
Beam angle		~340°	
Dimmable		Dim to Warm	
Lumen Maintenance*		30,000hrs (L70B50)	
Working ambient temp*		-10° to 55°	
Switch cycles		30,000	
Warm-up time		Instant	
Input frequency		50/60Hz	
Input Voltage		220-240V	
Power Factor		0.95	

*refer to Light Engine operating conditions

CRI(Ra)	95	93	93
R9	65	60	60
Rated power	11W	22W	32W
Efficiency (lm/W)	95	95	95
Bulb shape	T30	T45	T45
Base cap	E14	E27	E27
Weight	62g	180g	255g
Dimensions (ø x L mm)	30 x 104	44 x 146	44 x 220

LUMINOUS INTENSITY DISTRIBUTION DIAGRAM

LIGHT ENGINE I

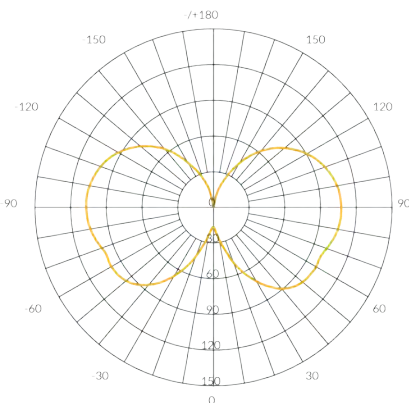

LIGHT ENGINE II

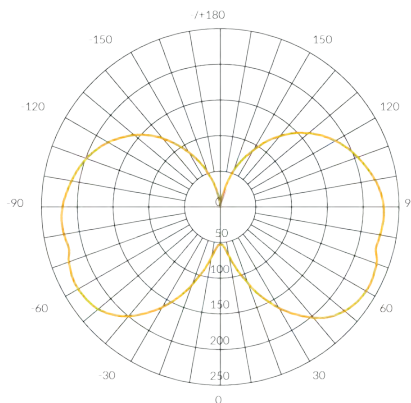

LIGHT ENGINE III

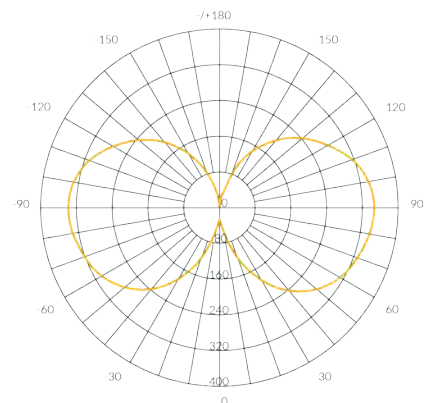

LIGHT ENGINE

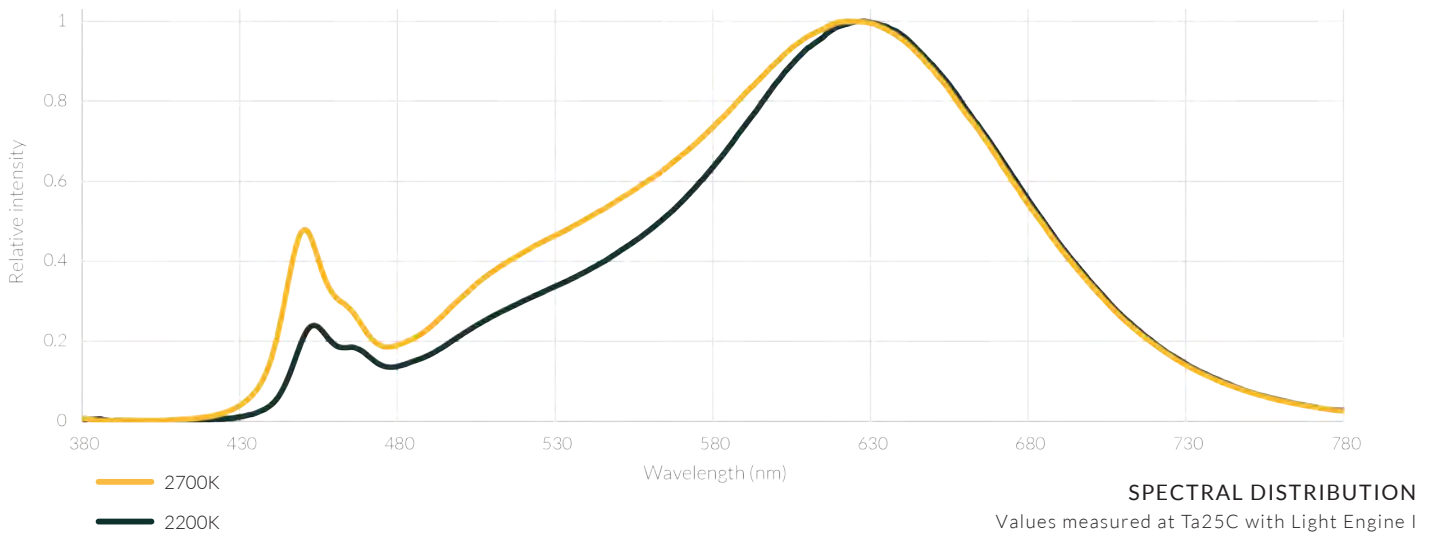
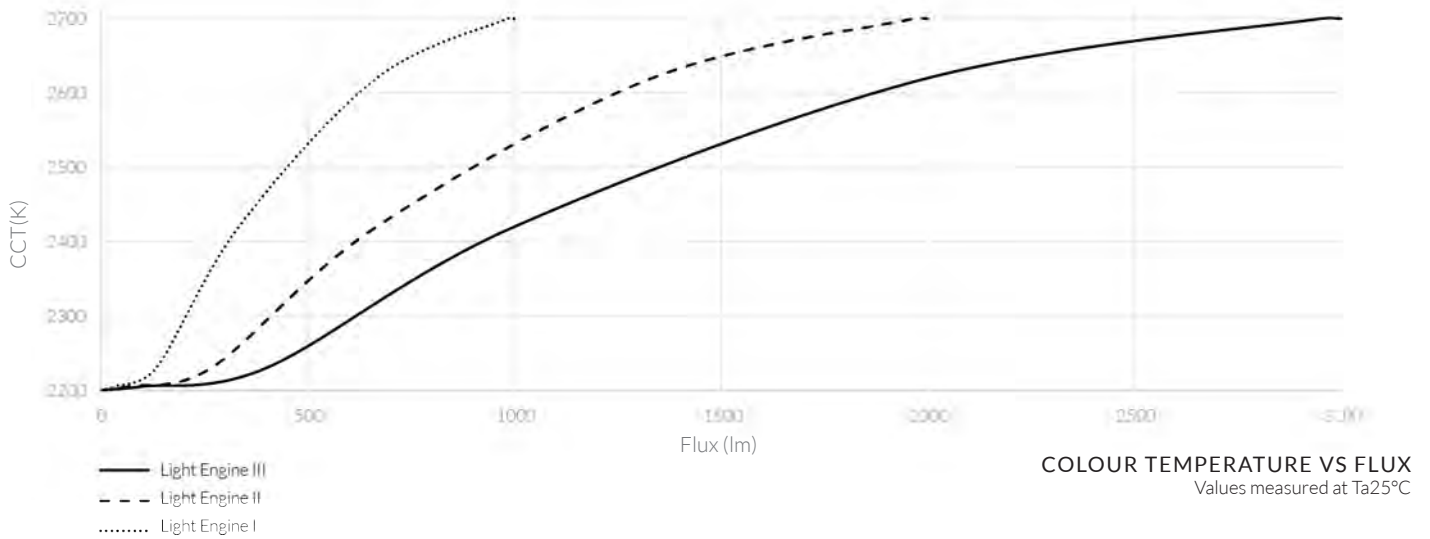

COLOUR QUALITY METRICS

Values measured at Ta25°C with Light Engine I

2700K

2200K

Ra	R1	R2	R3	R4	R5	R6	R7	R8	R9	R10	R11	R12	R13	R14	R15
95	95	98	98	95	96	97	93	85	70	95	96	90	96	99	91
94	96	99	97	95	96	95	90	81	62	98	97	92	97	99	90

IES TM30

COLOUR VECTOR GRAPHIC

This plot shows the average chromaticity shift for the samples within each of 16 hue bins, which are compiled out of the 99 IES TM-30 Color Evaluation Samples. The values are normalized so that the reference is a circle. Vector arrows indicate the direction and degree of the shift for each hue bin.

- Radial shift indicates an increase/decrease in saturation.
- Tangential shift indicates a shift in hue.
- Length of arrow indicates degree of shift.

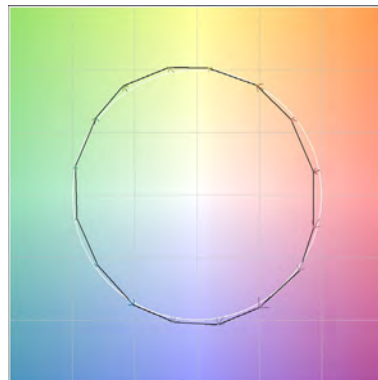

2700K (full power)

Colour fidelity (Rf) 90
Colour Gamut (Rg) 102

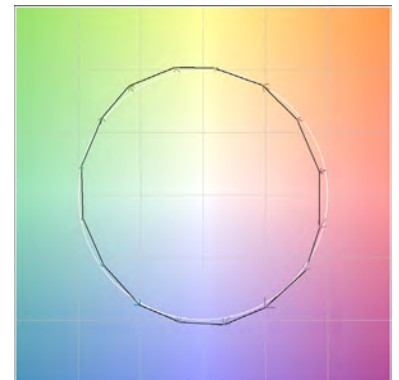

2200K (min power)

Colour fidelity (Rf) 89
Colour Gamut (Rg) 99

LIGHT ENGINE

Recommended Compatible Dimmers

Bticino L4408N/L4410N/L4411N
 Busch-Jaeger- 6523U-102
 Casambi - CBU-TED
 Dmax by Domintell - 420BLE
 Dmax by Domintell - 420SL
 Eltako- EUD61NPN-UC
 Eltako- EUD12NPN
 EPV - Dimmtronic M 1000/3.3

EPV - Dimmtronic PAB 315
 Hamilton - LEDIT-B100
 Kaoyi - KLD100EV1
 Kaoyi - KLD100E4
 Kaoyi - KLD 100EV-F
 Legrand - Universal Dimmer
 Lumex - L T1D450LSWE
 Lutron - RA2 Select

Osram - HTi DALI 315
 Rako - RMT500
 Relco -ART 101
 Relco- RTS 1
 Relco - Snello
 Relco - RT81
 Relco - Rondo
 Vadsbo - LD200

Vadsbo - VD300
 Vadsbo - LDN200
 Varilight - V-Pro
 Vimar -Eikon 20135.1/20136.1
 Wandsworth-WLC IR1x150TD
 Zano - ZBARLED1000

In-situ Temperature Testing

To achieve the best possible performance and ensure the full stated lifetime of the Light Engine, correct thermal design must be practised to ensure the maximum operating temperature of the LEDs and critical components is never exceeded. To ensure compliance it is recommended to undertake In-Situ Temperature Measurement Testing (ISTMT) on each luminaire.

ISTMT can be performed by applying a calibrated thermocouple to the indicated location (Tp) and measuring the maximum steady state temperature at Tp while it is operating in its designed position and or environment. Thermocouples should be bonded to Tp using thermally conductive glue, ideally with direct contact between the thermocouple and the heatsink. A steady state condition can be considered a temperature with less than $\pm 3^{\circ}\text{C}$ of variation over a 15min period.

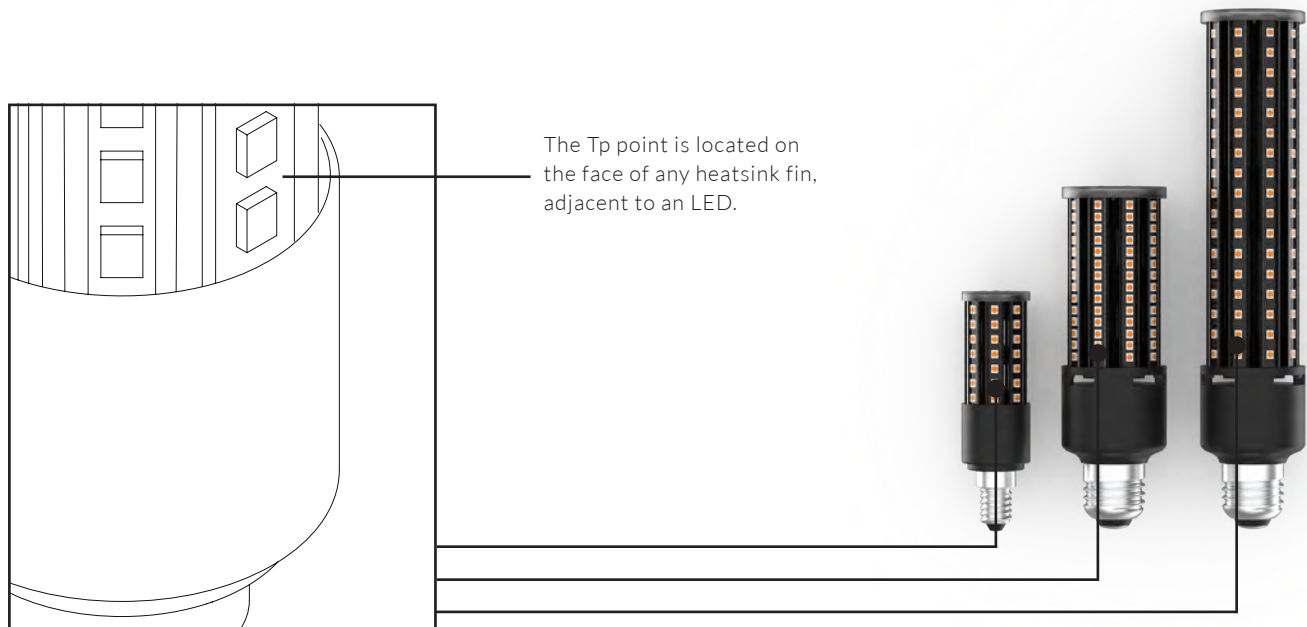

KEY POINTS FOR THERMAL TESTING

- Exceeding the maximum operating temperature of the product will damage the LEDs and internal components, leading to premature failure and voiding the product warranty.
- Maximum operating temperatures are stated in the table below.
- Measure the temperature at the indicated location (Tp).
- Use calibrated thermocouples, bonded directly onto Tp using appropriate thermally conductive glue.
- Perform the test in its designed position and or environment.
- Record the maximum steady state temperature as defined above.

RECOMMENDATIONS FOR CORRECT THERMAL DESIGN

- Adequate airflow around the light engine.
- Not clustering engines close together, minimum distance 10cm.
- Keep away from flammable objects or surfaces.
- Follow recommended enclosure sizes below.

Alternatively, these tests can be performed by an ISTMT certified laboratory.

	LIGHT ENGINE I	LIGHT ENGINE II	LIGHT ENGINE III
TEMPERATURE AT TEST POINT T_p MUST NOT EXCEED:	110°C	105°C	95°C

LIGHT ENGINE

Maximum Ambient Air Temperature (T_a)

The size of the intended fixture, enclosure or luminaire and the temperature of the surrounding external ambient air all impact on the operating temperature of the Light Engine. Tala have performed testing with various shapes and sizes of enclosure to determine minimum internal volumes and maximum internal and external ambient air temperatures (T_a). When operating the Light Engine at full power within these enclosure sizes the maximum external ambient air temperature is 40°C. Failure to adhere to the guidelines will lead to premature failure and void the product warranty.

The enclosure sizes below correspond to approximate internal and external ambient air temperatures for each Light Engine when the relevant maximum temperature T_p has been reached. These are offered as a guideline and must not replace In-Situ Temperature Measurement Testing. Different material properties, air flow and Light Engine position within the enclosure will affect actual temperatures offered as a guideline and must not replace In-Situ Temperature Measurement Testing.

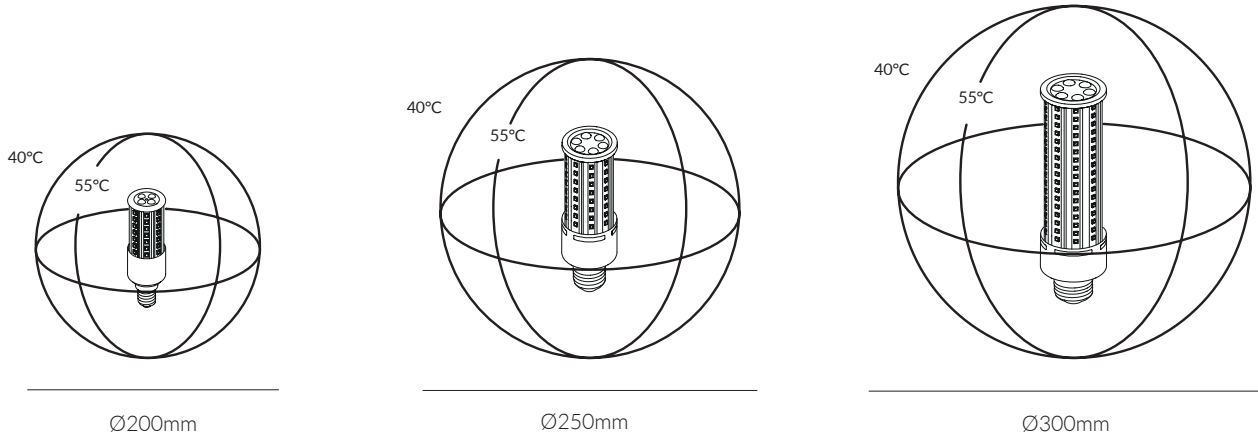

Approximately spherical, thin (1-5mm) glass or plastic diffusers
Max external temperature: 40°C outside diffuser

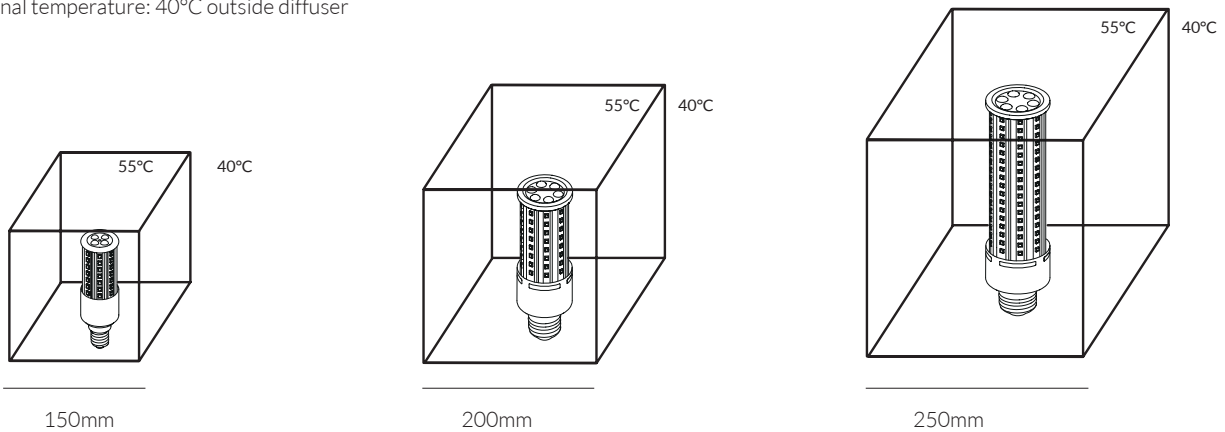

Approximately cubic, thin (1-5mm) glass or plastic diffusers
Max external temperature: 40°C outside diffuser

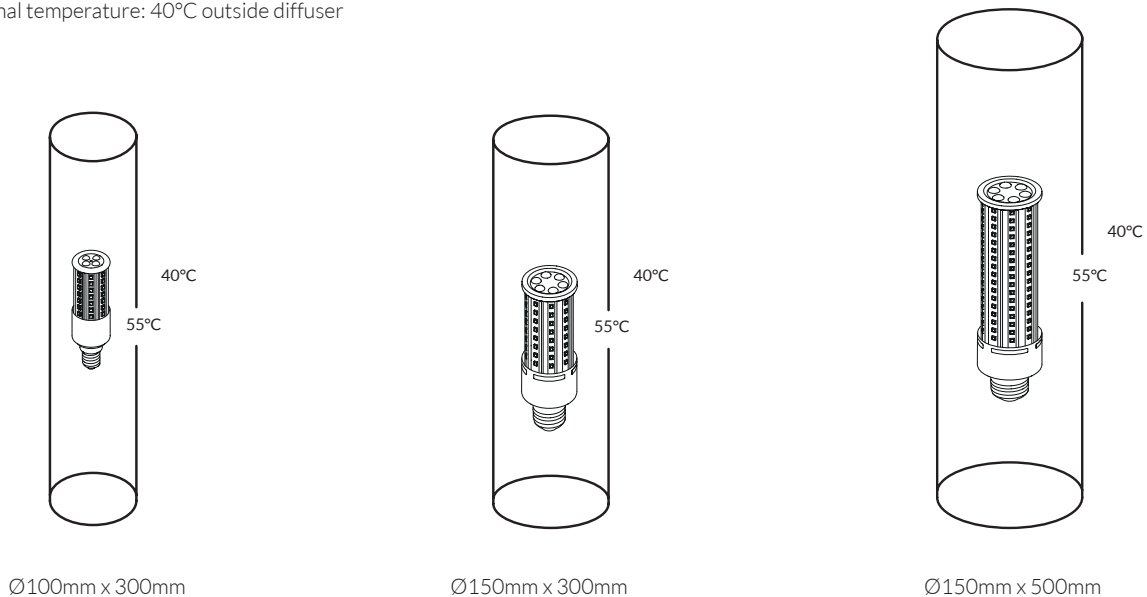

Approximately cylindrical, thin (1-5mm) glass or plastic diffusers
Max external temperature: 40°C outside diffuser

BRASS PENDANT

SKU: BRAS-PD-02

tala®

Fully milled, solid brass pendant with high sheen finish. Fitted with a braided 3 metre black kink free cord, that's easily adjusted by hand. Complete with ceiling rose as standard.

FIXTURE

Type: Pendant
Materials: Brass
Finish: High sheen
Ceiling rose dimensions: 80mm x 25mm
Lampholder: E27
Weight: 0.388 kg
Warranty: 1 year
Input Voltage: 220-240V
Cord: 3 metre cord, Black fabric covered silicone
Luminaire: Class I
Wattage: Max 60 W

Dimmable: Yes



BEST PAIRED WITH

1. Design collection bulbs
2. Feature collection bulbs

OUTER CARTON

Pc/ Ctn: 8
Gross weight: 5.4 kg
Length: 22cm
Width: 44cm
Height: 23.5cm

EAN UK: 5060400151615

IP20



GRAPHITE PENDANT

SKU: GRAP-PD-01

tala®

Anodised aluminium pendant, fitted with a braided 3 metre black kink free cord that's easily adjusted by hand. Complete with ceiling rose as standard.

FIXTURE

Type: Pendant
Materials: Anodised aluminium
Finish: Anodised
Ceiling rose dimensions: 80mm x 25mm
Lampholder: E27
Weight: 0.307 kg
Warranty: 1 year
Input Voltage: 220-240V
Cord: 3 metre cord, Black fabric covered silicone
Luminaire: Class I
Wattage: Max 60 W

Dimmable: Yes



65 mm

40 mm

BEST PAIRED WITH

1. Enno / Noma / Oblo / Oval



OUTER CARTON

Pc/ Ctn: 8
Gross weight: 4.6kg
Length: 22cm
Width: 44cm
Height: 23.5cm

EAN UK: 5060400150564

IP20



OAK KNUCKLE PENDANT

SKU: OAK-KP-02

tala®

FSC-certified hardwood pendant, fitted with a braided 3 metre black kink free cord that's easily adjusted by hand. Complete with ceiling rose as standard.

FIXTURE

Type: Pendant
Materials: Oak & Brass
Finish: Laquered & Brushed
Ceiling rose dimensions: 80mm x 25mm
Lampholder: E27
Weight: 0.360 kg
Warranty: 2 year
Input Voltage: 220-240V
Cord: 3 metre cord, Black fabric covered silicone
Luminaire: Class I
Wattage: Max 60 W

Dimmable: Yes



80 mm

50 mm

BEST PAIRED WITH

1. Enno / Noma / Oblo / Oval
2. Voronoi III



OUTER CARTON

Pc/ Ctn: 8
Gross weight: 5.7kg
Length: 33.5cm
Width: 33.5cm
Height: 23.5cm

EAN UK: 5060400152803

IP20



WALNUT KNUCKLE PENDANT

tala®

SKU: WALT-KP-02

FSC-certified hardwood pendant, fitted with a braided 3 metre black kink free cord that's easily adjusted by hand. Complete with ceiling rose as standard.

FIXTURE

Type: Pendant
Materials: Walnut & Brass
Finish: Laquered & Brushed
Ceiling rose dimensions: 80mm x 25mm
Lampholder: E27
Weight: 0.360kg
Warranty: 2 year
Input Voltage: 220-240V
Cord: 3 metre cord, Black fabric covered silicone
Luminaire: Class I
Wattage: Max 60 W

Dimmable: Yes



80 mm

50 mm

BEST PAIRED WITH

1. Enno / Noma / Oblo / Oval
2. Voronoi III



OUTER CARTON

Pc/ Ctn: 8
Gross weight: 5.7kg
Length: 33.5cm
Width: 33.5cm
Height: 23.5cm

EAN UK: 5060400152827

IP20



BRASS FINISH

PLUG-IN PENDANT (UK-EU)

The Plug-in Pendant by Tala is a portable light feature that is easy on the eye and effortless to install. Complete with extra-long cable, stylish wall and ceiling nodes and in-line dimmer.

Pair with any Tala E27 bulb for optimal dimming performance.

FIXTURE

Type: Plug in Pendant
Materials: Brass
Finish: High sheen
Lampholder: E27
Working temperature: -5°C to 40°C
Warranty: 3 years
Input Voltage: 220-240V
Luminaire: Class II
Max LED Wattage: 25W
Max Incandescent Wattage: 25W



DIMENSIONS:

PENDANT:
40 x 65 mm
(Width x Length)

CORD – PENDANT TO DIMMER:
4m
(Length)

CORD – DIMMER TO PLUG:
2m
(Length)

DIMMING

Dimmable: Yes, in-line dimmer included.
Dimming type: Trailing edge

SKU CODES: EU: BRAS-PAP-01-EU
UK: BRAS-PAP-01-UK

EAN CODES: EU: 5060400158782
UK: 5060400158744

IP20



WHITE / BLACK FINISH

tala®

BRASS TRIPLE PENDANT (UK-EU)

The Brass Triple Pendant by Tala is a stylish lighting system for a variety of interior settings.

Housed in a powder coated steel frame in either white or black finish with three fitted brass grips, three Brass pendants hang at differing lengths for maximum effect. Suitable for any Tala E27 bulb.

FIXTURE

Type: Small Canopy

Materials:

White and Black Powder Coated Steel

Luminaire Class: I

Warranty: 3 years

PENDANT

Materials: Brass

Lampholder: E27

Luminaire Class: II

Working temperature: -5°C to 40°C

Warranty: 1 years

Input Voltage: 220-240V

Max Wattage: 60W



White

Black

DIMENSIONS:

SMALL CANOPY:

250 x 20mm

(Width x Length)

PENDANT:

40 x 65 mm

(Width x Length)

CABLE LENGTH:

3000 mm

(Length)

SKU CODES: WHITE (EU): CP-WHT-SML-BP-01-EU
BLACK (EU): CP-BLK-SML-BP-01-EU

EAN CODES: WHITE (EU): 5060400153879
BLACK (EU): 5060400153916

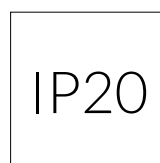

WHITE / BLACK FINISH

tala®

GRAPHITE TRIPLE PENDANT (UK/EU)

The Graphite Triple Pendant by Tala is a stylish lighting system for a variety of interior settings.

Housed in a powder coated steel frame in either white or black finish with three fitted black grips, three Graphite pendants hang at differing lengths for maximum effect. Suitable for any Tala E27 bulb.

FIXTURE

Type: Small Canopy

Materials:

White and Black Powder Coated Steel

Luminaire Class: I

Warranty: 3 years

PENDANT

Materials: Anodised aluminium

Lampholder: E27

Luminaire Class: II

Working temperature: -5°C to 40°C

Warranty: 1 years

Input Voltage: 220-240V

Max Wattage: 60W



White

Black

DIMENSIONS:

SMALL CANOPY:

250 x 20mm
(Width x Length)

PENDANT:

40 x 65 mm
(Width x Length)

CABLE LENGTH:

3000 mm
(Length)

SKU CODES: WHITE (EU): CP-WHT-SML-GP-01-EU
BLACK (EU): CP-BLK-SML-GP-01-EU

EAN CODES: WHITE (EU): 5060400153855
BLACK (EU): 5060400153909



OAK TRIPLE PENDANT (UK-EU)

The Oak Triple Pendant by Tala is a stylish lighting system for a variety of interior settings.

Housed in a powder coated steel frame in either white or black finish with three fitted brass grips, three Walnut pendants hang at differing lengths for maximum effect. Suitable for any Tala E27 bulb.

FIXTURE

Type: Small Canopy

Materials:

White and Black Powder Coated Steel

Luminaire Class: I

Warranty: 3 years

PENDANT

Materials: Oak & Brass

Lampholder: E27

Luminaire Class: II

Working temperature: -5°C to 40°C

Warranty: 2 years

Input Voltage: 220-240V

Max Wattage: 60W



White

Black

DIMENSIONS:

SMALL CANOPY:

250 x 20mm
(Width x Length)

PENDANT:

50 x 85 mm
(Width x Length)

CABLE LENGTH:

3000 mm
(Length)

SKU CODES: WHITE (EU): CP-WHT-SML-OP-01-EU
BLACK (EU): CP-BLK-SML-OP-01-EU

EAN CODES: WHITE (EU): 5060400153886
BLACK (EU): 5060400153923

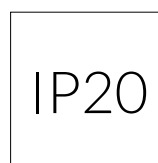

WHITE / BLACK FINISH

tala®

WALNUT TRIPLE PENDANT (UK-EU)

The Walnut Triple Pendant by Tala is a stylish lighting system for a variety of interior settings.

Encased in a circular metal canopy in a white finish, the Walnut wood plate and three Brass grips provide a practical support for three Walnut hanging pendants. Suitable for any Tala E27 bulbs.

FIXTURE

Type: Small Canopy

Materials:

White and Black Powder Coated Steel

Luminaire Class: I

Warranty: 3 years

PENDANT

Materials: Walnut & Brass

Lampholder: E27

Luminaire Class: II

Working temperature: -5°C to 40°C

Warranty: 2 years

Input Voltage: 220-240V

Max Wattage: 60W



White

Black

DIMENSIONS:

SMALL CANOPY:

250 x 20mm
(Width x Length)

PENDANT:

50 x 85 mm
(Width x Length)

CABLE LENGTH:

3000 mm
(Length)

SKU CODES: WHITE (EU): CP-WHT-SML-WP-01-EU
BLACK (EU): CP-BLK-SML-WP-01-EU

EAN CODES: WHITE (EU): 5060400153886
BLACK (EU): 5060400153923

IP20



BRASS NINE PENDANT (UK-EU)

The Brass Nine Pendant by Tala is an impressive lighting system designed for maximum impact.

Housed in a circular metal canopy in a white finish, a broad Brass disc and nine Brass grips create a practical yet attractive base for nine Brass pendants to hang at varying lengths. Suitable for any E27 Tala bulbs.

FIXTURE

Type: Large Canopy

Materials:

White Powder Coated Steel, Brass Plated Steel

Luminaire Class: I

Warranty: 3 years

PENDANT

Materials: Brass

Lampholder: E27

Luminaire Class: II

Working temperature: -5°C to 40°C

Warranty: 1 years

Input Voltage: 220-240V



DIMENSIONS:

LARGE CANOPY:

508 x 50 mm
(Width x Length)

PENDANT:

40 x 65 mm
(Width x Length)

CABLE LENGTH:

5000 mm
(Length)

SKU CODE: CP-WHT-LRG-BP-01-EU

EAN CODE: 5060400156603

IP20



BLACK & ASH FINISH

tala®

GRAPHITE NINE PENDANT (UK-EU)

The Graphite Nine Pendant by Tala is an impressive lighting system designed for maximum impact.

Housed in a circular metal canopy in a black finish, a broad Ash wood disc and nine black grips create a practical yet attractive base for nine Graphite pendants to hang at varying lengths. Suitable for any E27 Tala bulbs.

FIXTURE

Type: Large Canopy

Materials:

Black Powder Coated Steel, Black Stained Ash Veneer

Luminaire Class: I

Warranty: 3 years

PENDANT

Materials: Anodised aluminium

Lampholder: E27

Luminaire Class: II

Working temperature: -5°C to 40°C

Warranty: 1 years

Input Voltage: 220-240V



DIMENSIONS:

LARGE CANOPY:

508 x 50 mm
(Width x Length)

PENDANT:

40 x 65 mm
(Width x Length)

CABLE LENGTH:

5000 mm
(Length)

SKU CODE: CP-BLK-LRG-GP-01-EU

EAN CODE: 5060400156610

IP20



OAK NINE PENDANT (UK-EU)

The Oak Nine Pendant by Tala is an impressive lighting system designed for maximum impact.

Housed in a circular metal canopy in a white finish, a broad Oak disc and nine Brass grips create a practical yet attractive base for nine Oak pendants to hang at varying lengths. Suitable for any E27 Tala bulbs.

FIXTURE

Type: Large Canopy

Materials:

White Powder Coated Steel, Oak Veneer

Luminaire Class: I

Warranty: 3 years

PENDANT

Materials: Oak & Brass

Lampholder: E27

Luminaire Class: II

Working temperature: -5°C to 40°C

Warranty: 1 years

Input Voltage: 220-240V



DIMENSIONS:

LARGE CANOPY:

508 x 50 mm
(Width x Length)

PENDANT:

50 x 85 mm
(Width x Length)

CABLE LENGTH:

5000 mm
(Length)

SKU CODE: CP-WHT-LRG-OP-01-EU

EAN CODE: 5060400156580

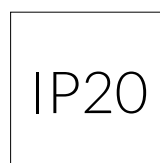

WALNUT NINE PENDANT (UK-EU)

The Walnut Nine Pendant by Tala is an impressive lighting system designed for maximum impact.

Housed in a circular metal canopy in a white finish, a broad Walnut disc and nine Brass grips create a practical yet attractive base for nine Walnut pendants to hang at varying lengths. Suitable for any E27 Tala bulbs.

FIXTURE

Type: Large Canopy

Materials:

White Powder Coated Steel, Walnut Veneer

Luminaire Class: I

Warranty: 3 years

PENDANT

Materials: Walnut & Brass

Lampholder: E27

Luminaire Class: II

Working temperature: -5°C to 40°C

Warranty: 1 years

Input Voltage: 220-240V



DIMENSIONS:

LARGE CANOPY:

508 x 50 mm
(Width x Length)

PENDANT:

50 x 85 mm
(Width x Length)

CABLE LENGTH:

5000 mm
(Length)

SKU CODE: CP-WHT-LRG-WP-01-EU

EAN CODE: 5060400156597

IP20



SOLID BRASS FINISH

5 WATT | 250 LUMENS | 2100K (PER BULB)

SKU CODE: BSALT-I-SET-NON-PD-01-EU

BASALT 9 DROP PENDANT (EU)

Inspired by the thousands of extruded basalt columns that make up the Giant's Causeway in Northern Ireland, Basalt unites translucent mouth-blown borosilicate glass and dimmable LED technology, with a solid brass pendant finish.

LAMP

Shape: Custom

Bulb Materials: Borosilicate Glass and Brass Cap

Bulb Finish: Frosted

Fixture Materials: Sand-casted and polished solid Brass

Beam angle: 360°

Base: E27

Working temperature: -5°C to 40°C

Warm up time: Instant

Warranty: 3 years

Input Voltage: 220-240V



DIMENSIONS:

BULB:

55 x 219 mm (Width x Length)

FIXTURE:

52 x 75 mm (Width x Length)

LARGE CANOPY:

508 x 50 mm (Width x Length)

CABLE:

500cm (Length)

PERFORMANCE (PER BULB)

CRI (colour rendering index)	95
Lamp lumen output	250lm
Flicker	<5%
Lumens per circuit watt (LM/W)	50lm/W
Lifetime (TM-21) (hours)	15,000hrs
Colour Temperature	2100K
Power factor	0.9

POLAR DIAGRAM

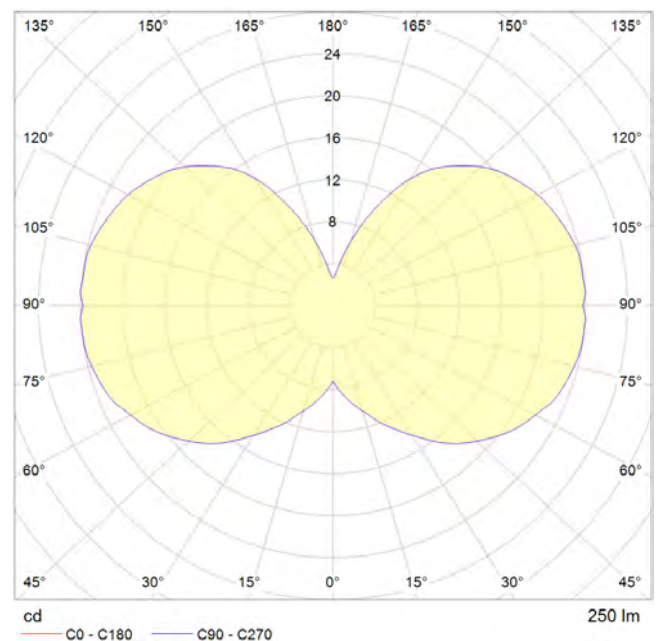

DIMMING

Dimmable: Yes

Dimming type: Trailing edge

Recommended EU Dimmer: Varilight - V-pro

EAN CODE: 5060400157723

IES/LDT FILE: Available upon request.

CANOPY:
IP20

BULBS:
IP54



www.tala.co.uk | hello@tala.co.uk

Specification subject to change without notice. Refer to our website for the most recent product documentation.

STAINLESS STEEL FINISH

5 WATT | 250 LUMENS | 2100K (PER BULB)

SKU CODE: BSALT-I-SET-NON-PD-02-EU

BASALT 9 DROP PENDANT (EU)

Inspired by the thousands of extruded basalt columns that make up the Giant's Causeway in Northern Ireland, Basalt unites mouth-blown borosilicate glass and dimmable LED technology, with a stainless steel pendant finish.

LAMP

Shape: Custom

Bulb Materials: Borosilicate Glass and Brass Cap

Bulb Finish: Frosted

Fixture Materials:

Lost-wax casted and polished Stainless Steel

Beam angle: 360°

Base: E27

Working temperature: -5°C to 40°C

Warm up time: Instant

Warranty: 3 years

Input Voltage: 220-240V



DIMENSIONS:

BULB:

55 x 219 mm (Width x Length)

FIXTURE:

52 x 75 mm (Width x Length)

LARGE CANOPY:

508 x 50 mm (Width x Length)

CABLE:

500cm (Length)

PERFORMANCE (PER BULB)

CRI (colour rendering index)	95
Lamp lumen output	250lm
Flicker	<5%
Lumens per circuit watt (LM/W)	50lm/W
Lifetime (TM-21) (hours)	15,000hrs
Colour Temperature	2100K
Power factor	0.9

POLAR DIAGRAM

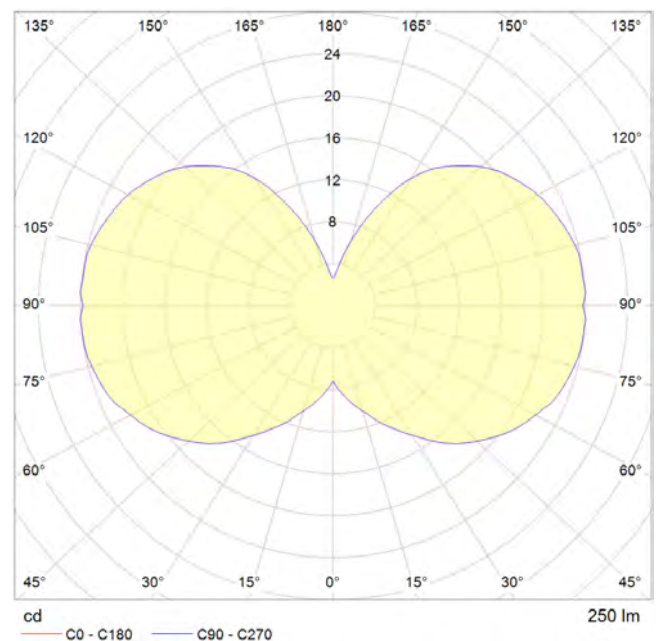

DIMMING

Dimmable: Yes

Dimming type: Trailing edge

Recommended EU Dimmer: Varilight - V-pro

EAN CODE: 5060400157747

IES/LDT FILE: Available upon request.

CANOPY:
IP20

BULBS:
IP54



www.tala.co.uk | hello@tala.co.uk

Specification subject to change without notice. Refer to our website for the most recent product documentation.

SOLID BRASS FINISH

5 WATT | 250 LUMENS | 2100K (PER BULB)

SKU CODE: BSALT-I-SET-TRI-PD-01-EU

BASALT 3 DROP PENDANT (EU)

Inspired by the thousands of extruded basalt columns that make up the Giant's Causeway in Northern Ireland, Basalt unites translucent mouth-blown borosilicate glass and dimmable LED technology, with a solid brass pendant finish.

LAMP

Shape: Custom

Bulb Materials: Borosilicate Glass and Brass Cap

Bulb Finish: Frosted

Fixture Materials: Sand-casted and polished solid Brass

Beam angle: 360°

Base: E27

Working temperature: -5°C to 40°C

Warm up time: Instant

Warranty: 3 years

Input Voltage: 220-240V



DIMENSIONS:

BULB:

55 x 219 mm (Width x Length)

FIXTURE:

52 x 75 mm (Width x Length)

SMALL CANOPY:

250 x 20 mm (Width x Length)

CABLE:

400cm (Length)

PERFORMANCE (PER BULB)

CRI (colour rendering index)	95
Lamp lumen output	250lm
Flicker	<5%
Lumens per circuit watt (LM/W)	50lm/W
Lifetime (TM-21) (hours)	15,000hrs
Colour Temperature	2100K
Power factor	0.9

POLAR DIAGRAM

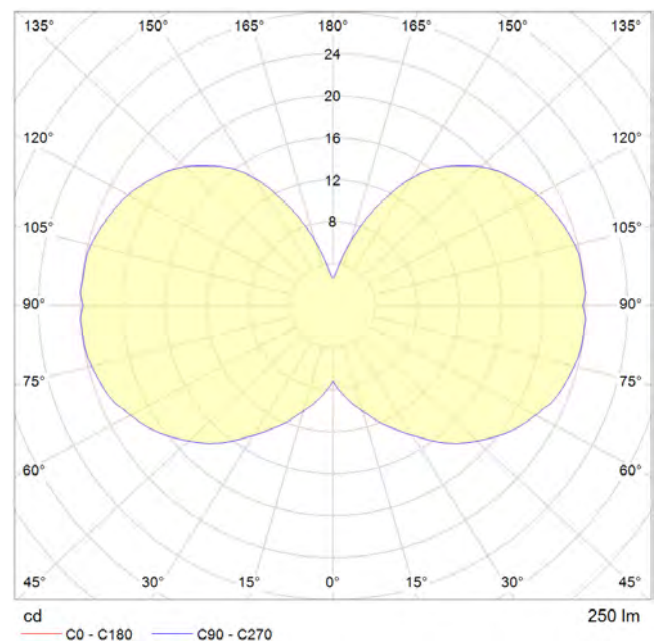

DIMMING

Dimmable: Yes

Dimming type: Trailing edge

Recommended EU Dimmer: Varilight - V-pro

EAN CODE: 5060400156467

IES/LDT FILE: Available upon request.

CANOPY:

IP20

BULBS:

IP54



www.tala.co.uk | hello@tala.co.uk

Specification subject to change without notice. Refer to our website for the most recent product documentation.

SOLID BRASS FINISH

5 WATT | 250 LUMENS | 2100K

SKU CODE: BSALT-I-SET-SGL-PD-01-EU

BASALT SINGLE DROP PENDANT (EU)

Inspired by the thousands of extruded basalt columns that make up the Giant's Causeway in Northern Ireland, Basalt unites translucent mouth-blown borosilicate glass and dimmable LED technology, with a solid brass pendant finish.

LAMP

Shape: Custom

Bulb Materials: Borosilicate glass and Brass base cap

Bulb Finish: Frosted

Fixture Materials: Sand-casted and polished solid Brass

Beam angle: 360°

Base: E27

Working temperature: -5°C to 40°C

Warm up time: Instant

Warranty: 3 years

Input Voltage: 220-240V



DIMENSIONS:

BULB:
55 x 219 mm (Width x Length)

FIXTURE:
52 x 75 mm (Width x Length)

CEILING ROSE:
130 x 25 mm (Width x Length)

CABLE:
300cm (Length)

PERFORMANCE

CRI (colour rendering index)	95
Lamp lumen output	250lm
Flicker	<5%
Lumens per circuit watt (LM/W)	50lm/W
Lifetime (TM-21) (hours)	15,000hrs
Colour Temperature	2100K
Power factor	0.9

POLAR DIAGRAM

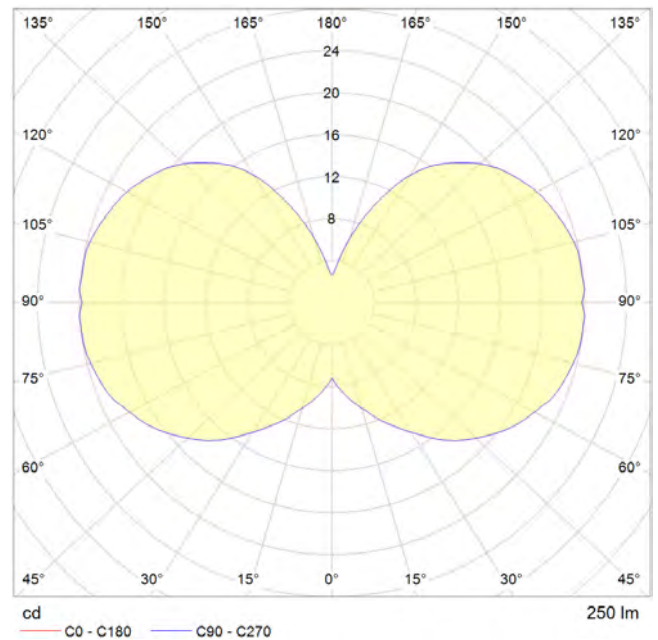

DIMMING

Dimmable: Yes

Dimming type: Trailing edge

Recommended EU Dimmer: Varilight - V-pro

EAN CODE: 5060400156429

IES/LDT FILE: Available upon request.

CANOPY:
IP20

BULBS:
IP54



www.tala.co.uk | hello@tala.co.uk

Specification subject to change without notice. Refer to our website for the most recent product documentation.

STAINLESS STEEL FINISH

5 WATT | 250 LUMENS | 2100K

SKU CODE: BSALT-I-SET-SGL-PD-02-EU

BASALT SINGLE DROP PENDANT (EU)

Inspired by the thousands of extruded basalt columns that make up the Giant's Causeway in Northern Ireland, Basalt unites mouth-blown borosilicate glass and dimmable LED technology, with a stainless steel pendant finish.

LAMP

Shape: Custom

Bulb Materials: Borosilicate glass and Brass base cap

Bulb Finish: Frosted

Fixture Materials:

Lost-wax casted and polished Stainless Steel

Beam angle: 360°

Base: E27

Working temperature: -5°C to 40°C

Warm up time: Instant

Warranty: 3 years

Input Voltage: 220-240V



DIMENSIONS:

BULB:
55 x 219 mm (Width x Length)

FIXTURE:
52 x 75 mm (Width x Length)

CEILING ROSE:
130 x 25 mm (Width x Length)

CABLE:
300cm (Length)

PERFORMANCE

CRI (colour rendering index)	95
Lamp lumen output	250lm
Flicker	<5%
Lumens per circuit watt (LM/W)	50lm/W
Lifetime (TM-21) (hours)	15,000hrs
Colour Temperature	2100K
Power factor	0.9

POLAR DIAGRAM

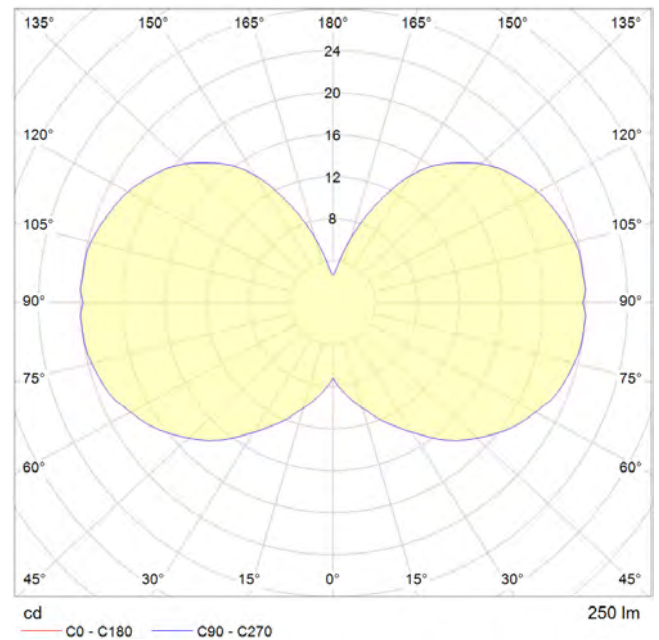

DIMMING

Dimmable: Yes

Dimming type: Trailing edge

Recommended EU Dimmer: Varilight - V-pro

EAN CODE: 5060400156443

IES/LDT FILE: Available upon request.

CANOPY:
IP20

BULBS:
IP54



www.tala.co.uk | hello@tala.co.uk

Specification subject to change without notice. Refer to our website for the most recent product documentation.

STAINLESS STEEL FINISH

5 WATT | 250 LUMENS | 2100K (PER BULB)

SKU CODE: BSALT-I-SET-TRI-PD-02-EU

BASALT 3 DROP PENDANT (EU)

Inspired by the thousands of extruded basalt columns that make up the Giant's Causeway in Northern Ireland, Basalt unites mouth-blown borosilicate glass and dimmable LED technology, with a stainless steel pendant finish.

LAMP

Shape: Custom

Bulb Materials: Borosilicate Glass and Brass Cap

Bulb Finish: Frosted

Fixture Materials:

Lost-wax casted and polished Stainless Steel

Beam angle: 360°

Base: E27

Working temperature: -5°C to 40°C

Warm up time: Instant

Warranty: 3 years

Input Voltage: 220-240V



DIMENSIONS:

BULB:

55 x 219 mm (Width x Length)

FIXTURE:

52 x 75 mm (Width x Length)

SMALL CANOPY:

250 x 20 mm (Width x Length)

CABLE:

400cm (Length)

PERFORMANCE (PER BULB)

CRI (colour rendering index)	95
Lamp lumen output	250lm
Flicker	<5%
Lumens per circuit watt (LM/W)	50lm/W
Lifetime (TM-21) (hours)	15,000hrs
Colour Temperature	2100K
Power factor	0.9

POLAR DIAGRAM

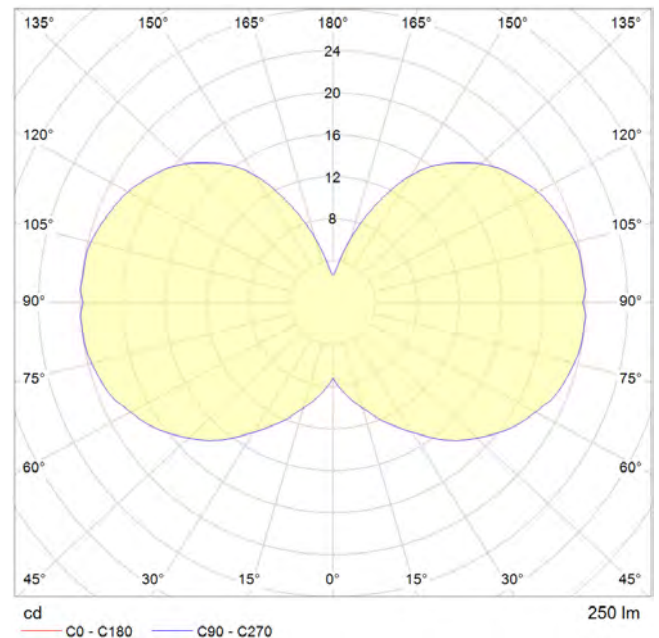

DIMMING

Dimmable: Yes

Dimming type: Trailing edge

Recommended EU Dimmer: Varilight - V-pro

EAN CODE: 5060400156481

IES/LDT FILE: Available upon request.

CANOPY:
IP20

BULBS:
IP54



www.tala.co.uk | hello@tala.co.uk

Specification subject to change without notice. Refer to our website for the most recent product documentation.

WALNUT / OAK FINISH

SKU CODES:

OAK (EU): OAK-KT-01-EU

OAK (UK): OAK-KT-01-UK

WALNUT (EU): WALT-KT-01-EU

WALNUT (UK): WALT-KT-01-UK

KNUCKLE TABLE LAMP (UK-EU)

This elegant table lamp pairs hand-turned, oak and walnut with a satin-brass base to create a timeless fixture for any interior.

The carefully selected in-line dimmer provides maximum dimming performance to illuminate any Tala light source.

FIXTURE

Type: Lamp

Base: E27

Luminaire Class: II

Working temperature: -5°C to 40°C

Warranty: 3 years

Input Voltage: 220-240V

Dimmable: Yes, in-line dimmer included.

Dimming type: Trailing edge

Materials:

Oak and Walnut with a satin-brass base and 3m braided cord.



Oak

Walnut

DIMENSIONS:

FIXTURE:

85 x 123 mm
(Width x Length)

CABLE LENGTH:

3000 mm
(Length)

EAN CODES: OAK (EU): 5060400153473
OAK (UK): 5060400153787
WALNUT (EU): 5060400153497
WALNUT (UK): 5060400153794



BLACKENED OAK FINISH

KNUCKLE TABLE LAMP (UK-EU)

This dark and distinctive table lamp pairs a blackened oak cylinder with a muted gun metal base, creating a unique light feature for any interior.

The carefully selected in-line dimmer provides maximum dimming performance to illuminate any Tala light source.

FIXTURE

Type: Lamp

Base: E27

Luminaire Class: II

Working temperature: -5°C to 40°C

Warranty: 3 years

Input Voltage: 220-240V

Dimmable: Yes, in-line dimmer included.

Dimming type: Trailing edge

Materials:

Painted Oak

with a polished gun metal base



DIMENSIONS:

FIXTURE:

85 x 123 mm
(Width x Length)

CABLE LENGTH:

3000 mm
(Length)

SKU CODES: (EU) BLOAK-KT-01-EU
(UK) BLOAK-KT-01-UK

EAN CODE: (EU) 5060400158348
(UK) 5060400158379





ALUMINA LAMP (UK-EU)

Designed for life on the go, the Alumina Lamp is a modern, multi-functional light that can be used as a table lamp or wall sconce, delivering perfect dimming with tactile function.

Built from lightweight aluminium, it is finished in a delicate Blossom pink to complement the matte porcelain Sphere IV LED bulb.

LAMP

Shape: G150
Bulb Materials: Borosilicate Glass and Brass Cap
Bulb Finish: Matte White
Beam angle: 360°
Base: E27
Working temperature: -5°C to 40°C
Warm up time: Instant
Warranty: 3 years
Input Voltage: 220-240V
Fixture Materials:
 Powder Coated Aluminium



DIMENSIONS:

BULB:
 150 x 190 mm
 (Width x Length)

FIXTURE:
 150 x 220 x 220 mm
 (Width x Length x Height)

PERFORMANCE

CRI (colour rendering index)	95
Lamp lumen output	680lm
Flicker	<5%
Lumens per circuit watt (LM/W)	85lm/W
Lifetime (TM-21) (hours)	15,000hrs
Colour Temperature	2000K - 2800K
Power factor	0.8

POLAR DIAGRAM

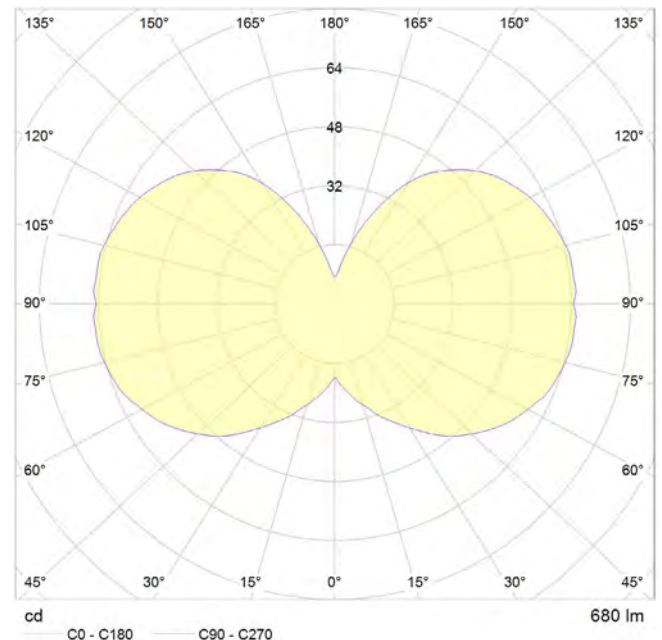

DIMMING

Dimmable: Yes, in-line dimmer included.
Dimming type: Trailing edge

SKU CODES: EU: ALM-SPHR-IV-BLS-TBL-01-EU
 UK: ALM-SPHR-IV-BLS-TBL-01-UK

EAN CODES: EU: 5060400157679
 UK: 5060400157686

IES/LDT FILE:
 Available upon request.



CHALK FINISH

8 WATT | 640 LUMENS | 2000K TO 2800K

DIM TO WARM
TECHNOLOGY



ALUMINA LAMP (UK-EU)

Designed for life on the go, the Alumina Lamp is a modern, multi-functional light that can be used as a table lamp or wall sconce, delivering perfect dimming with tactile function.

Built from lightweight aluminium, it is finished in a subtle Chalk white to match the accompanying matte porcelain Sphere IV LED bulb.

LAMP

Shape: G150
Bulb Materials: Borosilicate Glass and Brass Cap
Bulb Finish: Matte White
Beam angle: 360°
Base: E27
Working temperature: -5°C to 40°C
Warm up time: Instant
Warranty: 3 years
Input Voltage: 220-240V
Fixture Materials:
Powder Coated Aluminium



DIMENSIONS:

BULB:
150 x 190 mm
(Width x Length)

FIXTURE:
150 x 220 x 220 mm
(Width x Length x Height)

PERFORMANCE

CRI (colour rendering index)	95
Lamp lumen output	680lm
Flicker	<5%
Lumens per circuit watt (LM/W)	85lm/W
Lifetime (TM-21) (hours)	15,000hrs
Colour Temperature	2000K - 2800K
Power factor	0.8

POLAR DIAGRAM

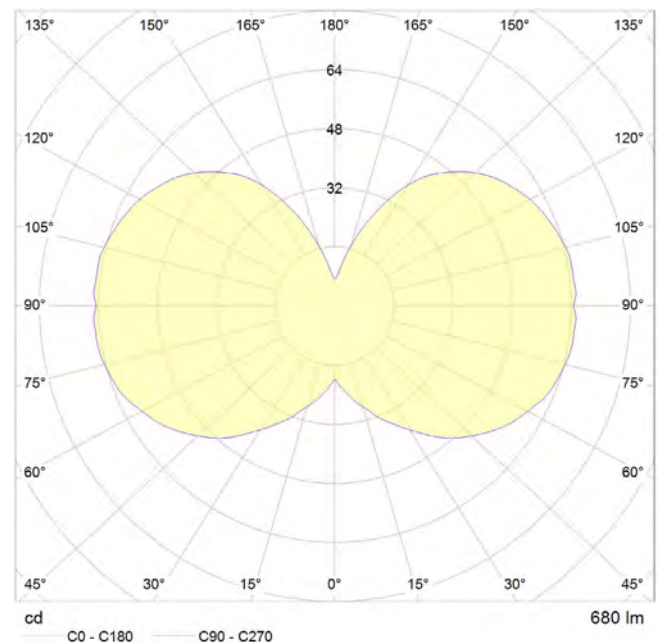

DIMMING

Dimmable: Yes, in-line dimmer included.
Dimming type: Trailing edge

SKU CODES: EU: ALM-SPHR-IV-CHK-TBL-01-EU
UK: ALM-SPHR-IV-CHK-TBL-01-UK

EAN CODES: EU: 5060400157617
UK: 5060400157624

IES/LDT FILE:
Available upon request.

IP20



www.tala.co.uk | hello@tala.co.uk

Specification subject to change without notice. Refer to our website for the most recent product documentation.



ALUMINA LAMP (UK-EU)

Designed for life on the go, the Alumina Lamp is a modern, multi-functional light that can be used as a table lamp or wall sconce, delivering perfect dimming with tactile function.

Built from lightweight aluminium, it is finished in sophisticated Charcoal black to contrast with the accompanying matte porcelain Sphere IV LED bulb.

LAMP

Shape: G150
Bulb Materials: Borosilicate Glass and Brass Cap
Bulb Finish: Matte White
Beam angle: 360°
Base: E27
Working temperature: -5°C to 40°C
Warm up time: Instant
Warranty: 3 years
Input Voltage: 220-240V
Fixture Materials:
 Powder Coated Aluminium



DIMENSIONS:

BULB:
 150 x 190 mm
 (Width x Length)

FIXTURE:
 150 x 220 x 220 mm
 (Width x Length x Height)

PERFORMANCE

CRI (colour rendering index)	95
Lamp lumen output	680lm
Flicker	<5%
Lumens per circuit watt (LM/W)	85lm/W
Lifetime (TM-21) (hours)	15,000hrs
Colour Temperature	2000K - 2800K
Power factor	0.8

POLAR DIAGRAM

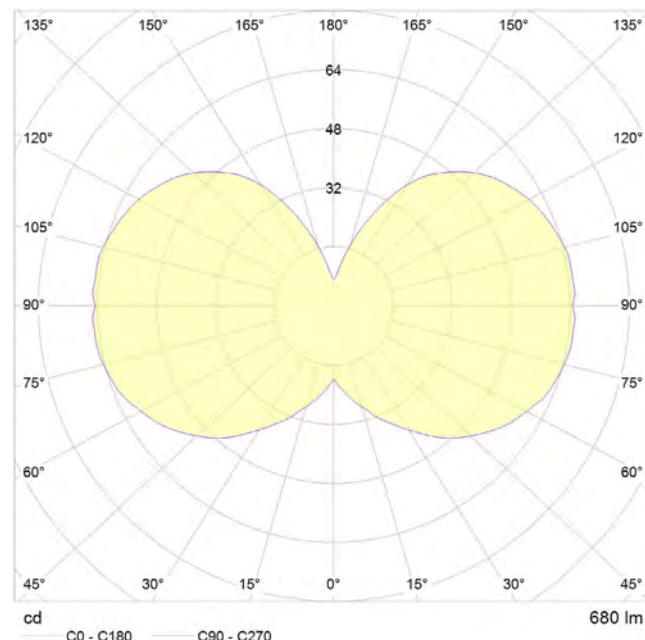

DIMMING

Dimmable: Yes, in-line dimmer included.
Dimming type: Trailing edge

SKU CODES: EU: ALM-SPHR-IV-CHR-TBL-01-EU
 UK: ALM-SPHR-IV-CHR-TBL-01-UK

EAN CODES: EU: 5060400157587
 UK: 5060400157594

IES/LDT FILE:
 Available upon request.

IP20





ALUMINA LAMP (UK-EU)

Designed for life on the go, the Alumina Lamp is a modern, multi-functional light that can be used as a table lamp or wall sconce, delivering perfect dimming with tactile function.

Built from lightweight aluminium, it is finished in a striking Sapphire blue to complement the matte porcelain Sphere IV LED bulb.

LAMP

Shape: G150
Bulb Materials: Borosilicate Glass and Brass Cap
Bulb Finish: Matte White
Beam angle: 360°
Base: E27
Working temperature: -5°C to 40°C
Warm up time: Instant
Warranty: 3 years
Input Voltage: 220-240V
Fixture Materials:
 Powder Coated Aluminium



DIMENSIONS:

BULB:
 150 x 190 mm
 (Width x Length)

FIXTURE:
 150 x 220 x 220 mm
 (Width x Length x Height)

PERFORMANCE

CRI (colour rendering index)	95
Lamp lumen output	680lm
Flicker	<5%
Lumens per circuit watt (LM/W)	85lm/W
Lifetime (TM-21) (hours)	15,000hrs
Colour Temperature	2000K - 2800K
Power factor	0.8

POLAR DIAGRAM

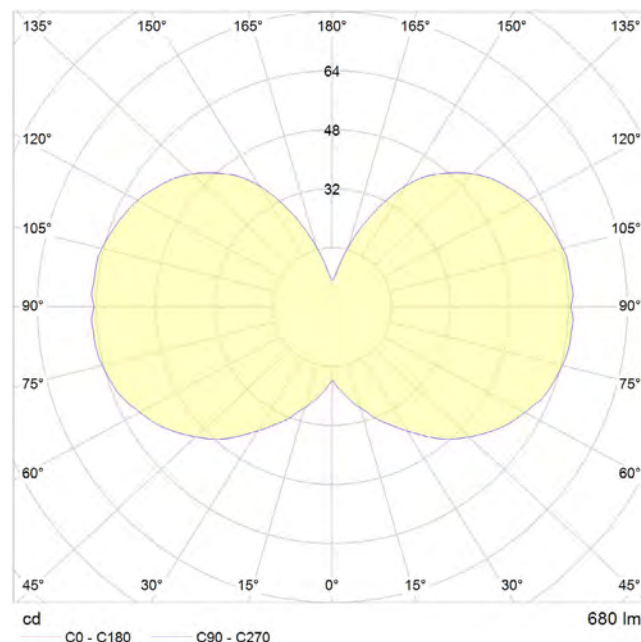

DIMMING

Dimmable: Yes, in-line dimmer included.

Dimming type: Trailing edge

SKU CODES: EU: ALM-SPHR-IV-SAP-TBL-01-EU
 UK: ALM-SPHR-IV-SAP-TBL-01-UK

IES/LDT FILE:
 Available upon request.

EAN CODES: EU: 5060400158430
 UK: 5060400158447

IP20





ALUMINA LAMP (UK-EU)

Designed for life on the go, the Alumina Lamp is a modern, multi-functional light that can be used as a table lamp or wall sconce, delivering perfect dimming with tactile function.

Built from lightweight aluminium, it is finished in a soft Sage green to complement the matte porcelain Sphere IV LED bulb.

LAMP

Shape: G150
Bulb Materials: Borosilicate Glass and Brass Cap
Bulb Finish: Matte White
Beam angle: 360°
Base: E27
Working temperature: -5°C to 40°C
Warm up time: Instant
Warranty: 3 years
Input Voltage: 220-240V
Fixture Materials:
 Powder Coated Aluminium



DIMENSIONS:

BULB:
 150 x 190 mm
 (Width x Length)

FIXTURE:
 150 x 220 x 220 mm
 (Width x Length x Height)

PERFORMANCE

CRI (colour rendering index)	95
Lamp lumen output	680lm
Flicker	<5%
Lumens per circuit watt (LM/W)	85lm/W
Lifetime (TM-21) (hours)	15,000hrs
Colour Temperature	2000K - 2800K
Power factor	0.8

POLAR DIAGRAM

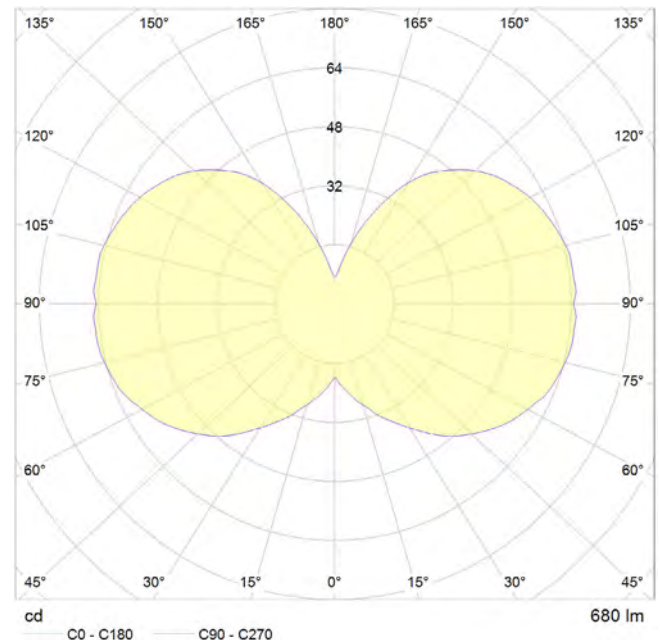

DIMMING

Dimmable: Yes, in-line dimmer included.
Dimming type: Trailing edge

SKU CODES: EU: ALM-SPHR-IV-SGE-TBL-01-EU
 UK: ALM-SPHR-IV-SGE-TBL-01-UK

EAN CODES: EU: 5060400157648
 UK: 5060400157655

IES/LDT FILE:
 Available upon request.

IP20



6 WATT | 540 LUMENS | 2700K

David
Weeks
Studio

REFLECTION ENNO TABLE LAMP (EU/UK)

DAVID WEEKS FOR TALA

tala.

A collaboration with acclaimed New York designer, David Weeks, the Reflection Table Lamps offer playful takes on some of Tala's most celebrated light bulb designs.

Crafted by hand using premium porcelain, the artisanal nature of the products means each piece is unique in texture, color and shape, with no two pieces alike. Any variations or differences in their final form owes to these processes and should not be considered a defect.

LAMP

Shape: Custom
Bulb Materials: Borosilicate Glass and Brass Cap
Bulb Finish: Matte White
Beam angle: 360°
Base: E27
Working temperature: -5°C to 40°C
Warm up time: Instant
Warranty: 3 years
Input Voltage: 220-240V, 50Hz
Fixture Materials: Porcelain



DIMENSIONS

REFLECTION LAMP + BULB
150 x 260cm
(Width x Height)

CABLE LENGTH:
300cm

PERFORMANCE

CRI (colour rendering index)	95
Lamp lumen output	540lm
Flicker	<5%
Lumens per circuit watt (LM/W)	90lm/W
Lifetime (TM-21) (hours)	30,000hrs
Colour Temperature	2700K
Power factor	0.9

POLAR DIAGRAM (BULB)

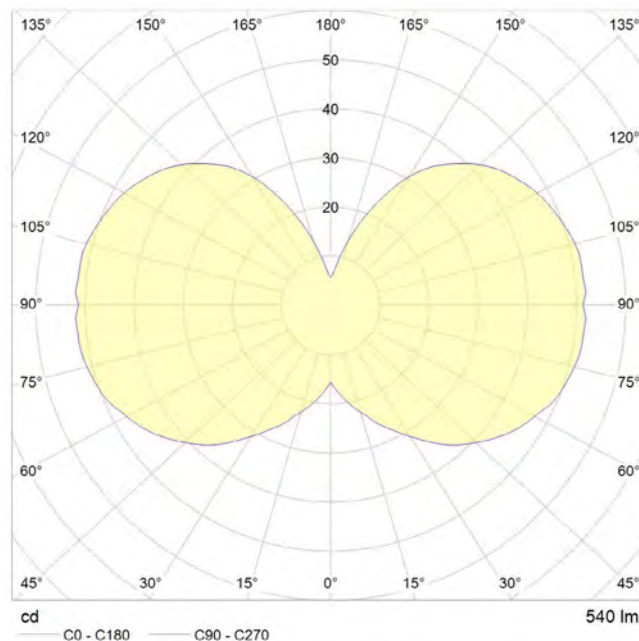

DIMMING

Dimmable: Yes, in-line dimmer included.
Dimming type: Trailing edge
Dimming style: Smooth, silent dimming from 100%-0%

SKU CODES: EU: DWS-ENNO-TBL-01-EU
UK: DWS-ENNO-TBL-01-UK

IES/LDT FILE:
Available upon request.

EAN CODES: EU: 5060400158522
UK: 5060400158485

IP20



www.tala.co.uk | hello@tala.co.uk

Specification subject to change without notice. Refer to our website for the most recent product documentation.

6 WATT | 540 LUMENS | 2700K

David Weeks Studio

REFLECTION NOMA TABLE LAMP (EU/UK)

DAVID WEEKS FOR TALA

tala.

A collaboration with acclaimed New York designer, David Weeks, the Reflection Table Lamps offer playful takes on some of Tala's most celebrated light bulb designs.

Crafted by hand using premium porcelain, the artisanal nature of the products means each piece is unique in texture, color and shape, with no two pieces alike. Any variations or differences in their final form owes to these processes and should not be considered a defect.

LAMP

Shape: Custom
Bulb Materials: Borosilicate Glass and Brass Cap
Bulb Finish: Matte White
Beam angle: 360°
Base: E27
Working temperature: -5°C to 40°C
Warm up time: Instant
Warranty: 3 years
Input Voltage: 220-240V, 50Hz
Fixture Materials: Porcelain



DIMENSIONS

REFLECTION LAMP + BULB
160 x 230cm
(Width x Height)

CABLE LENGTH:
300cm

PERFORMANCE

CRI (colour rendering index)	95
Lamp lumen output	540lm
Flicker	<5%
Lumens per circuit watt (LM/W)	90lm/W
Lifetime (TM-21) (hours)	30,000hrs
Colour Temperature	2700K
Power factor	0.9

POLAR DIAGRAM (BULB)

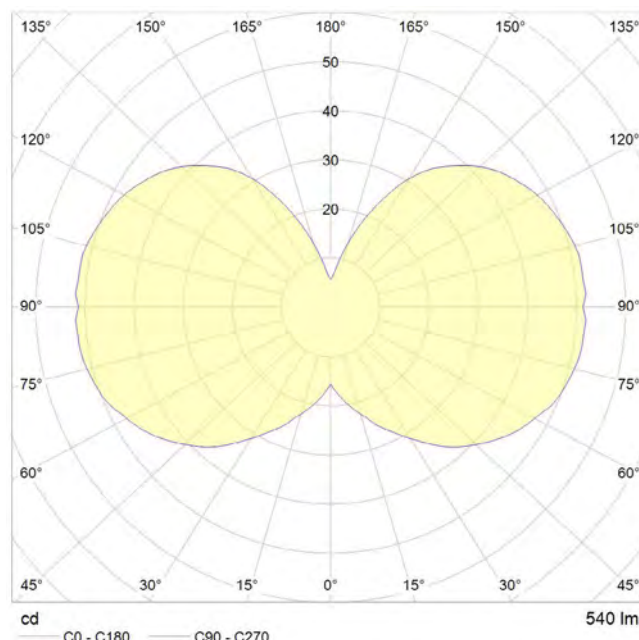

DIMMING

Dimmable: Yes, in-line dimmer included.
Dimming type: Trailing edge
Dimming style: Smooth, silent dimming from 100%-0%

SKU CODES: EU: DWS-NOMA-TBL-01-EU
UK: DWS-NOMA-TBL-01-UK

IES/LDT FILE:
Available upon request.

EAN CODES: EU: 5060400158539
UK: 5060400158492

IP20



www.tala.co.uk | hello@tala.co.uk

Specification subject to change without notice. Refer to our website for the most recent product documentation.

6 WATT | 540 LUMENS | 2700K

David
Weeks
Studio

REFLECTION OBLO TABLE LAMP (EU/UK)

DAVID WEEKS FOR TALA

tala.

A collaboration with acclaimed New York designer, David Weeks, the Reflection Table Lamps offer playful takes on some of Tala's most celebrated light bulb designs.

Crafted by hand using premium porcelain, the artisanal nature of the products means each piece is unique in texture, color and shape, with no two pieces alike. Any variations or differences in their final form owes to these processes and should not be considered a defect.

LAMP

Shape: Custom
Bulb Materials: Borosilicate Glass and Brass Cap
Bulb Finish: Matte White
Beam angle: 360°
Base: E27
Working temperature: -5°C to 40°C
Warm up time: Instant
Warranty: 3 years
Input Voltage: 220-240V, 50Hz
Fixture Materials: Porcelain



DIMENSIONS

REFLECTION LAMP + BULB
160 x 280cm
(Width x Height)

CABLE LENGTH:
300cm

PERFORMANCE

CRI (colour rendering index)	95
Lamp lumen output	540lm
Flicker	<5%
Lumens per circuit watt (LM/W)	90lm/W
Lifetime (TM-21) (hours)	30,000hrs
Colour Temperature	2700K
Power factor	0.9

POLAR DIAGRAM (BULB)

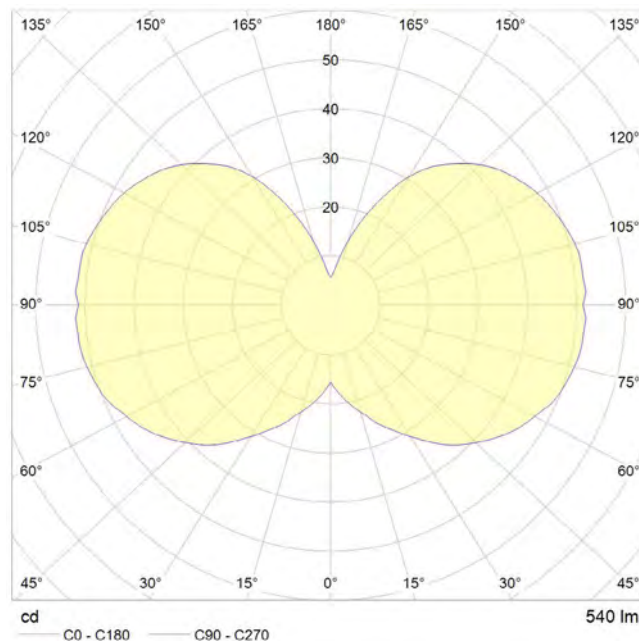

DIMMING

Dimmable: Yes, in-line dimmer included.
Dimming type: Trailing edge
Dimming style: Smooth, silent dimming from 100%-0%

SKU CODES: EU: DWS-OBLO-TBL-01-EU
UK: DWS-OBLO-TBL-01-UK

IES/LDT FILE:
Available upon request.

EAN CODES: EU: 5060400158546
UK: 5060400158508

IP20



www.tala.co.uk | hello@tala.co.uk

Specification subject to change without notice. Refer to our website for the most recent product documentation.

6 WATT | 540 LUMENS | 2700K

David
Weeks
Studio

REFLECTION OVAL TABLE LAMP (EU/UK)

DAVID WEEKS FOR TALA

tala.

A collaboration with acclaimed New York designer, David Weeks, the Reflection Table Lamps offer playful takes on some of Tala's most celebrated light bulb designs.

Crafted by hand using premium porcelain, the artisanal nature of the products means each piece is unique in texture, color and shape, with no two pieces alike. Any variations or differences in their final form owes to these processes and should not be considered a defect.

LAMP

Shape: Custom
Bulb Materials: Borosilicate Glass and Brass Cap
Bulb Finish: Matte White
Beam angle: 360°
Base: E27
Working temperature: -5°C to 40°C
Warm up time: Instant
Warranty: 3 years
Input Voltage: 220-240V, 50Hz
Fixture Materials: Porcelain



DIMENSIONS

REFLECTION LAMP + BULB
190 x 210cm
(Width x Height)

CABLE LENGTH:
300cm

PERFORMANCE

CRI (colour rendering index)	95
Lamp lumen output	540lm
Flicker	<5%
Lumens per circuit watt (LM/W)	90lm/W
Lifetime (TM-21) (hours)	30,000hrs
Colour Temperature	2700K
Power factor	0.9

POLAR DIAGRAM (BULB)

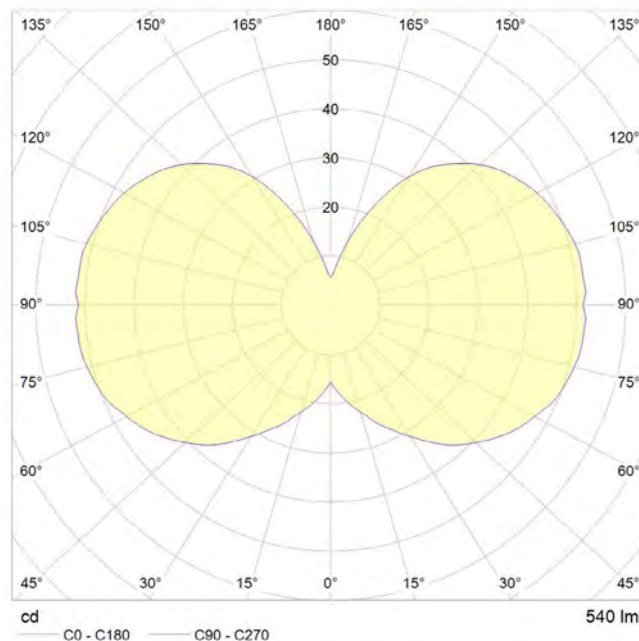

DIMMING

Dimmable: Yes, in-line dimmer included.
Dimming type: Trailing edge
Dimming style: Smooth, silent dimming from 100%-0%

SKU CODES: EU: DWS-OVAL-TBL-01-EU
UK: DWS-OVAL-TBL-01-UK

IES/LDT FILE:
Available upon request.

EAN CODES: EU: 5060400158553
UK: 5060400158515

IP20



www.tala.co.uk | hello@tala.co.uk

Specification subject to change without notice. Refer to our website for the most recent product documentation.

BLACK & ASH FINISH

tala®

LARGE CANOPY (UK-EU)

The Large Canopy by Tala is an impressive modular system designed to create dramatic ceiling light displays.

Housed in a circular metal frame, a broad wooden disc and twelve grips create a practical yet attractive base to hang up to twelve pendants from any ceiling space.

FIXTURE

Type: Large Canopy

Materials:

Black Powder Coated Steel
& Black Stained Ash Veneer

Luminaire Class: I

Warranty: 3 years



DIMENSIONS:

FIXTURE:

508mm x 50mm
(Width x Length)

SKU CODE: CP-ASH-LRG-01-EU

EAN CODE: 5060400156535



WHITE & OAK FINISH

tala®

LARGE CANOPY (UK-EU)

The Large Canopy by Tala is an impressive modular system designed to create dramatic ceiling light displays.

Housed in a circular metal frame, a broad wooden disc and twelve grips create a practical yet attractive base to hang up to twelve pendants from any ceiling space.

FIXTURE

Type: Large Canopy

Materials:

White Powder Coated Steel & Oak Veneer

Luminaire Class: I

Warranty: 3 years



DIMENSIONS:

FIXTURE:

508mm x 50mm

(Width x Length)

SKU CODE: CP-OAK-LRG-01-EU

EAN CODE: 5060400156504

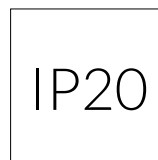

WHITE & WALNUT FINISH

tala®

LARGE CANOPY (UK-EU)

The Large Canopy by Tala is an impressive modular system designed to create dramatic ceiling light displays.

Housed in a circular metal frame, a broad wooden disc and twelve grips create a practical yet attractive base to hang up to twelve pendants from any ceiling space.

FIXTURE

Type: Large Canopy

Materials:

White Powder Coated Steel & Walnut Veneer

Luminaire Class: I

Warranty: 3 years

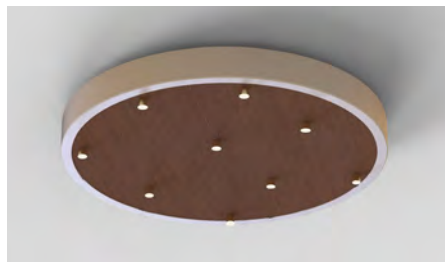

DIMENSIONS:

FIXTURE:

508mm x 50mm
(Width x Length)

SKU CODE: CP-WALT-LRG-01-EU

EAN CODE: 5060400156511

IP20

