

ANTONANGELI CONTEMPORARY DESIGN



ANTONANGELI CONTEMPORARY DESIGN

LA MATERIA E LA LUCE: DALL'INVENZIONE ALL'ARMONIA. MATTER AND LIGHT: FROM INVENTION TO HARMONY.

Antonangeli Illuminazione nasce nel 1977, indirizzando la sua attenzione al design e alla creazione di corpi illuminanti di forte personalità, con la volontà di esprimere un concetto di luce che sia 'funzione' ed 'emozione' contemporaneamente. Nel 2007 Antonangeli entra nel mondo dell'illuminazione esterna con una visione inedita: creare una luce che all'esterno producesse le emozioni e la vivibilità che crea la luce negli interni. Indagando il mercato e seguendo i suggerimenti di una nota paesaggista, Antonangeli dà avvio ad una serie di collezioni 'Outdoor', che ha come motto: 'bisogna rispettare il buio'. La costante coerenza progettuale scaturisce dalla ricerca di soluzioni che non si limitano al semplice progetto formale, all'applicazione delle tecnologie, ma si cimenta con le materie e con i processi di lavorazione. Questo fa di Antonangeli un unicum senza paragoni. Ogni collezione nasce da uno studio approfondito: su materiali nuovi o tradizionali trattati in modo esclusivo, su soluzioni produttive antiche o mai sperimentate. Il risultato sono forme di luce sorprendenti.

Antonangeli Illuminazione was founded in 1977 and immediately directs his attention to the design and creation of lighting with a strong personality: focusing its interest on a concept of light that is 'function' and 'emotion' at the same time. In 2007 enters the Outdoor lighting world – the Outdoor with an unusual view hitherto: creating a light outside that would produce the same emotions and livability that normally creates the light in the interior. Carefully analyzing the market and the proposals and thanks to the suggestions of a landscape architect, Antonangeli gives rise to a serie of 'Outdoor' collections that has as its motto: 'we must respect the dark'. Antonangeli offers solutions which go beyond the simple formal project and technical applications by experimenting with unusual materials which requires special working procedures; at times craft, other times technically highly sophisticated. This alone has made Antonangeli an unicum in his field. he Antonangeli's collections are made of a deep and patient study on traditional materials worked in a new way, new materials as well as productive solutions never before tested in the field of lighting. The result is exciting forms of lighting.

INDOOR COLLECTION

INDICE/INDEX TIPOLOGIA/TIPOLOGY

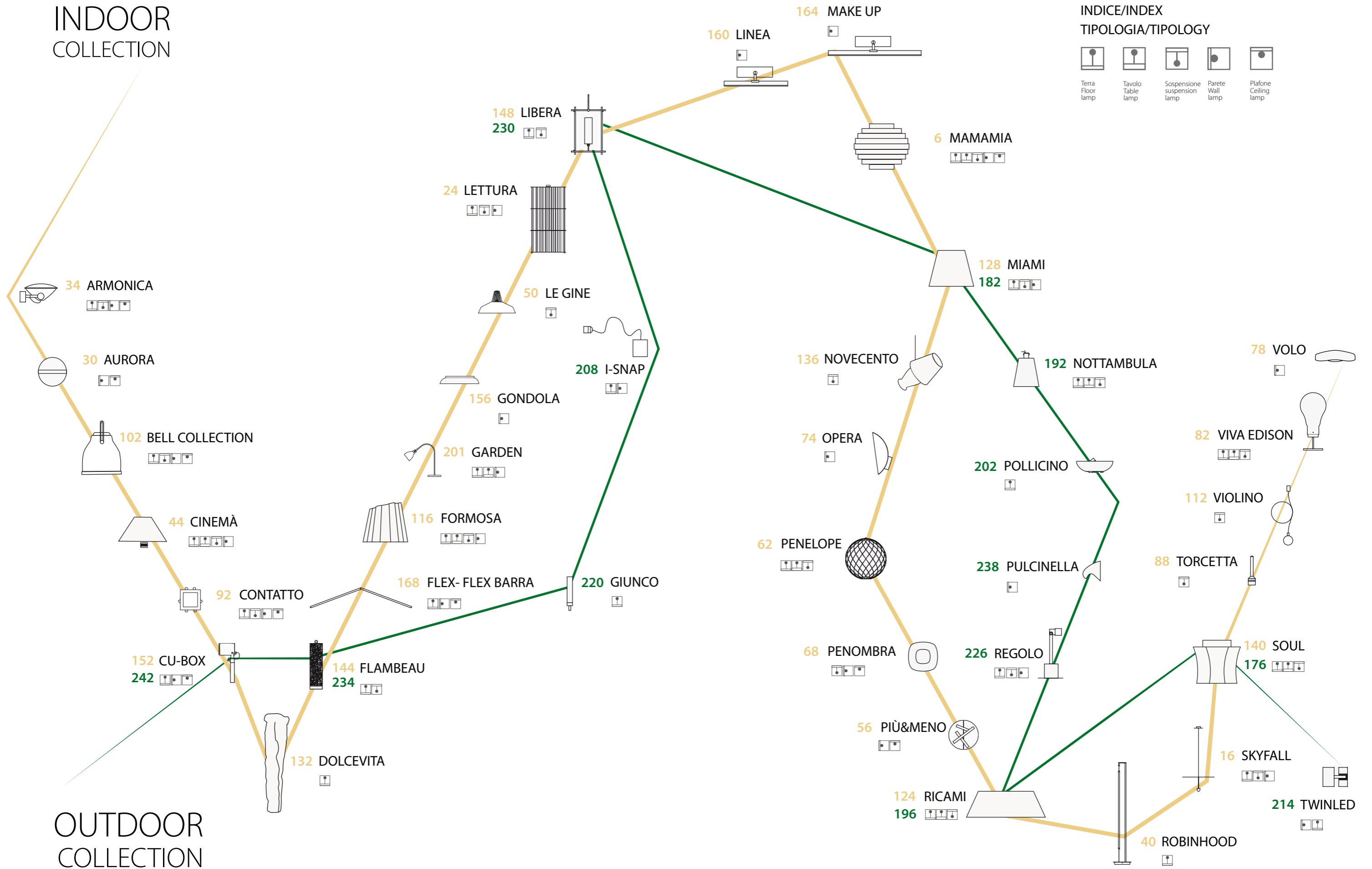
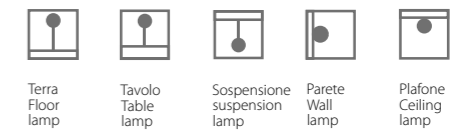

MAMAMIA

design Gianfranco Marabese 2003

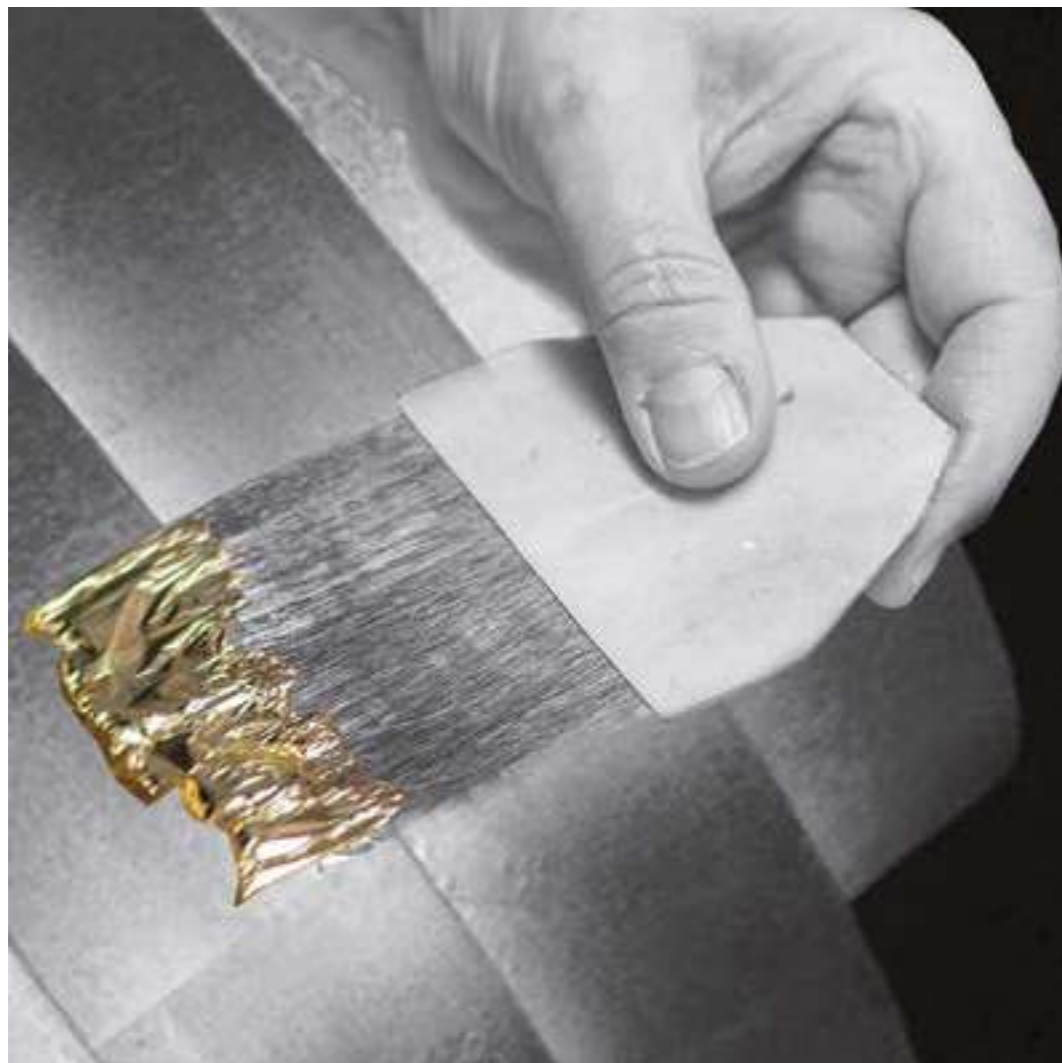

Collezione che riprende ed attualizza formalmente, segni distintivi del design nordico, unendoli ad atmosfere di sapore orientale.

Collection that takes up and updates formally, distinctive signs of Nordic design, combining them with an oriental flavor.









12 Mamamia/Hotel Hilton Green Milan



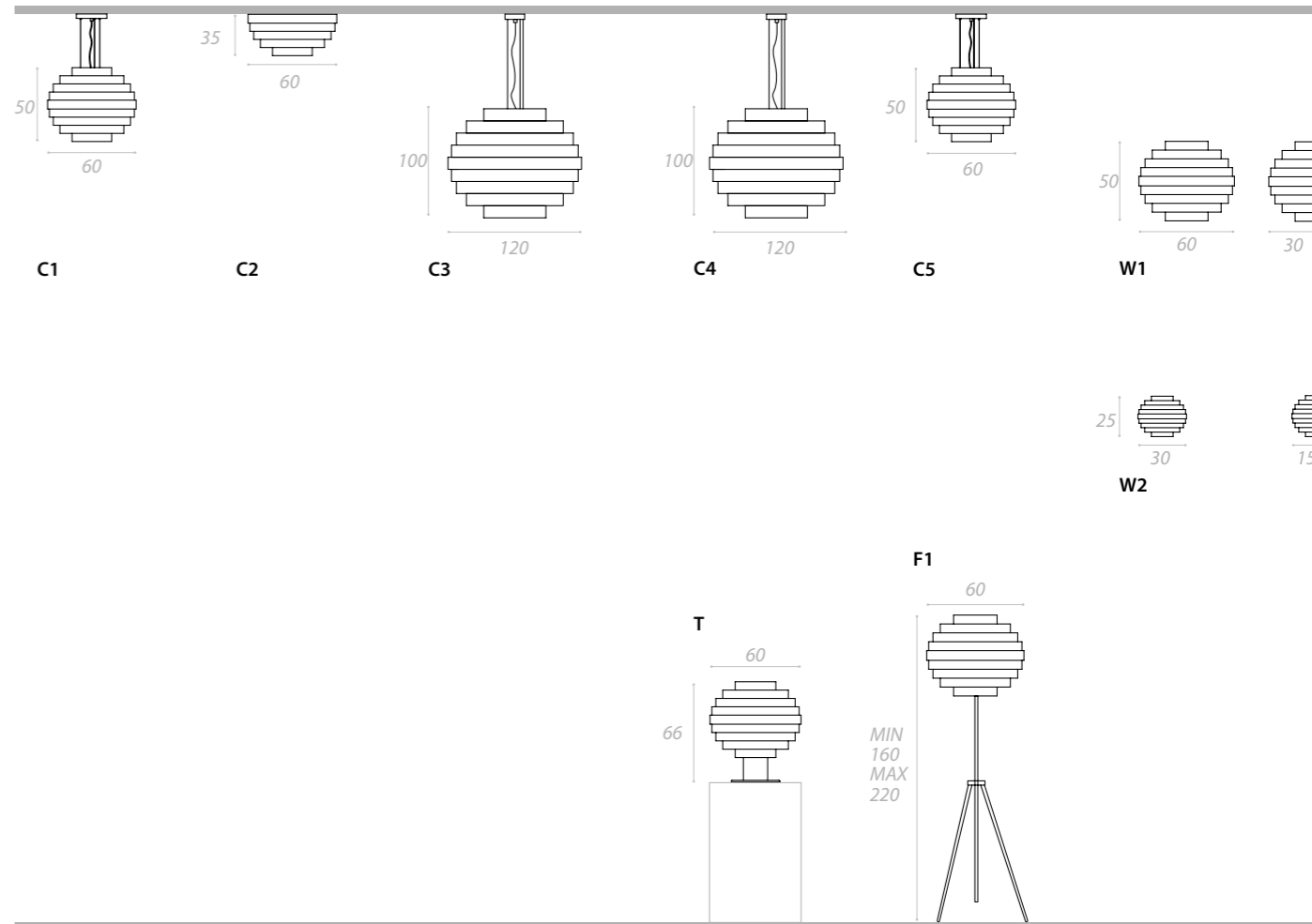

- C1** LED E27 20W 2500lm
 - C2** LED E27 20W 2500lm
 - C3** HQI/CDM E27 70W 6600lm
 - C4** 3x LED E27 20W 2500Lm (7500lm)
 - C5** HQI/CDM E27 70W 6600lm
 - W1** 2x LED E27 20W 2500lm (5000lm)
 - W2** LinearLED R7s 6W 700lm
 - F1** 3x LED E27 20W 2500lm (7500lm)
 - T** LED E27 20W 2500lm
- A+** Dimmer included
A+ Dimmer included
A+
A+ Dimmer included
A+ Dimmer included
A+ Dimmer included
A+ Dimmer included
A+ Dimmer included
A+ Dimmer included
A+ Dimmer included

W1/W2/C1/C2/C3/C4/C5
 F1/T

MATERIALE: metallo/
MATERIAL: metal

- NERO ALLUMINIO/
BLACK ALUMINIUM
- BRONZO FOGLIA RAME/
BRONZE COPPER LIEF
- FOGLIA RAME/ COPPER LIEF
- FOGLIA ARGENTO/ SILVER LIEF
- FOGLIA ORO/ GOLD LIEF
- ALLUMINIO/ ALUMINIUM
- BIANCO/ WHITE

SKYFALL

design Gianfranco Marabese 2016



Collezione di lampade con diffusore realizzato in lamiera di ottone, lavorata secondo l'antica arte della battitura a mano, che rende pregiata la superficie del disco riflettente, carico di vibrazioni uniche.

Lamp collection with diffuser made in handmade hammered brass plate, which makes the surface of the reflecting disc precious, loaded with unique vibrations.







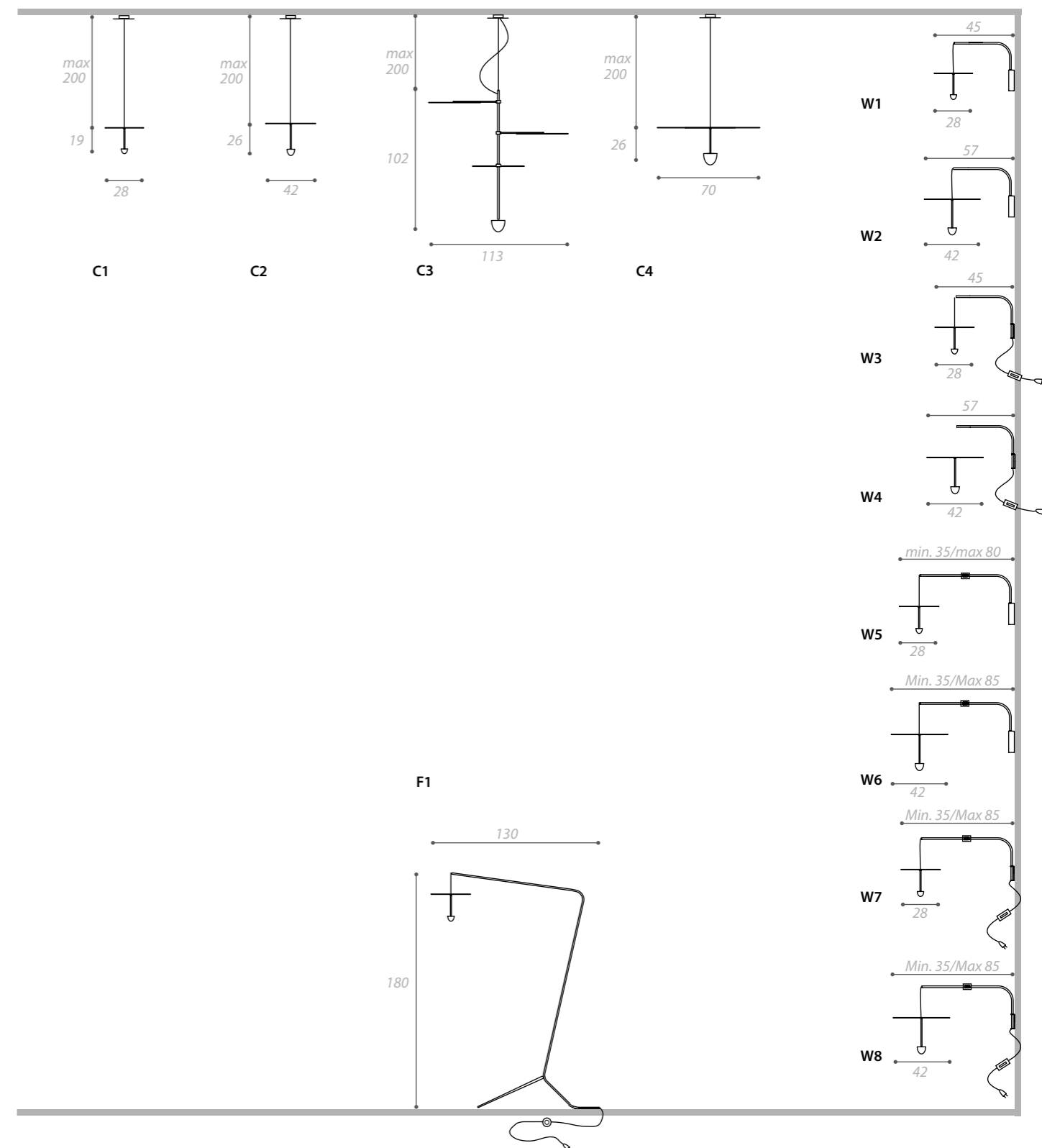

- C1 } LED 13W 110/230v 1000lm 3000°K **A+**
- C2 } LED 13W 110/230v 1000lm 3000°K **A+**
- C3 } LED 17W 110/230v 1350lm 3000°K **A+**
- C4 } LED 13W 110/230v 1000lm 3000°K **A+**
- W1 } LED 13W 110/230v 1000lm 3000°K **A+**
- W2 } LED 13W 110/230v 1000lm 3000°K **A+**
- W3 } LED 13W 110/230v 1000lm 3000°K **A+** Dimmer included
- W4 } LED 13W 110/230v 1000lm 3000°K **A+**
- W5 } LED 13W 110/230v 1000lm 3000°K **A+**
- W6 } LED 13W 110/230v 1000lm 3000°K **A+**
- W7 } LED 13W 110/230v 1000lm 3000°K **A+** Dimmer included
- W8 } LED 13W 110/230v 1000lm 3000°K **A+** Dimmer included
- F1 } LED 13W 110/230v 1000lm 3000°K **A+** Dimmer included

MATERIALE: ottone/
MATERIAL: brass



CE solo per /only for F1

LETTURA

design Gianfranco Marabese 2015/2017



Collezione che affronta il tema della 'lettura' in modo inedito e funzionale: la sottile ma robusta struttura in metallo, accessibile a 360°, realizza originali librerie luminose.

Collection that addresses the theme of "reading" in a new and functional way: the thin but sturdy metal structure, accessible at 360°, creates original luminous bookcases.





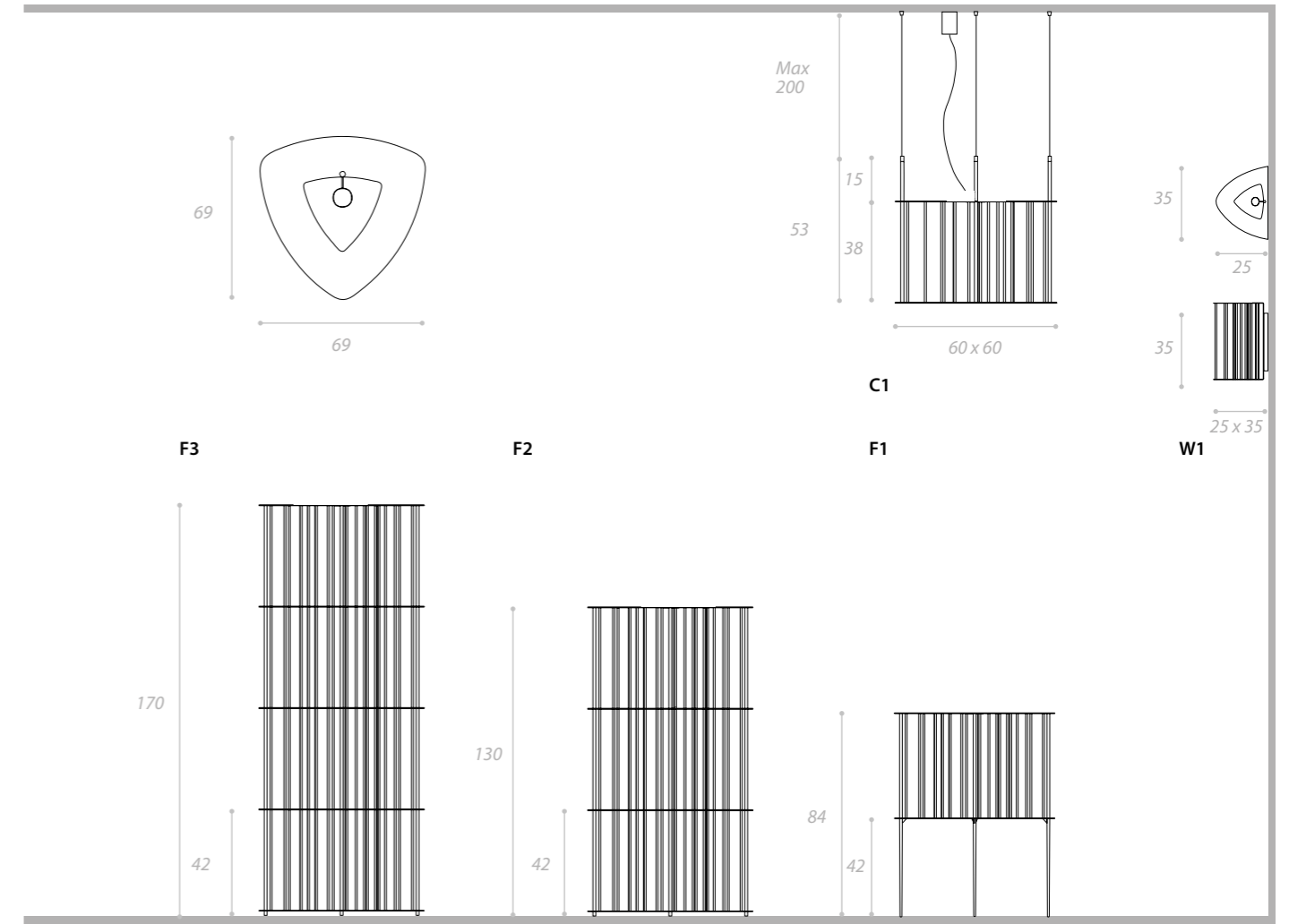

MATERIALE: metallo, piani in bronzo/
 MATERIAL: metal with bronze floors

- W1 LED 110/230V 4,5W 450lm 3000°K
- C1 LED 110/230V 17W 1350lm 3000°K
- F1 } LED 110/230V 17W 1350lm 3000°K Dimmer included
- F2 }
- F3 }



AURORA

design Gianfranco Marabese 2019

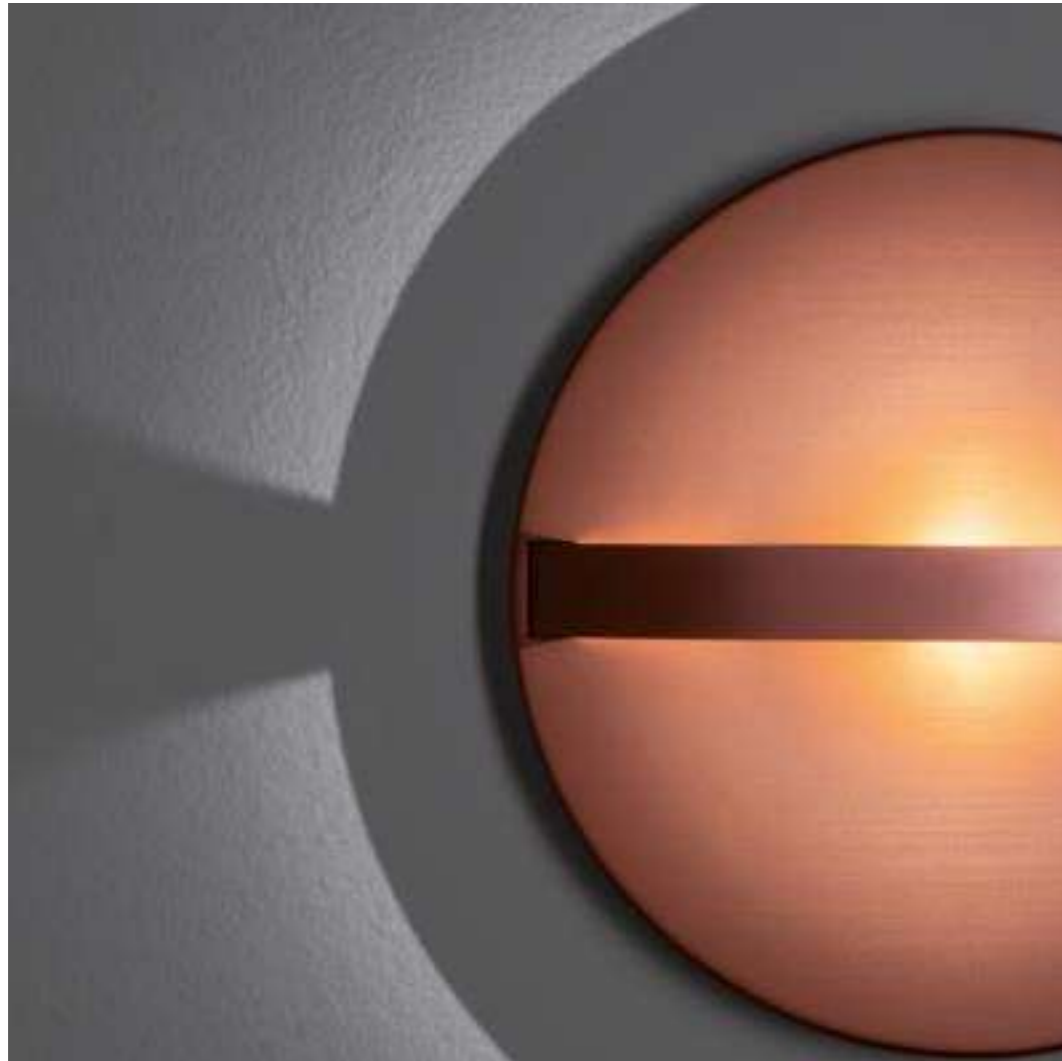

Lampada da parete e soffitto con cuore centrale luminescente. La fonte luminosa espande la luce in modo naturale: diffondendo effetti cromatici affascinanti, che mutano a seconda della superficie riflettente, donando tonalità calde, confortevoli.

Wall and ceiling lamp with central luminescent core. The light source expands the light in a natural way: spreading fascinating chromatic effects, which change depending on the reflecting surface, giving warm, comfortable tones.



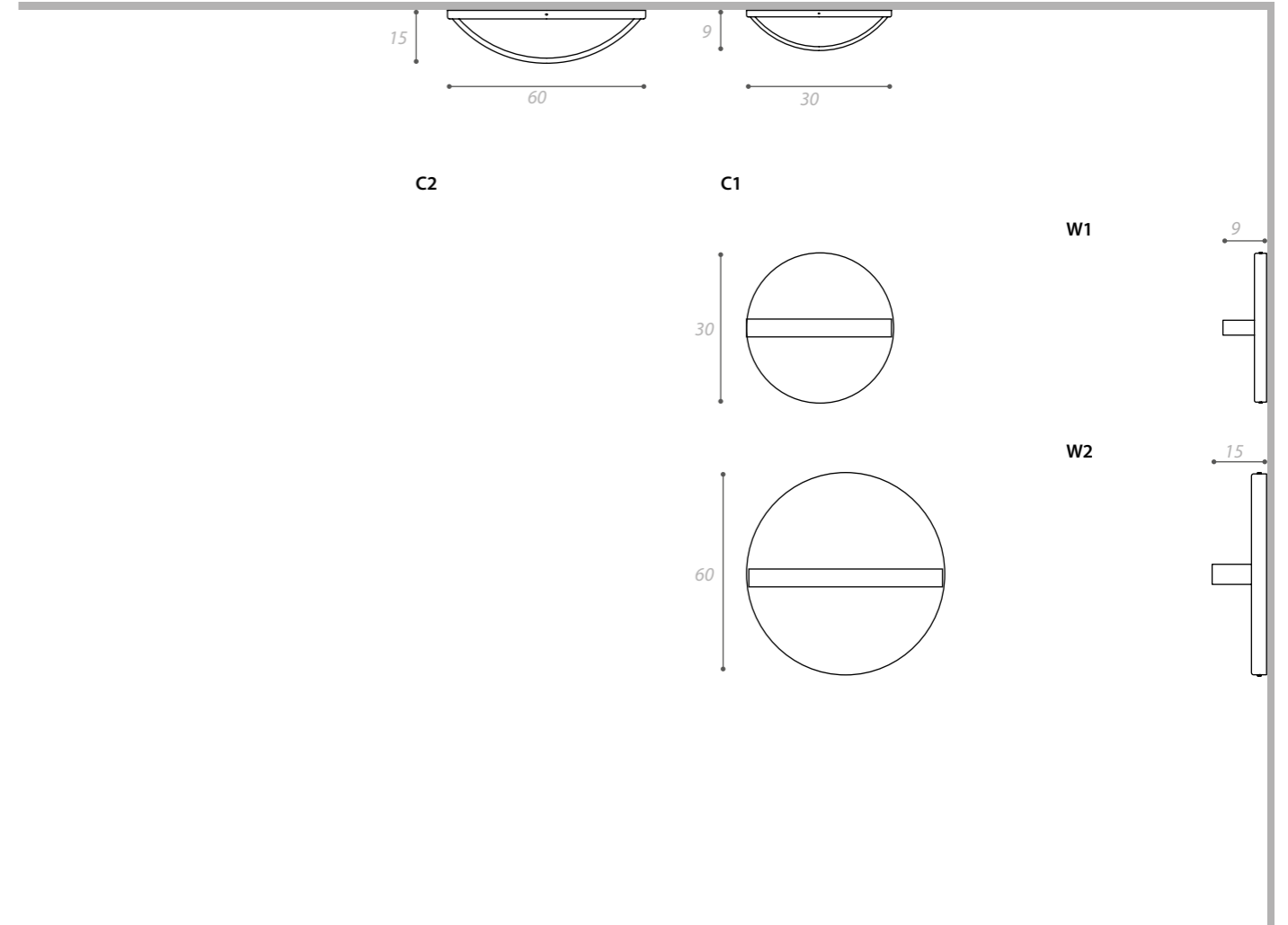

- C1 LED integrato 6W 350mA 800lm 3000K
- C2 LED integrato 12W 350mA 1600lm 3000K
- W1 LED integrato 6W 350mA 800lm 3000K
- W2 LED integrato 12W 350mA 1600lm 3000K

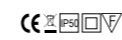

MATERIALI: metallo
MATERIAL: metal

- OTTONE/BRASS
- RAME/COPPER
- BRONZE/ BRONZE
- BIANCO/ WHITE

ARMONICA

design Gianfranco Marabese 2010



Proiettore snodabile per orientare la luce, di forma iconica, dai tratti essenziali, eleganti e un design senza tempo.

Jointed projector to orient the light, iconic in shape, with essential, elegant lines and a timeless design.

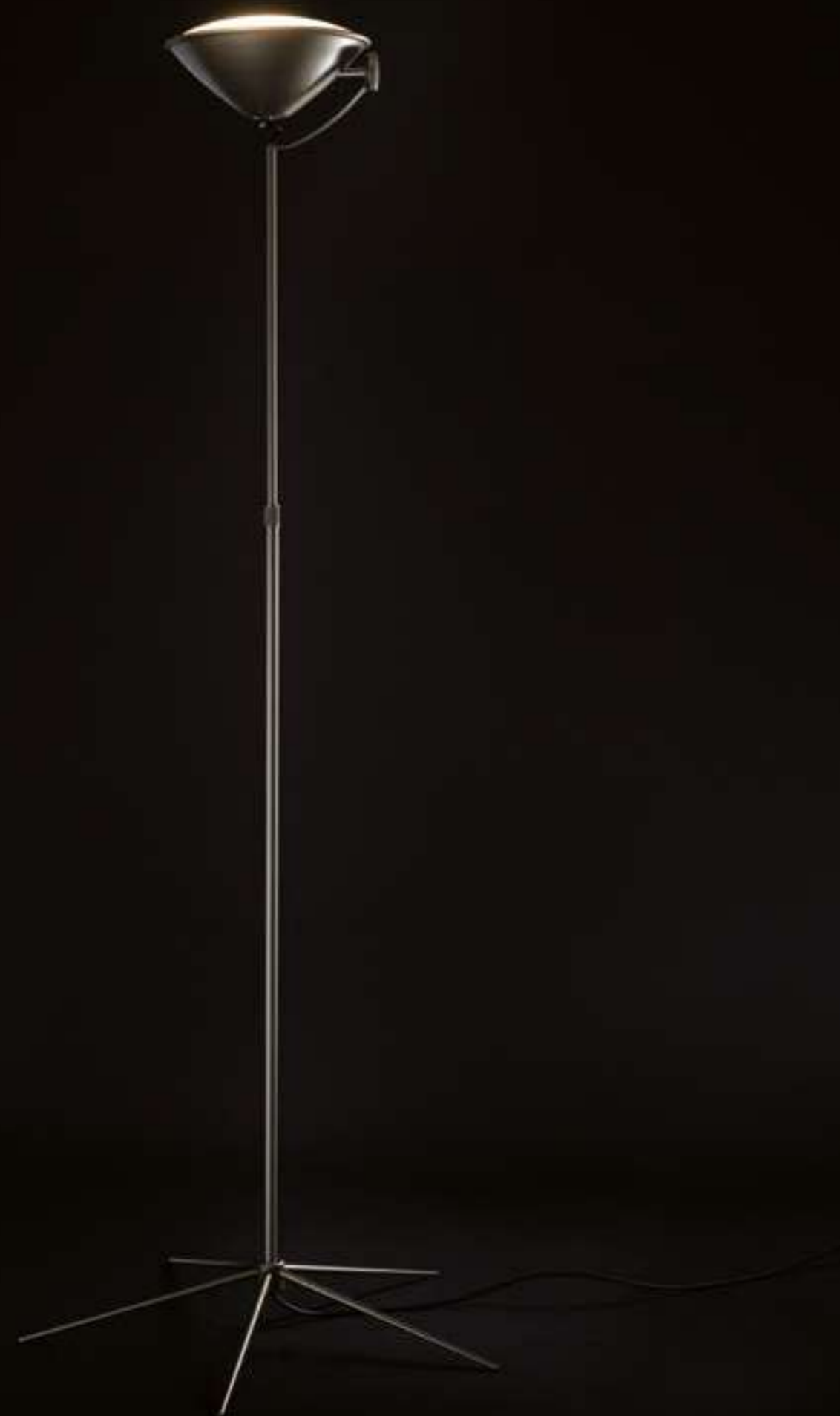



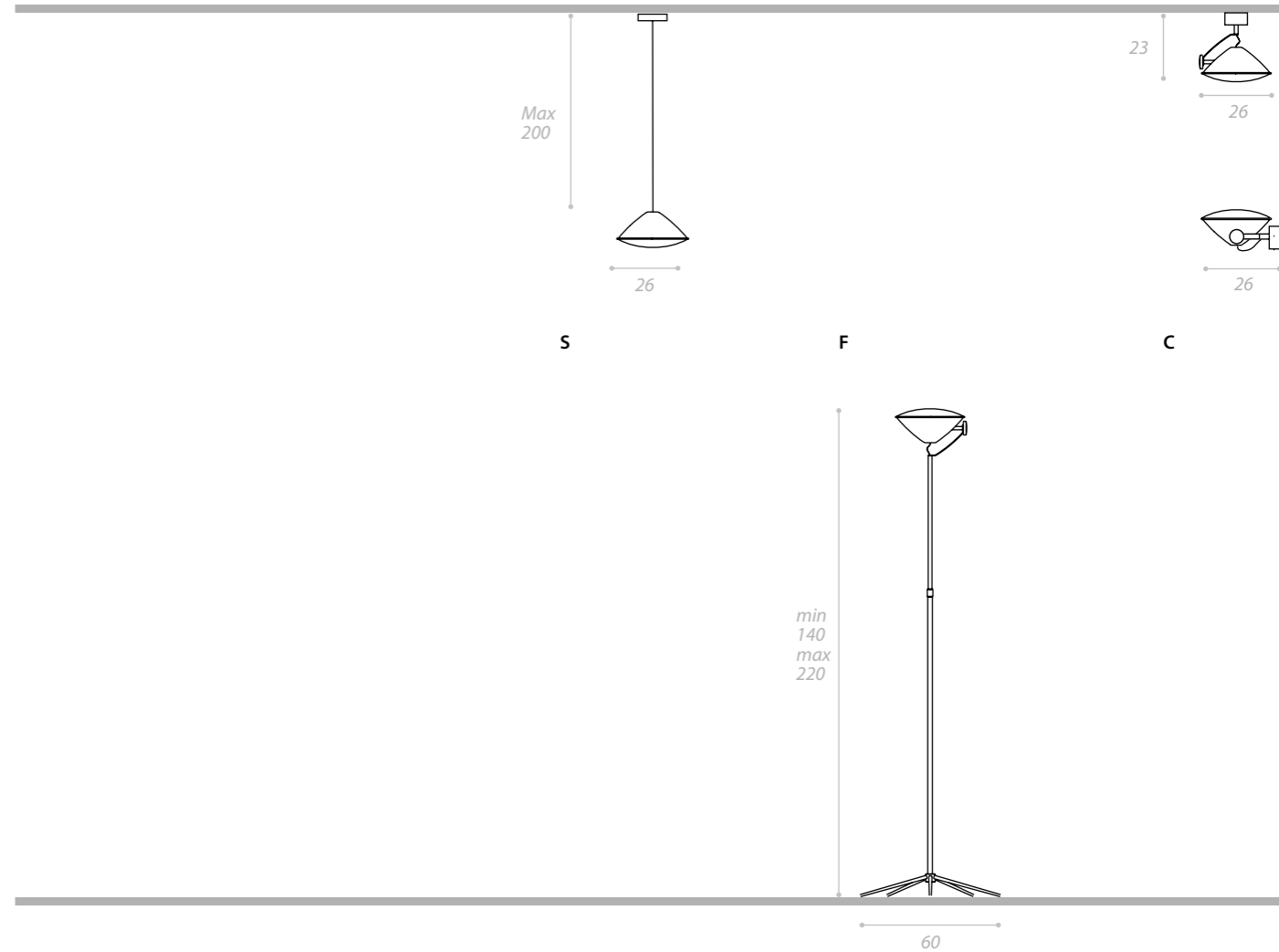

S } LED R7s 118mm 18W 110/230V 2000lm
C } LED R7s 118mm 18W 110/230V 2000lm Dimmer included

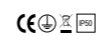

MATERIALI: Metallo
 MATERIAL: metal

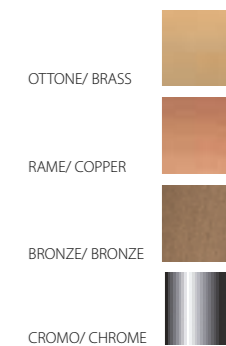

ROBINHOOD

design Gianfranco Marabese 2019



Lampada essenziale e leggera: una struttura in metallo sostiene l'elemento luminoso, che diffonde una luce morbida ma piena, a 360°. Il basamento ospita al suo interno un ricevitore di impulsi radio e con un telecomando è possibile dosare la luce a piacere.

Essential and light lamp: a metal structure supports the luminous element, which diffuses a soft but full light, wat 360°. The base houses inside a radio pulse receiver and with remote control it is possible to dose the light at will.







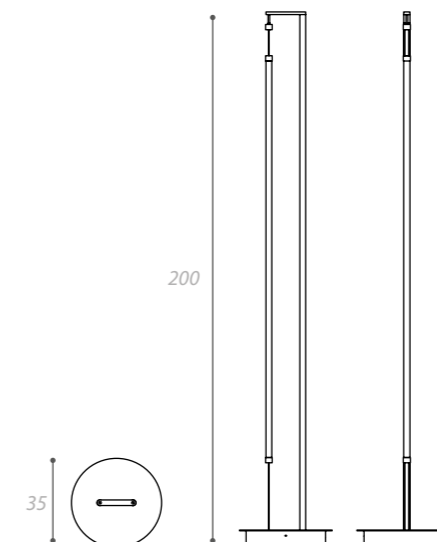

F1



MATERIALI: Metallo e silicone
 MATERIAL: metal and silicon

- BRONZE/ BRONZE 
- OTTONE/BRASS 
- RAME/COPPER 
- BIANCO/WHITE 

F1 LED 24V 60W 3300lm 2700°K / 3000°K / 4000°K Dimmer incluso/Dimmer included



CINEMÀ

design Gianfranco Marabese 2014



Collezione che si ispira alle lampade utilizzate nei set cinematografici. Proiettori LED illuminano l'interno dei diffusori orientabili, che restituiscono luce riflessa senza abbagliare.

Collection inspired by the lamps used in movie sets. LED headlamps illuminate the inside of the adjustable diffusers that return reflected light without dazzling.





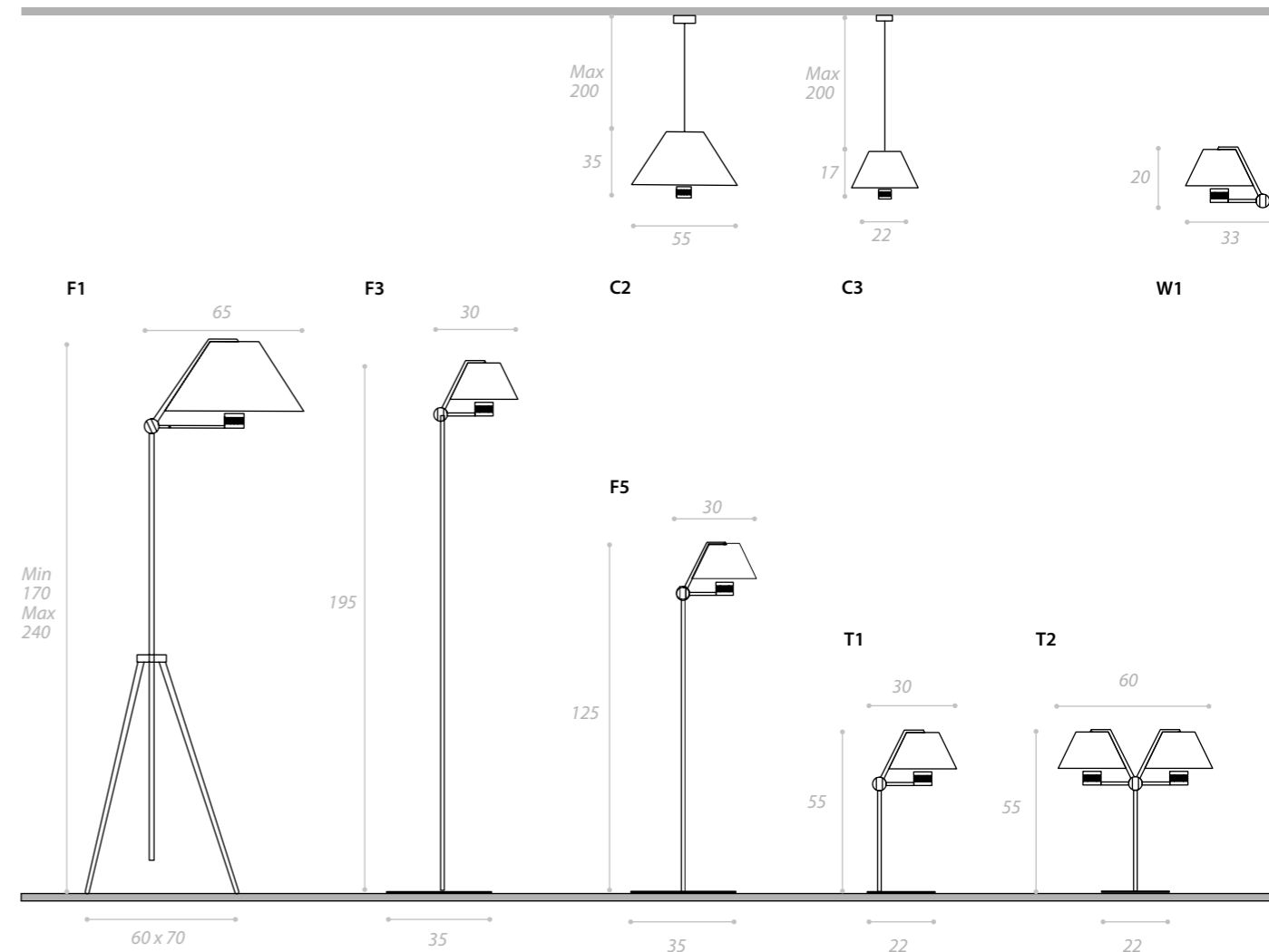

- F1** LED 17W 110/230V 1300lm 3000°k **A+** Dimmer included
- C2** LED 17W 110/230V 1300lm 3000°k
- C3** LED 13W 110/230V 1000lm 3000°k **A+**
- W1** LED 13W 110/230V 1000lm 3000°k **A+**
- T1** 2LED 13W 110/230V 1000lm 3000°k Dimmer included
- F3** LED 13W 110/230V 1000lm 3000°k **A+** Dimmer included
- F5** LED 13W 110/230V 1000lm 3000°k **A+** Dimmer included



MATERIALI: Metallo
MATERIAL: metal

BIANCO/ WHITE

BRONZO-FOGLIA RAME/
BRONZE COPPER LIEF

ALLUMINIO/ ALUMINIUM

BIANCO-FOGLIA ORO/
WHITE GOLD LIEF

NERO-FOGLIA ORO/
BLACK GOLD LIEF



LE GINE

design Sebastiano Tosi 2017



Serie di sospensioni in metallo, di forma diversa, che possono dialogare ed integrarsi tra loro, componendo liberamente, grappoli di luce personalizzati.

Series of metal suspensions, of different shapes, which can dialogue and integrate each other, composing freely, customized cluster of light.







C1

C2

C3

C4



MATERIALE: metallo/
MATERIAL: metal

OTTONE/ BRASS

BIANCO/ WHITE

NERO/BLACK

BRONZE/BRONZE

C1 }
 C2 } LED GU10 110/230V
 C3 }
 C4 }



PIÙ&MENO

design Sebastiano Tosi 2019



Progetto che nasce dall'idea di creare un oggetto di luce, in continua evoluzione, che comunichi con il fruitore creando un linguaggio inedito e personale, animato e ludico, contemporaneo e interattivo. Segmenti luminosi si applicano sul disco liberamente, attraverso un magnete: variando così la densità luminosa a seconda della loro disposizione.

Project born from the idea of creating an object of light, in continuous evolution, that communicates with the user, creating a new and personal, animated and playful, contemporary and interactive language. Luminous segments are applied to the disk freely, through a magnet: thus varying the luminous density according to their arrangement.





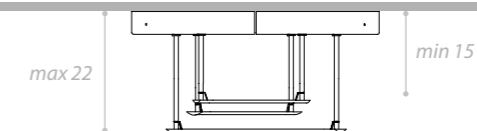
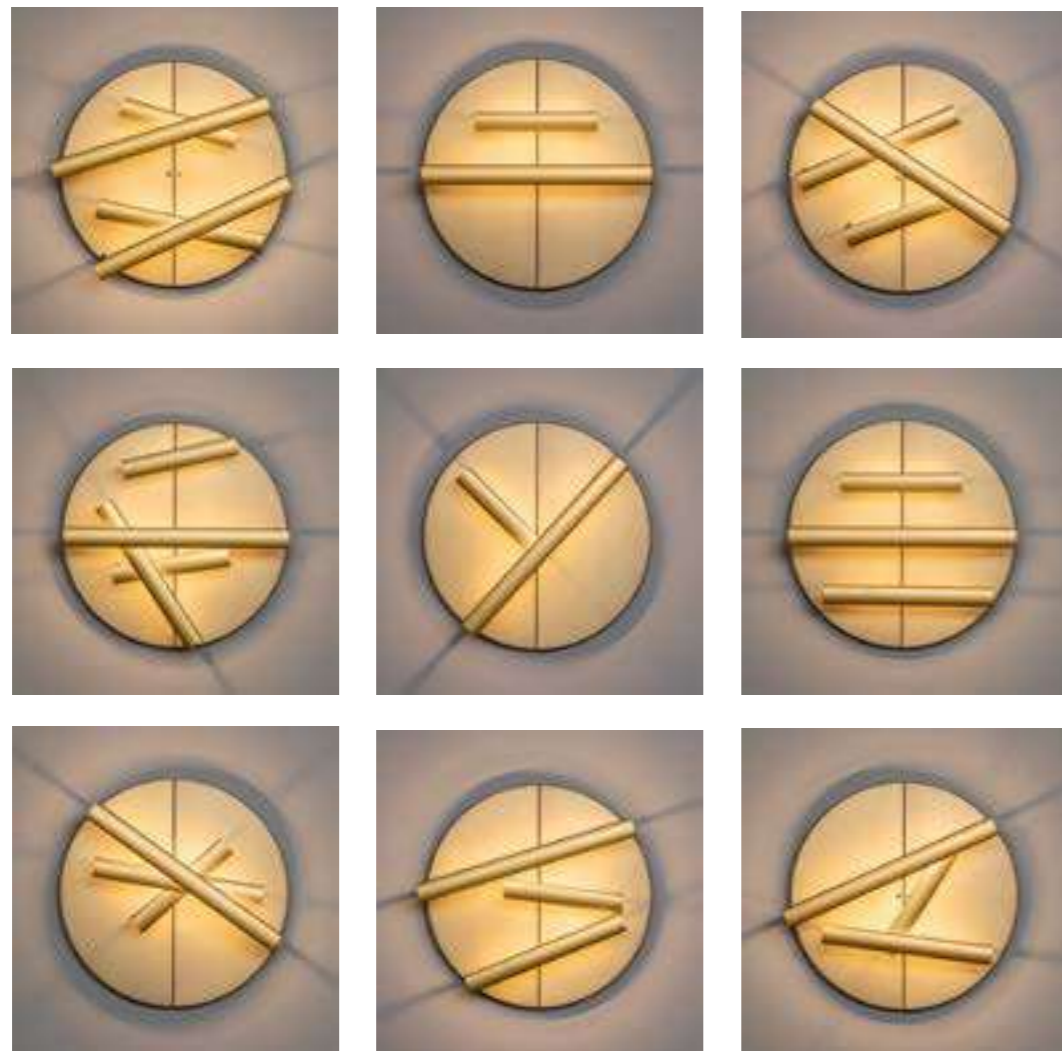

C1

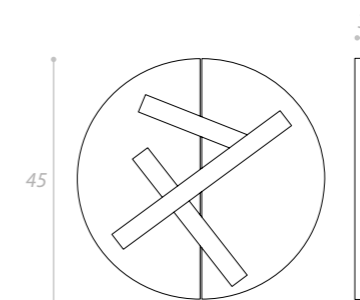

W1

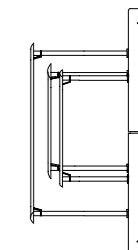

DISCO BASE CON TRASFORMATORE INCORPORATO/
BASIC DISK WITH BUILT-IN DRIVER

COMPOSIZIONI DA 2 A 4 PONTI/
COMPOSITION FROM 2 TO 4 BRIDGES

P1

P2

P3

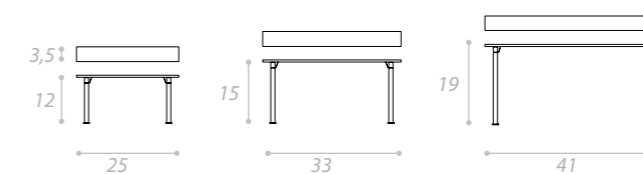

SEGMENTI LUMINOSI A PONTE CON LED E MAGNETI/
BRIDGE SYSTEM LUMINOUS SEGMENTS WITH LEDS AND MAGNETS

- C1
 - P1 3,5W 510lm 24V
 - P2 5,5W 750lm 24V
 - P3 7,5W 1005lm 24V
- W1
 - P1 3,5W 510lm 24V
 - P2 5,5W 750lm 24V
 - P3 7,5W 1005lm 24V



MATERIALE: metallo/
MATERIAL: metal

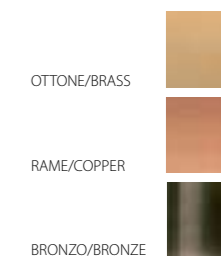

PENELOPE

design Sebastiano Tosi 2017



Un intreccio armonico e preciso di fili metallici, forma una sfera leggera e trasparente, che dà vita ad una collezione di lampade, a luce diretta ed indiretta.

A harmonious and precise weaving of metal wires, forming a light and transparent sphere, that gives life to a collection of lamps, with direct and indirect light.





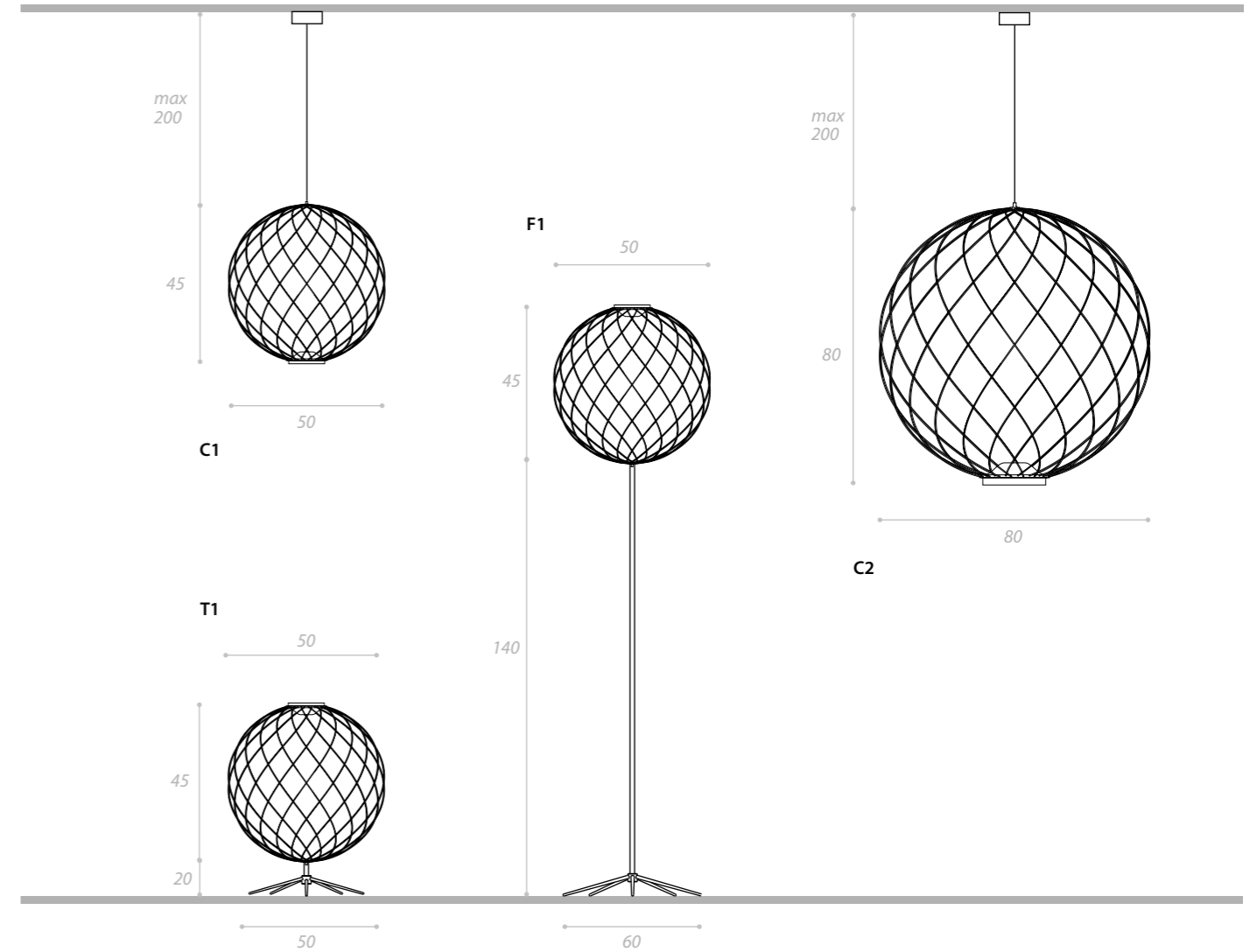

C1/C2 [luce indiretta: LED 4,5W 110/230V 450lm 3000K°
 luce diretta: LED 17W 110/230V 1350lm 3000°K
T1/F1 [luce indiretta: LED 4,5 W110/ 230v 450 lm 3000K° Dimmer included
 luce diretta: LED 17W 110/230V 1350 lm 3000°K Dimmer included

CE, V, I, PS, C1/C2, T1/F1

MATERIALE: metallo/
 MATERIAL: metal

OTTONE/BRASS

WHITE/BIANCO

NERO/BLACK

BRONZO/ BRONZE

PENOMBRA

design Sebastiano Tosi 2014

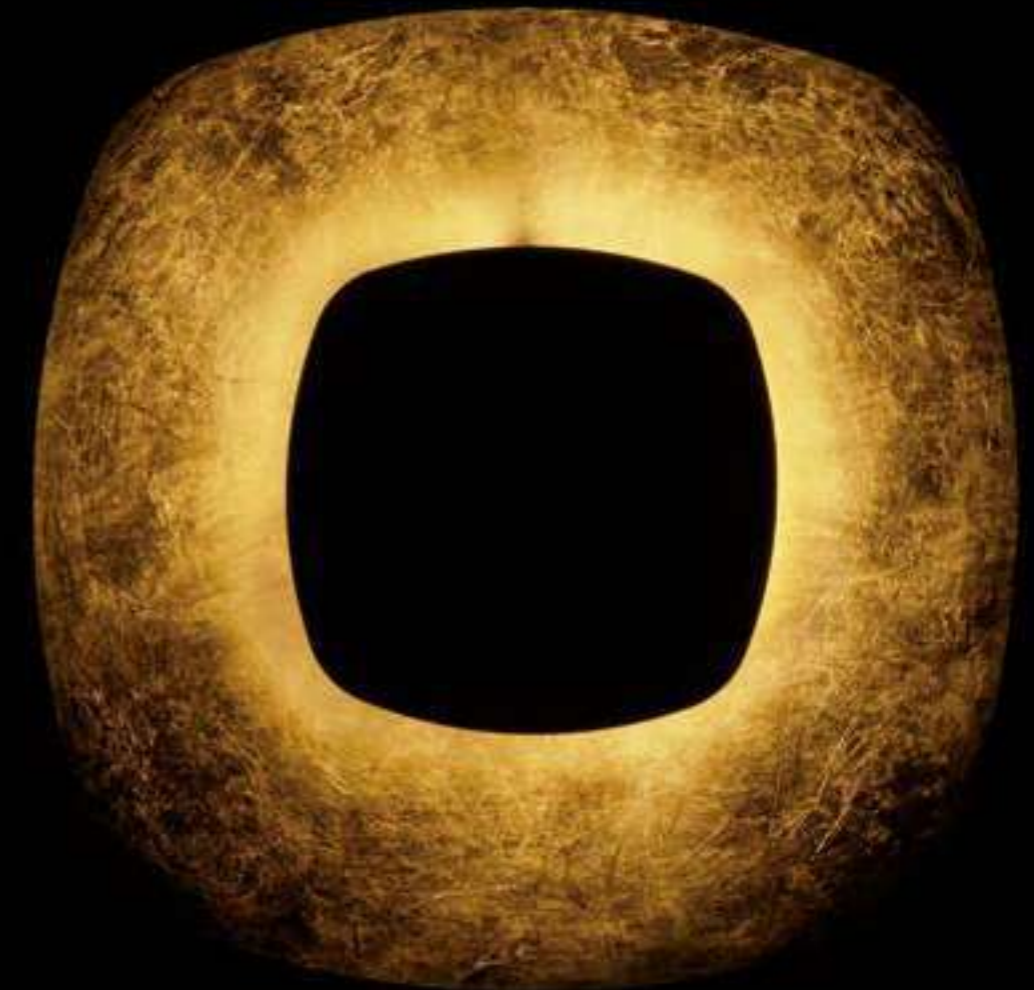
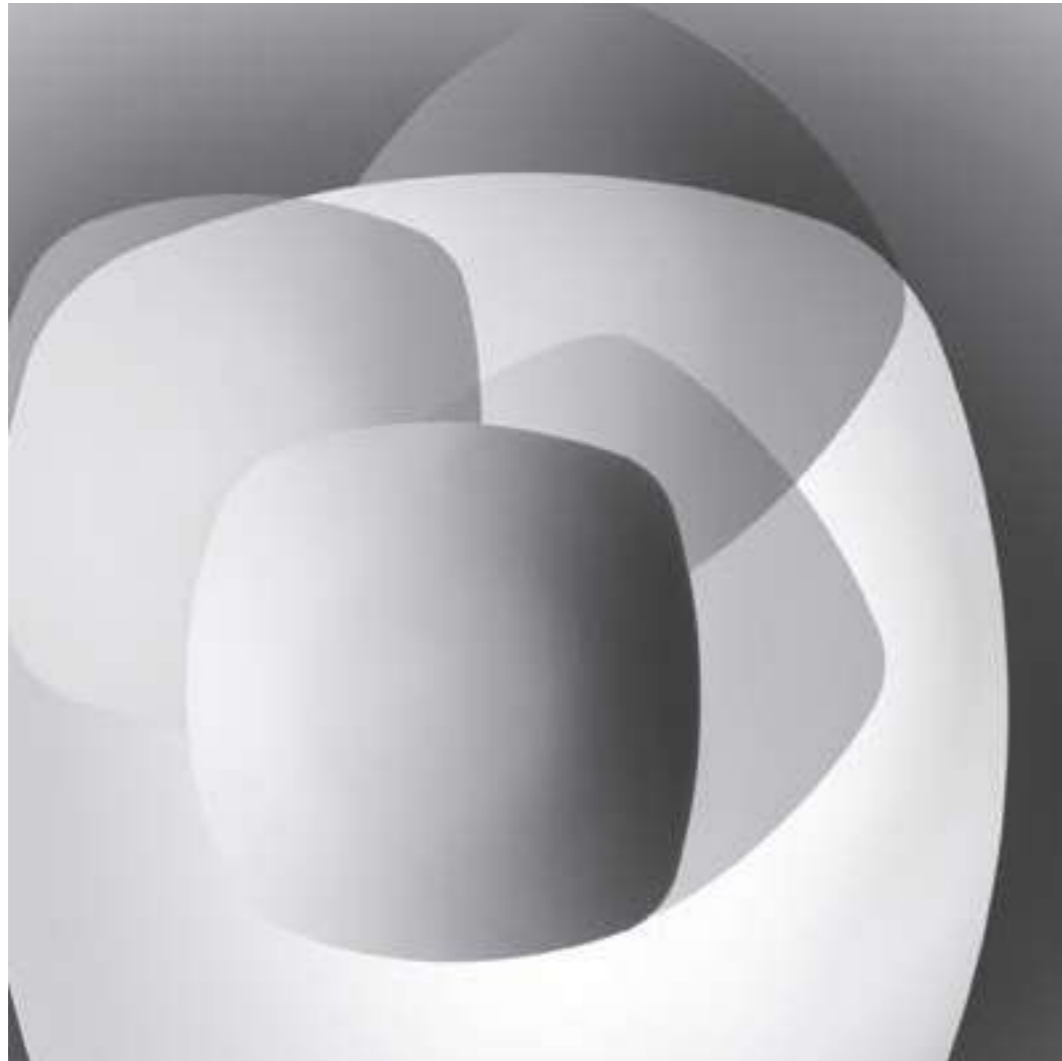

Collezione di lampade con parabole riflettente a fuoco variabile. La luce del LED mette in evidenza preziose lavorazione ed eleganti finiture opache.

Collection of lamps with variable focus reflective parables. The LED light highlights precious workmanship and elegant matt finishes.





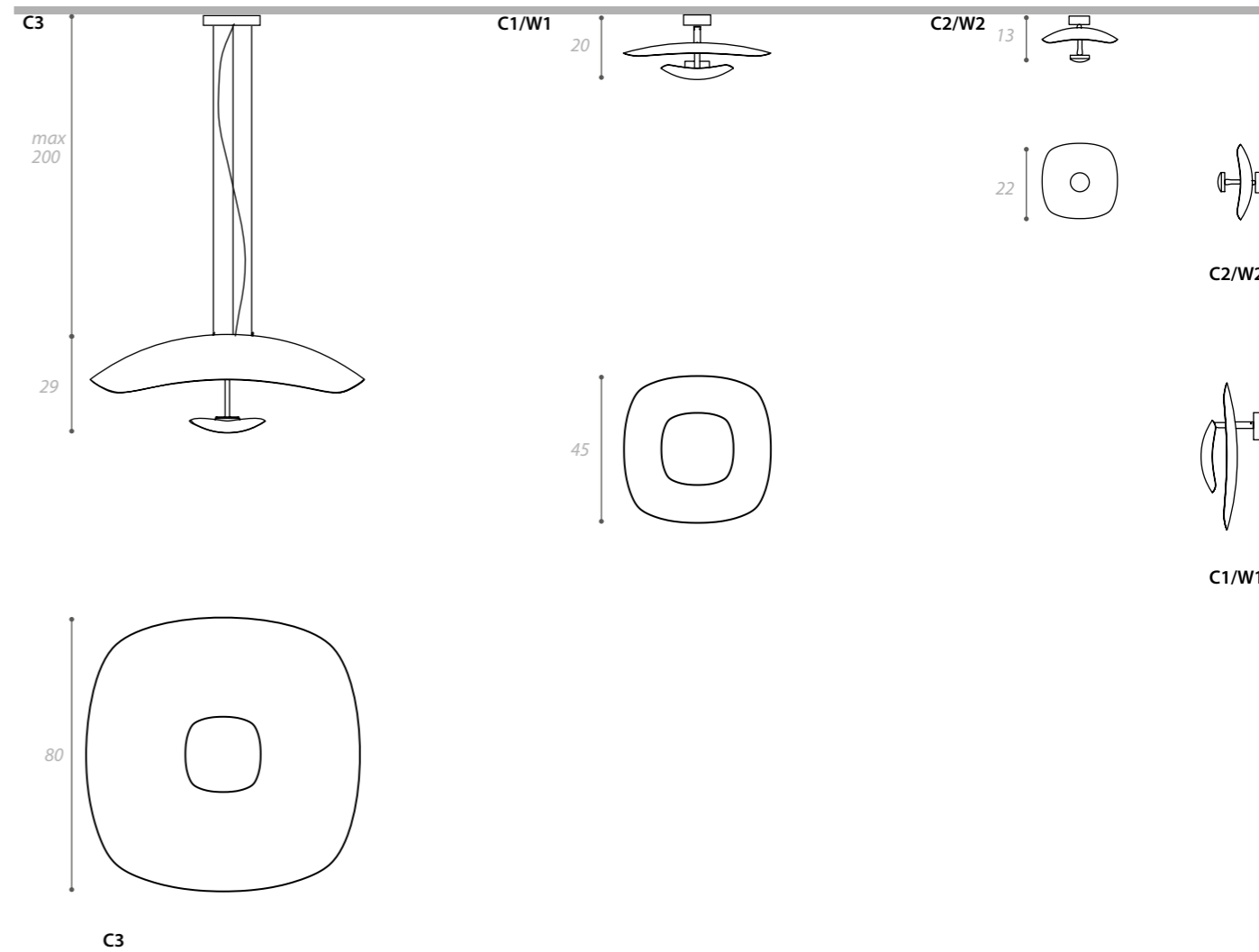

MATERIALE: metallo/
MATERIAL: metal

NERO-FOGLIA ORO
BLACK-GOLD LIEF

BIANCO-FOGLIA ORO/
WHITE-GOLD LIEF

BRONZO-FOGLIA RAME/
BRONZE-COPPER LIEF

BIANCO/WHITE



C3 LED 17W 110/230V 1300lm 3000°k **A+**
W1/C1 LED 4,5W 110/230V 330lm 3000°k **A+**
W2/C2 LED 4,5W 110/230V 330lm 3000°k **A+**



OPERA

design Bruno e Lorenzo Gecchelin 2019







Lampada da parete dal disegno semplice ma elegante. La forma circolare, dolcemente curvata, avvolge la fonte luminosa permettendole di espandersi nello spazio: una geometria esaltata da preziose finiture metalliche.

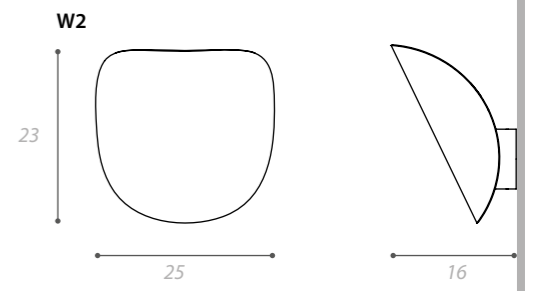
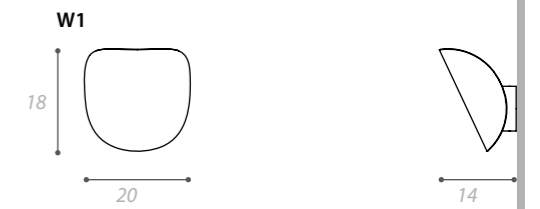

Wall lamp with a simple but elegant design. The circular shape, gently curved, wraps the light source allowing it to expand in space: a geometry enhanced by precious metallic finishes.





MATERIALE: metallo/
MATERIAL: metal

- OTTONE/BRASS 
- RAME/COPPER 
- BRONZO/BRONZE 
- BIANCO/WHITE 

W1 Gu10 750lm 
W2 E27 Led 2550lm 



VOLO

design Lorenzo Gecchelin 2009



Un profilo essenziale e un disegno elegante: un foglio di metallo, che si appoggia alla parete.

An essential profile and an elegant design: a sheet of metal, leaning on the wall.





W1

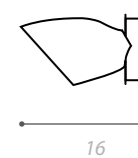
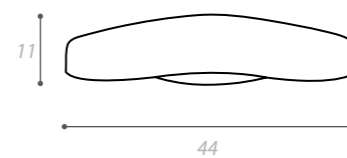

MATERIALE: metallo
MATERIAL: metal

- RAME SATINATO/
SATINED COPPER
- BRONZO/ BRONZE
- BIANCO/ WHITE
- OTTONE/ BRASS

W1 LED E27 20W 2500lm



VIVAEDISON

design Gianfranco Marabese 2015



La lampadina di memoria si trasforma in un grande diffusore di luce in vetro borosilicato. Le importanti dimensioni sono state spinte fino al limite della fattibilità tecnica: per un risultato formale sorprendente e una luce confortevole.

The memory light bulb turns into a large borosilicate glass light diffuser. The important dimensions have been pushed to the limit of technical feasibility: for a surprising formal result and a comfortable light.





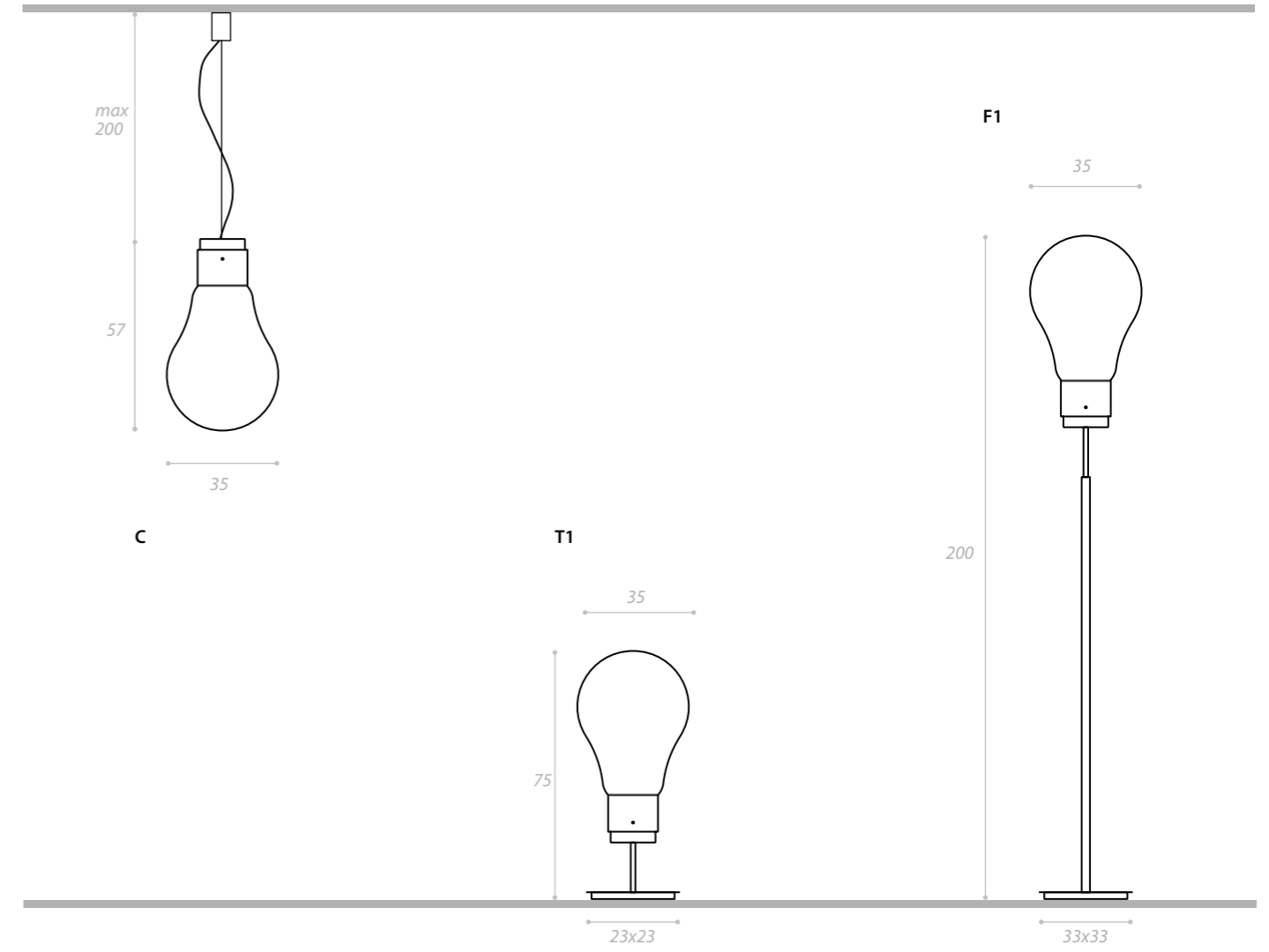

C LED 17W 110/230 1300lm 3000°k **A+**
F1 } LED 17W 110/230 1300lm 3000°k **A+** Dimmer included
T1 }



MATERIALE: vetro borosilicato/
MATERIAL: borosilicate glass

BRONZO/ BRONZE



OTTONE/ BRASS



TORCETTA

design R&S Antonangeli 2010



Piccola sospensione a LED utilizzabile singolarmente o in aggregato, per installazioni luminose personalizzate.

Small LED suspension that can be used individually or in aggregate, for a customized light installation.



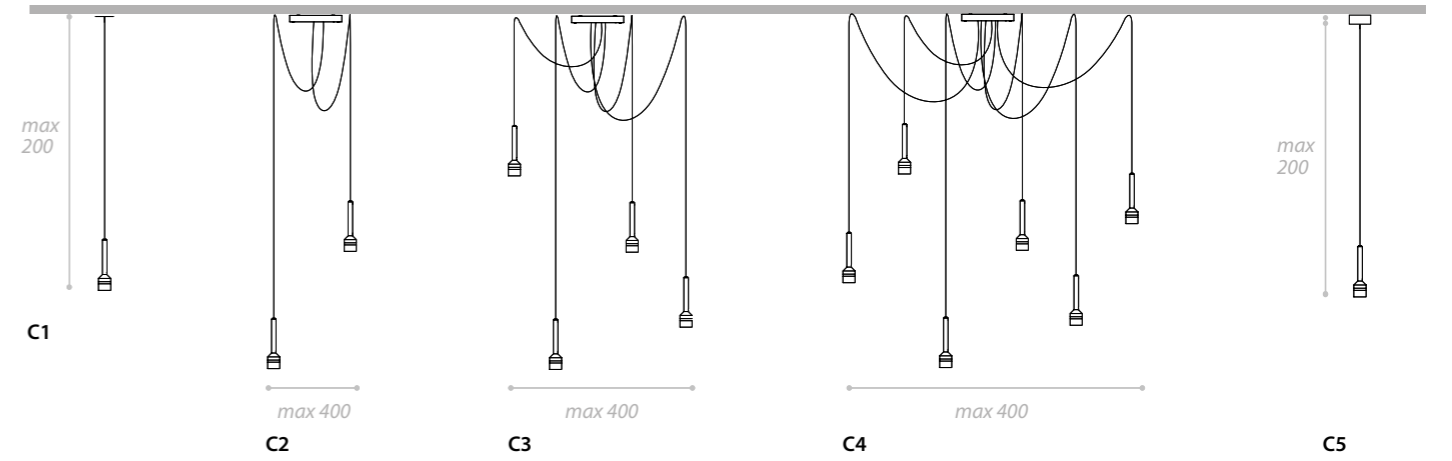

Attacco rapido/rapid connection

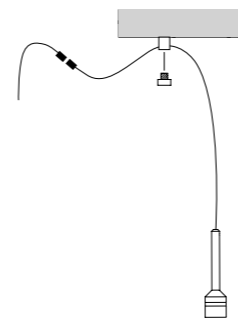

Esempi d'installazione/mounting examples

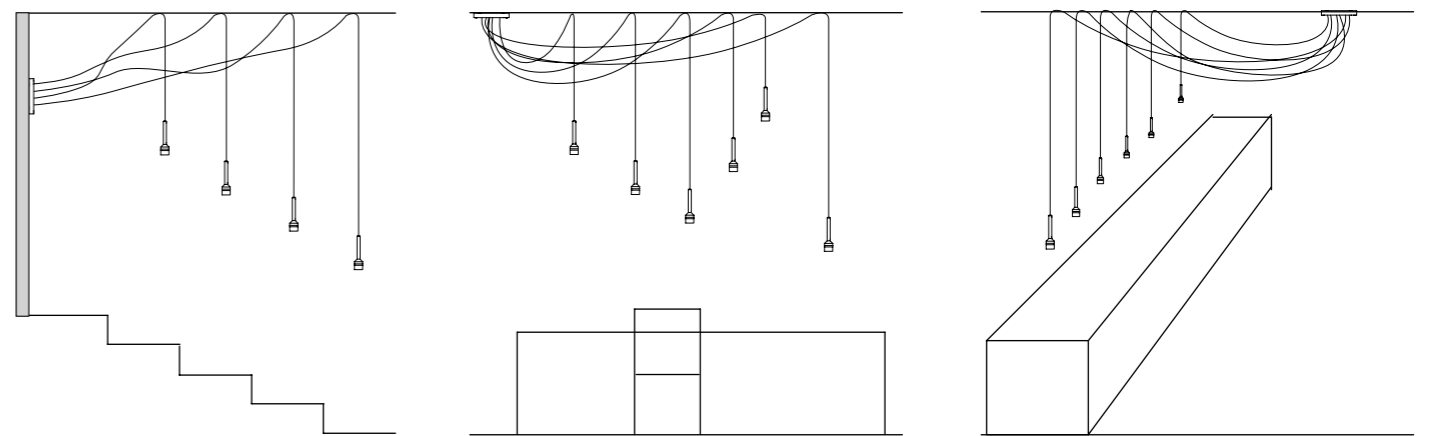

MATERIALI: metallo
MATERIAL: metal

- C1 1x LED 3W 700mA (160lm) **A+** singola, alimentatore remoto non incluso/single, remote converter not included
- C2 4x LED 3W 700mA (640lm) **A+** 4 lampade alimentatore incorporato/4 lamps inside converter
- C3 6x LED 3W 700mA (960lm) **A+** 6 lampade alimentatore incorporato/6 lamps inside converter
- C4 8x LED 3W 700mA (1280lm) **A+** 8 lampade alimentatore incorporato/8 lamps inside converter
- C5 1x LED 3W 700mA (160lm) **A+** singola con alimentatore incluso/single with converter included

CE a richiesta/on demand

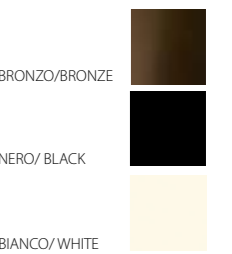

CONTATTO

design Gianfranco Marabese 2015



Spot che genera coni di luce variabili, attraverso un movimento a cannocchiale. L'aggancio tramite magnete, sulle diverse tipologie di struttura, permette libere movimentazioni e orientabilità degli effetti luminosi.

Spot that generates variable cones of light through a telescope movement. Coupling with magnets, on the different type of structures, allows free movement and adjustments of the light's effects.









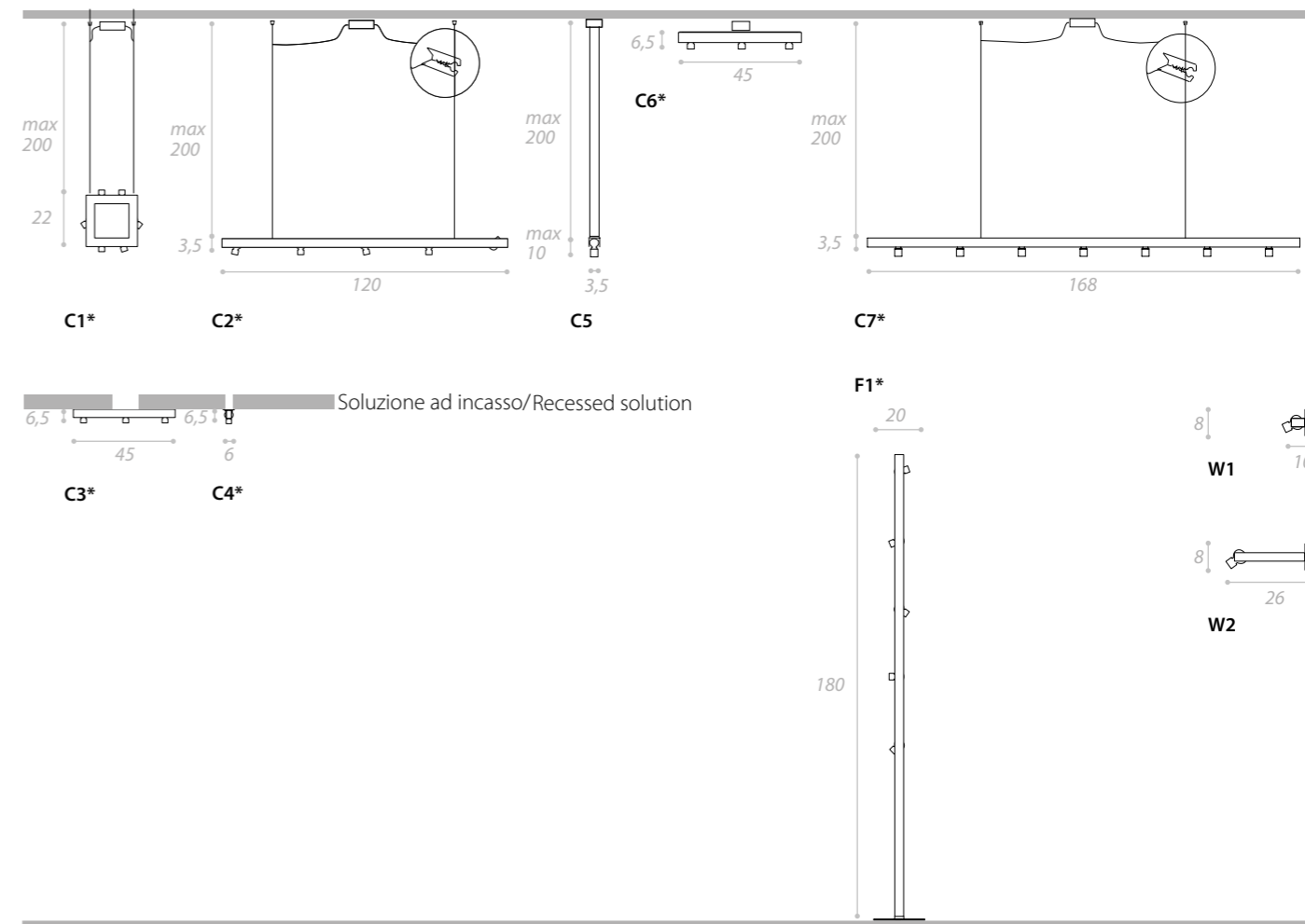

Spot

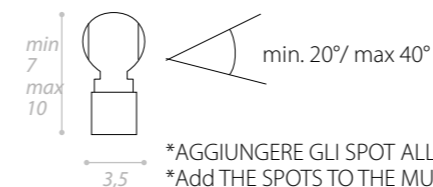

*AGGIUNGERE GLI SPOT ALLE STRUTTURE MULTIPLE: C1, C2, C3, C6, C7, F1
 *Add THE SPOTS TO THE MULTIPLE STRUCTURE: C1, C2, C3, C6, C7, F1

SOLUZIONI AD INCASSO/RECESSED SOLUTIONS

C3*

Hole 2,9cm x 15cm
 tenere il lato lungo del foro
 nella direzione della lampada/
 keep the longest side of the
 hole to the same lamp's
 direction.

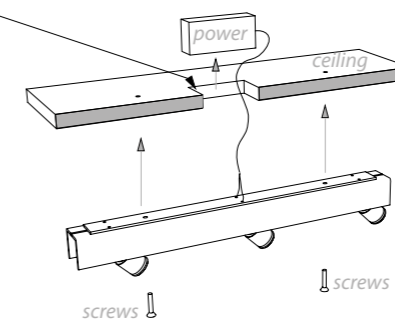

C4*

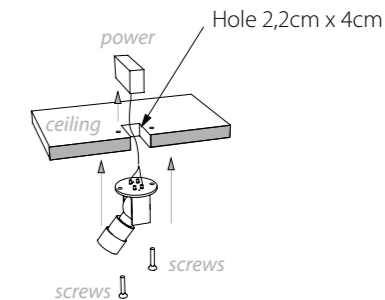

Spot LED 4,5W 650lm 3000°K **A+**

- C1** solo struttura per 6 spot, trasformatore incluso/only structure for 6 spot, driver included
- C2** solo struttura per max 5 spot, trasformatore incluso/only structure for max 5 spot, driver included
- C3** solo struttura ad incasso per max 3 spot, trasformatore non incluso/only recessed structure max 3 spot, no driver
- C4** incasso singolo, spot incluso, alimentatore non incluso/ single recessed lamp, one spot included, no driver
- C5** sospensione singola, alimentatore incluso/suspended single lamp's spot, driver included
- C6** solo struttura per max 3 spot, trasformatore incluso/only structure for max 3 spot, driver included
- C7** solo struttura per 7 spot, trasformatore incluso/only structure for 7 spot, driver included
- F1** solo struttura per max 5 spot, trasformatore incluso/only structure for max 5 spot, driver included
- W1** parete corta, alimentatore e spot inclusi/short wall lamp, spots and driver included
- W2** parete lunga, alimentatore e spot inclusi/long wall lamp, spots and driver included

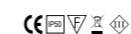

MATERIALI: metallo
 MATERIAL: metal

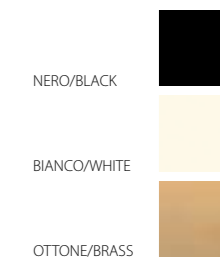

BELL COLLECTION

design Sergio Brioschi 1996/2003



Forme arrotondate, per diffusori con anima tecnica e cuore decorativo. Quattro le dimensioni per diverse tipologie, tutte compatibili tra loro, grazie alla loro stessa radice formale, dall'alta e differenziata possibilità di utilizzo.

Rounded shapes, for diffusers with technical soul and decorative heart. Four sizes for different types, all compatible with each other, thanks to their same formal root, high and differentiated possibility of use.









108 Bell Collection/ Host 2013/Cierresse arred s.r.l./Cabiato/Italy



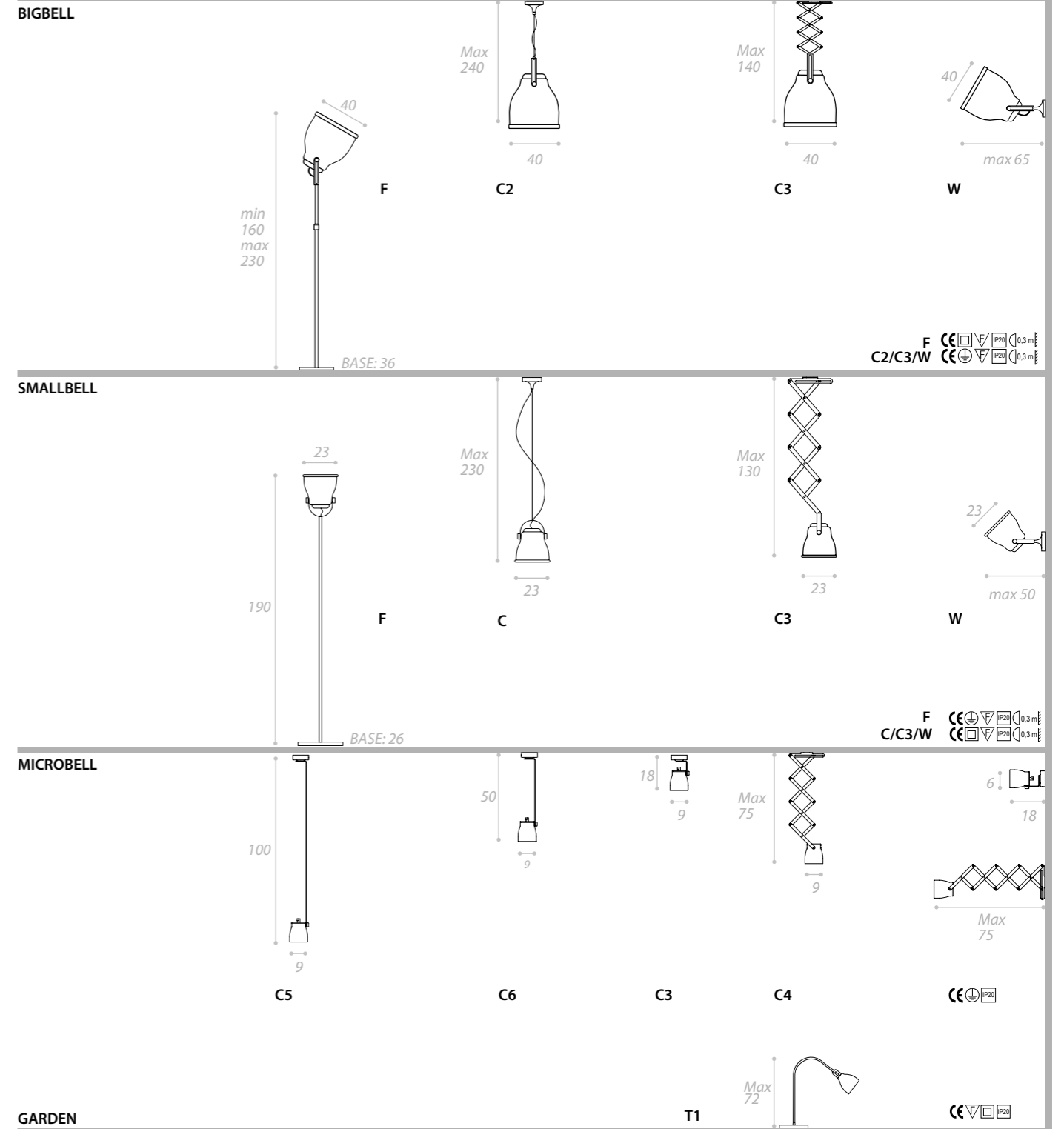

BIGBELL

- F LED E27 20W 2500lm Dimmer included
- C2 LED E27 20W 2500lm
- C3 LED E27 20W 2500lm
- W

SMALLBELL

- F LED E27 20W 2500lm Dimmer included
- C LED E27 20W 2500lm
- C3 LED E27 20W 2500lm
- W

MICROBELL

- C3 LED GU10 110/220V
- C4 LED GU10 110/220V
- C5 LED GU10 110/220V
- C6 LED GU10 110/220V

GARDEN

- T1 LED E27 12W 1500lm

MATERIALE: alluminio/
MATERIAL: aluminium
RAME/ COPPER

ALLUMINIO/ ALUMINIUM

OTTONE/ BRASS

BRONZO/ BRONZE

BIANCO/ WHITE

NERO/ BLACK



VIOLINO

design Gabi Peretto 2017



Sospensione generata da un tubo metallico che si avvolge su sé stesso ed è supporto e struttura per una lampadina a vista o un cilindro con cui ottenere coni di luce variabili.

Suspension generated by a metal tube that wraps around itself and it is support and structure for a visible light bulb or a cylinder with which to obtain variable light cones.



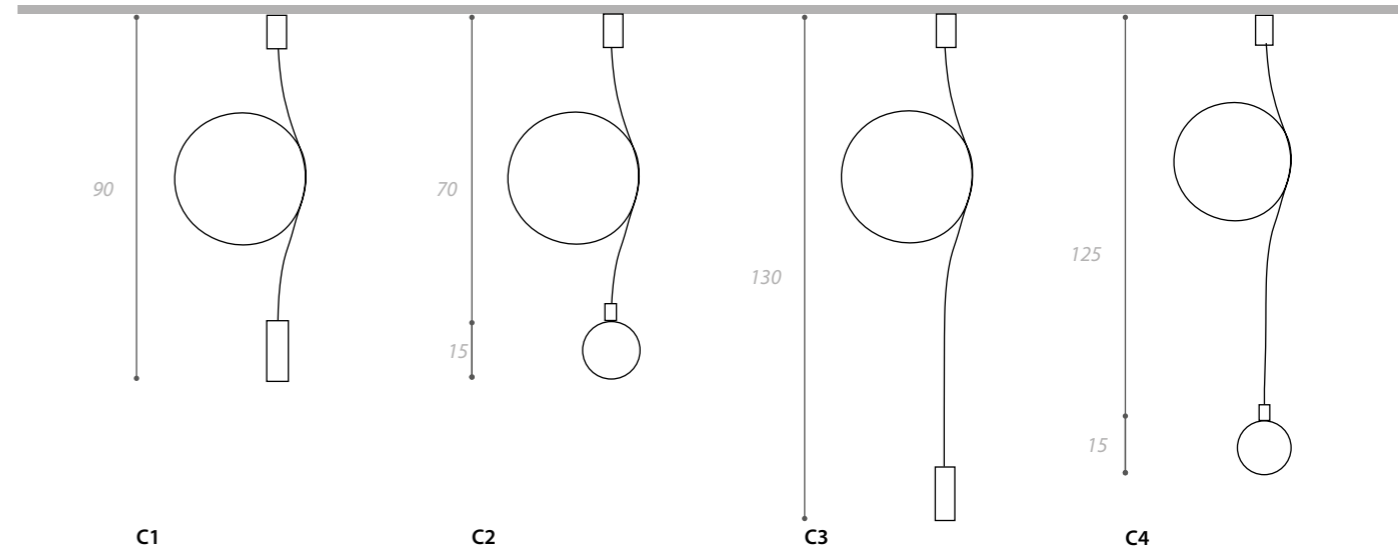

- C1] LED GU10 110/230V
- C3] LED GU10 110/230V
- C2] Globolux E27 110/230V
- C4] Globolux E27 110/230V



MATERIALE: metallo/
MATERIAL: metal

- OTTONE/ BRASS 
- NERO/ BLACK 
- BIANCO/ WHITE 

FORMOSA

design Aldo Cibic 2005

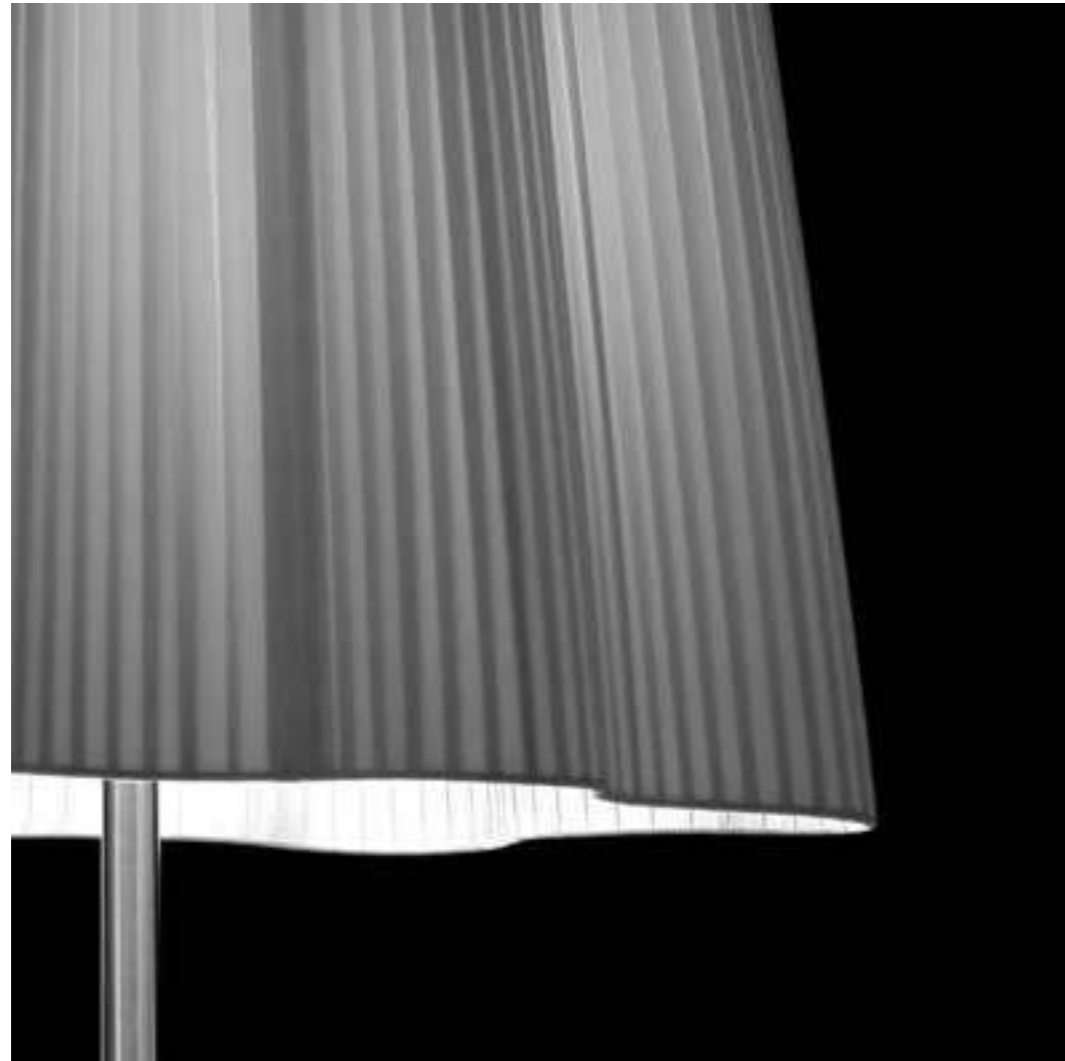

Collezione di lampade con diffusore in tessuto di forma asimmetrica, utilizzabile singolarmente o in aggregato.

Collection of lamps with asymmetrical shaped fabric diffuser, usable individually or in aggregate.







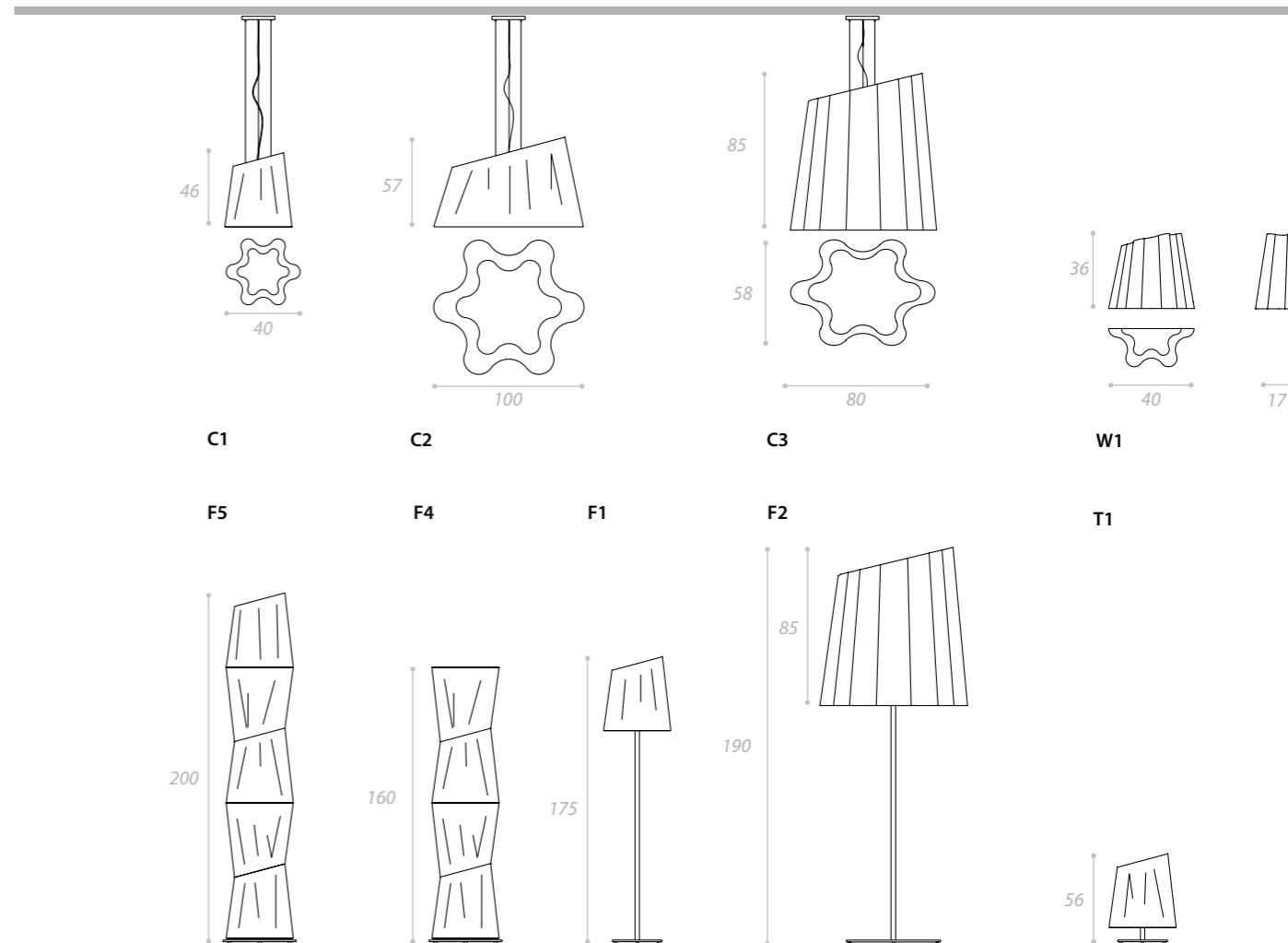

- W1**
 - C1**
 - C2** LED E27 20W 2500lm
 - C3**
 - F5** 10x LED E14 6W 470lm (4700lm)
 - F4** 8x LED E14 6W 470lm (3760lm)
 - T1** 2x LED E14 6W 470lm (940lm)
 - F1** 2x LED E14 6W 470lm (940lm)
 - F2** 3x LED E27 20W 2500lm (7500lm)
- A+** **Dimmer included**
A+ **Dimmer included**
A+ **Dimmer included**
A+ **Dimmer included**
A+ **Dimmer included**
- C1/C2/C3
 F1/F2/F4/F5/T1/W1

MATERIALI: Struttura in Metallo.
Paralume in tessuto

MATERIALS: Metal's Structure.
Textile shader.



RICAMI

design Gianfranco Marabese 2009



Collezione di lampade a paralume, con diffusore in vetroresina bianco caldo, di diverse dimensioni e soluzioni tipologiche: resistente all'urto, lavabile, di facile manutenzione. Un cilindro di vetro borosilicato, all'interno del paralume, avvolge e scherma le fonti luminose per evitare abbagliamenti.

Collection of lampshades with diffuser in warm white fibreglass, of different sizes and typological solutions: impact resistant, washable, easy to maintain. A cylinder of borosilicate glass, inside the lampshade, wraps and screens light sources to avoid dazzling.



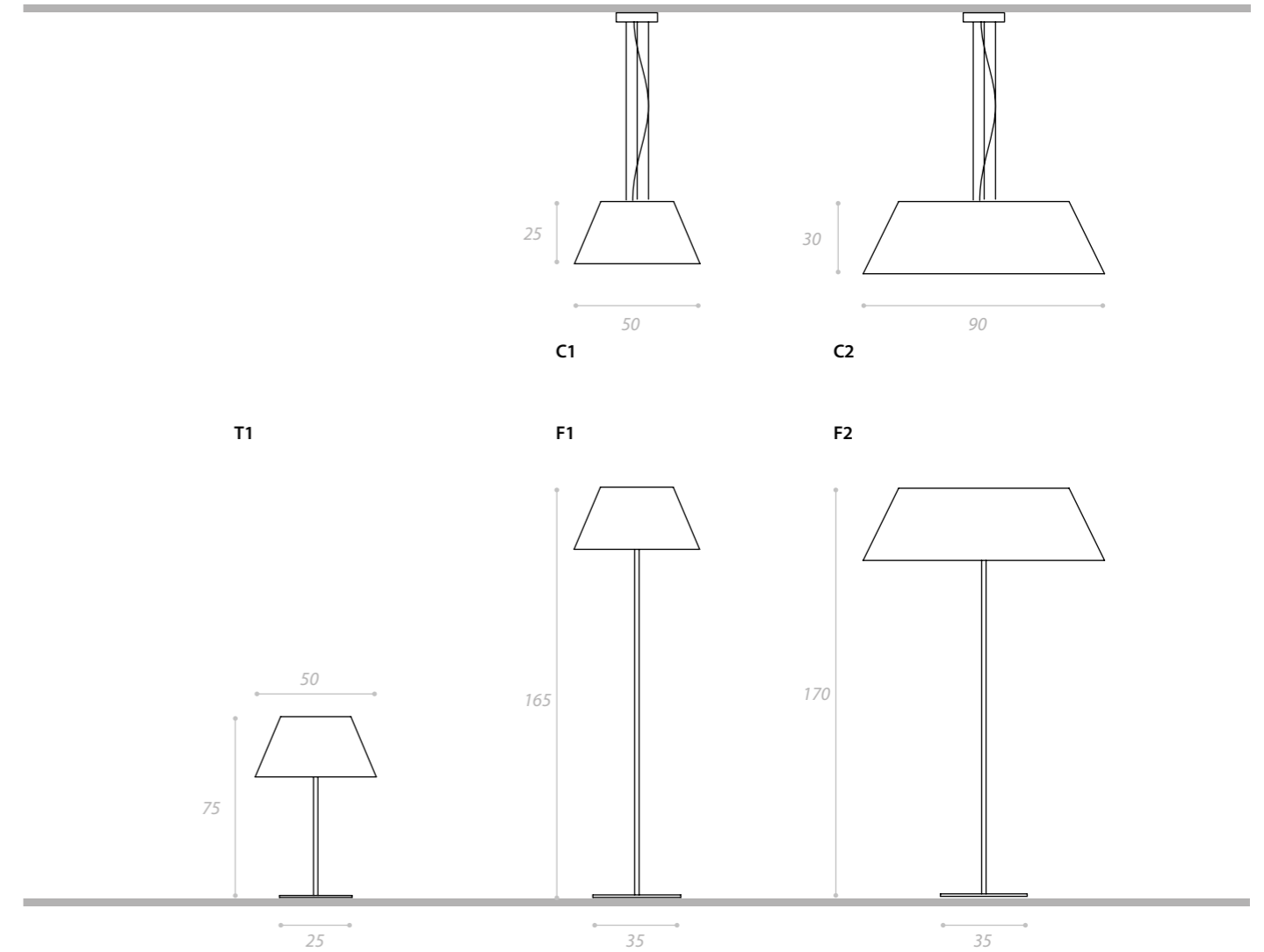

MATERIALI: metallo verniciato bianco o bronzo, vetroresina/
 MATERIAL: white or bronze painted metal, fiberglass

C1 } LED E27 20W 2500lm
 C2 }
 F1 } LED E27 20W 2500lm Dimmer included
 F2 }
 T1 }

CE C1/C2
 CE F1/F2/T1



MIAMI

design Giordana Arcesilai 2007



Un diffusore in vetroresina bianco caldo, che rappresenta l'icona classica del paralume, diffonde una luce morbida, accogliente e rassicurante. E' resistente all'urto, lavabile, di facile manutenzione, utilizzabile ovunque. Un cilindro di vetro borosilicato, all'interno del paralume, avvolge e scherma le fonti luminose per evitare abbagliamenti.

A warm white fiberglass diffuser, which is the classic icon of the lampshade, diffuses a soft, welcoming and reassuring light. It is impact-resistant, washable, easy to maintain and can be used anywhere. A cylinder of borosilicate glass, inside the lampshade, wraps and screens light sources to avoid dazzling.





130 Miami/ Lungarno 23/ Arch. Saverio Innocenti/ Florence

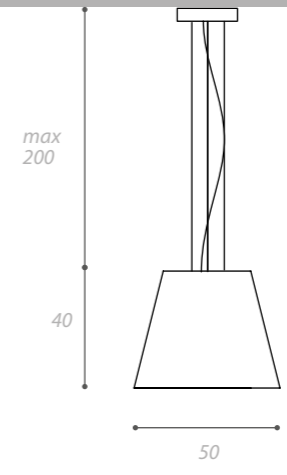

C1

Materiali: Vetrosina
Materials: Fiberglass

C1 LED E27 20W 2500lm

VETROSINA BIANCO CALDO
WARM WHITE FIBERGLASS



DOLCEVITA

design Gianfranco Marabese 2011



Lampada da terra con diffusore trasformabile. Attraverso la libera manipolazione, è possibile modellare e variare le dimensioni in altezza: personalizzando così il corpo della lampada e il suo effetto luminoso.

Floor lamp with transformable diffuser. Through the free manipulation, it is possible to model and vary the dimensions in height: thus personalizing the body of the lamp and its luminous effect.



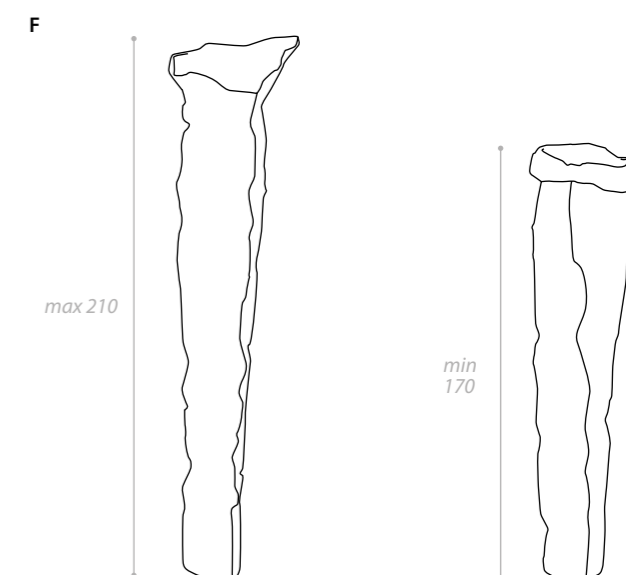

DOLCEVITA: CARATTERISTICHE TECNICHE DEL MATERIALE

- Riciclabilità
- Resistenza alla rottura / strappi
- Stabilità e Inalterabilità nel tempo
- Resistenza all'acqua / lavabile
- Resistenza alle alte e basse temperature
- Atossicità
- Resistenza agli agenti chimici
- Resistenza raggi UV

DOLCEVITA: TECHNICAL CHARACTERISTICS OF THE MATERIAL

- Recyclability
- Breaking strenght
- Stability and durability over time
- Water resistant – washable
- Resistance to high and low temperatures
- Non-toxic
- Resistance to chemicals
- UV resistance

F LED Par38 E27 16W 10° ◀ Dimmer included

MATERIALI: metallo e tyvek
MATERIAL: metal and tyvek

BIANCO/ WHITE

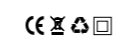

NOVECENTO

design Claudio Bitetti 2009



Da una ispirazione, che raccoglie una tradizione e la trasforma con ironia, nascono sospensioni uniche. L'aba-jour di memoria si confronta con il ready-made: l'oggetto e la sua trasformazione, per realizzazioni originali, personalizzate.

From an inspiration, which gathers a tradition and transforms it with irony, unique suspensions are born. The memory aba-jour confronts the ready-made: the object and its transformation, for original, personalized creations.



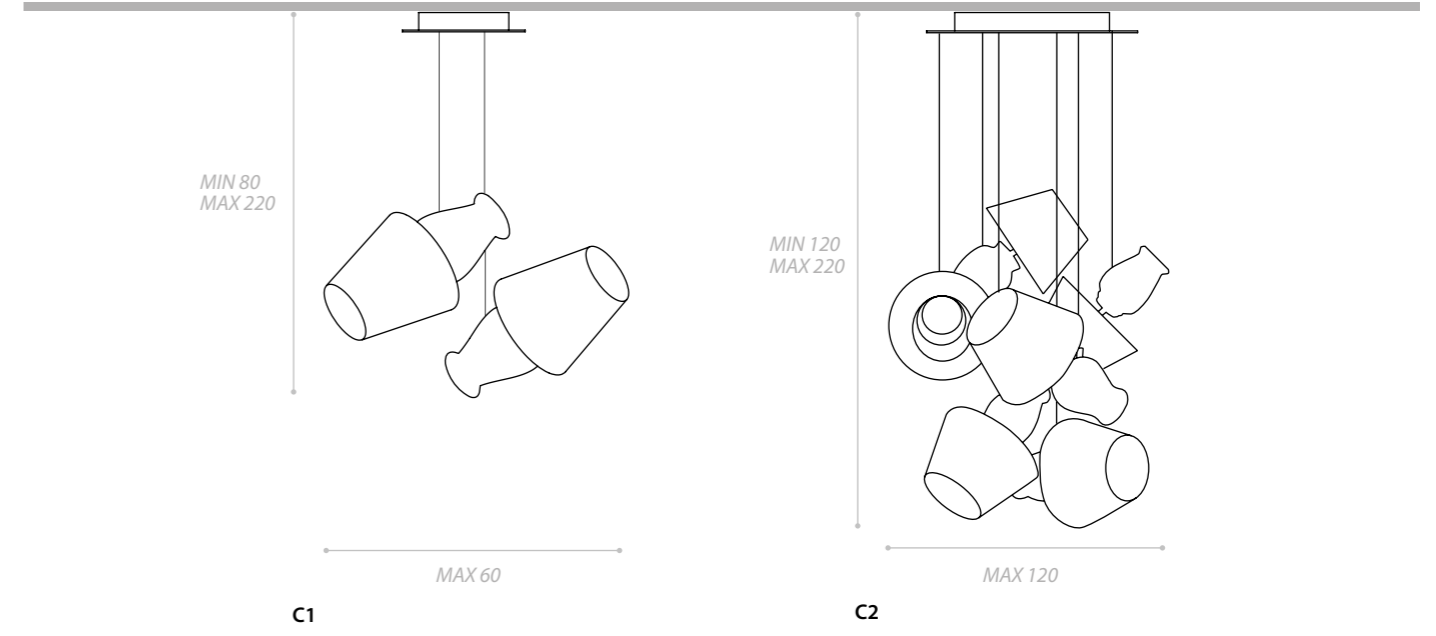

MATERIAL: ceramica, tessuto tecnopolimero oro
 MATERIAL: ceramic, white fabric, golden technopolymer

C1 2x LED E27 20W 2500lm (5000lm)
 C2 6x LED E27 20W 2500lm (15000lm)

CE

BIANCO/WHITE

OTTONE/BRASS



SOUL

design Romeo Guaricci 2019



Collezione che traduce forme iconiche in un oggetto dal segno innovativo, esclusivo, in grado di personalizzare ogni tipo di ambiente. La luce che diffonde, nasce dal contrasto tra volume e trasparenza, nell'accordo tra l'originale rivestimento a "tricot" e lo struttura in metallo che la sostiene.

Collection that translate iconic shapes into an object with an innovative, exclusive sign, able to personalize any type of environment. The light that it diffuses comes from the contrast between volume and transparency, in the agreement between the original "tricot" coating and the metal structure that supports it.



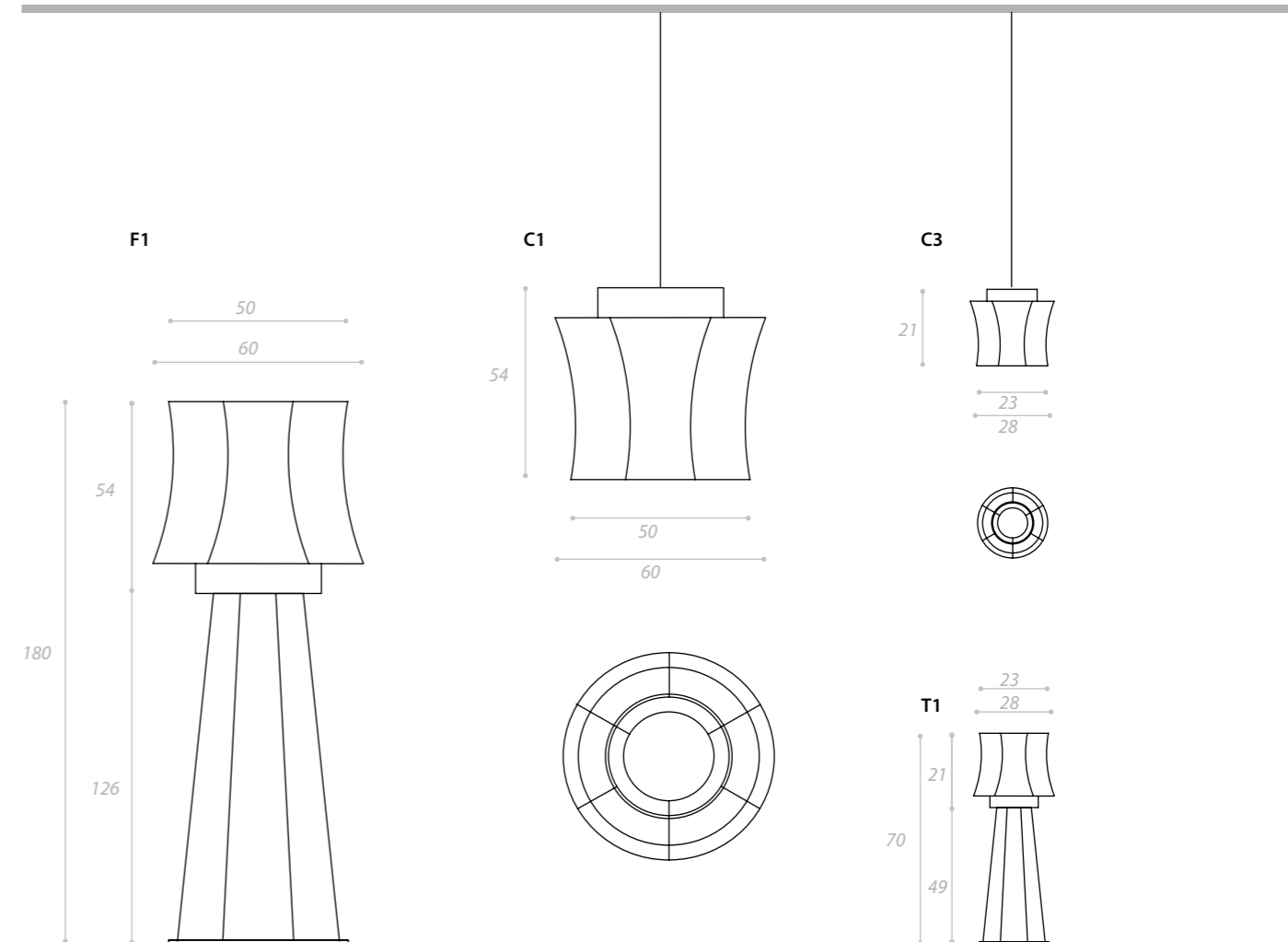

Le maglie Ecofibra sono un tessuto tecnico infrangibile, bio-compatibile ed estremamente resistente ai raggi UV: durevole e particolarmente adatto all'impiego outdoor. La presenza del vinile rende il tessuto impermeabile e lavabile in lavatrice a 30°: atossico e antibatterico.

The Ecofibra sweaters are an unbreakable, bio-compatible and extremely UV-resistant technical fabric: durable and particularly suitable for outdoor use. The presence of vinyl makes the fabric waterproof and machine washable at 30°: non-toxic and antibacterial.

MATERIALI: metallo e filo vinile
 MATERIAL: metal and vinyl thread

- F1 Led E27 2550 lm Dimmer included
- C1 Led E27 2550 lm
- C3 G9 Led
- T1 G9 Led

C1/C3

F1/T1

- BRONZO/ BRONZE
- BIANCO/ WHITE
- BLU/ BLUE
- ROSSO/ RED

FLAMBEAU

design Giordana Arcesilai 2017



Lampada da appoggio o da sospendere, ricaricabile, per un funzionamento autonomo, senza fili. La raffinata lavorazione in ottone o acciaio, fa filtrare la luce in modo suggestivo, creando effetti luminosi fortemente emozionali.

Standing or hanging lamp, rechargeable, for an autonomous wireless functioning. The refined workmanship in brass or steel, filters the light in a suggestive way, creating highly emotional lighting effects.





RICARICABILE. 12 Ore di luce senza fili
 RECHARGEABLE. 12 Hours of light without wires

MATERIALE: metallo/
 MATERIAL: metal

T1 LED 4W 400lm 

OTTONE/ BRASS 

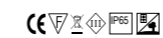

ACCIAIO/ STEEL 

LIBERA

design Gianfranco Marabese 2016



Lantern in three dimensions, with light source positioned inside the thin perimeter of metal, which defines its shape and gives a 'floating' effect to the light source.

Lantern in three dimensions, with light source positioned inside the thin perimeter of metal, which defines its shape and gives a "floating" effect to the light source.





F1

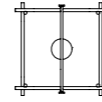

F2

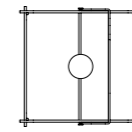

F3

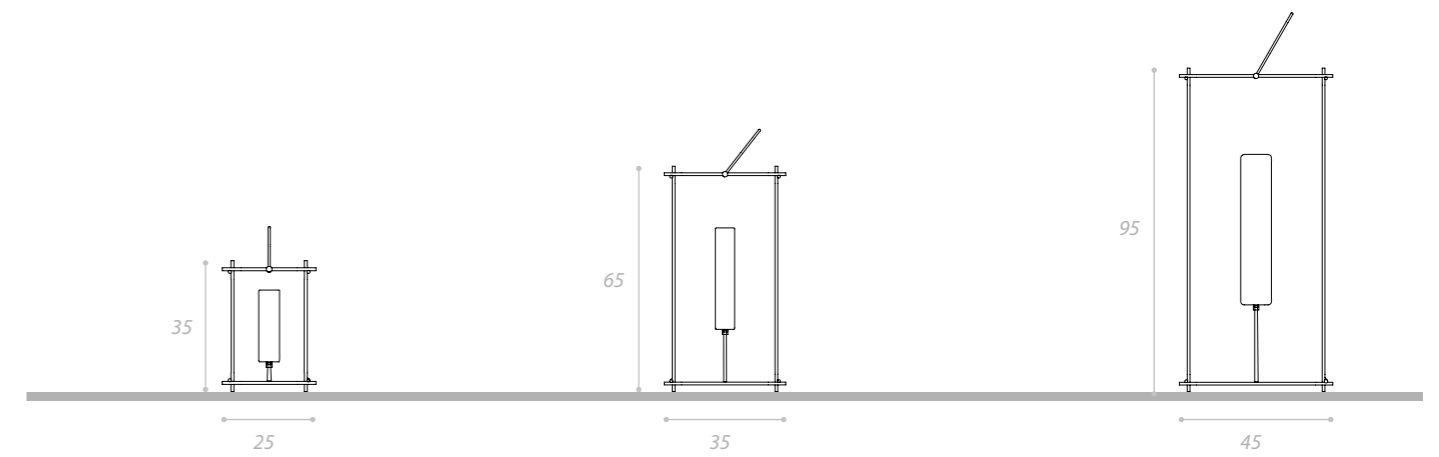
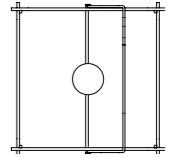

MATERIALE: metallo/
MATERIAL: metal.

F1] LED E14 6W 470lm
F2] LED E14 6W 470lm
F3] LED E27 20W 2500lm Dimmer included

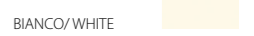

CU-BOX

design Gianfranco Marabese 2016



Proiettore di luce di dimensioni contenute per illuminare senza abbagliare.

Light projector with small dimensions to illuminate without dazzling.



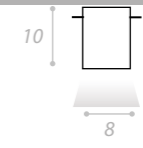

C1

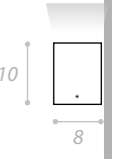

W1

C1 LED GU10 110/220V
W1 LED GU10 110/220V

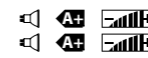

MATERIALE: alluminio/
MATERIAL: aluminium

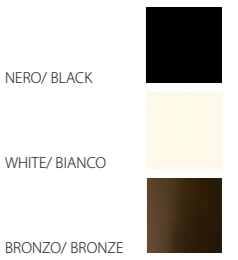

GONDOLA

design Mario Barbaglia 2000



Lampada a parete in pressofusione d'alluminio,
di forma avvolgente ed elegante, a luce indiretta.

Wall lamp in die-cast aluminium, with an enveloping
and elegant shape, with indirect light.



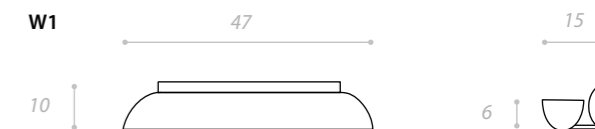



MATERIALE: metallo/
MATERIAL: metal

CROMO/ CHROME

ALLUMINIO/ ALUMINIUM

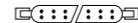

W1 Linear LED R7s 114mm 18W 110/230V 2000lm   



LINEA

design Oberon 1994/ R&S Antonangeli 2004



Lampada a parete orientabile, per illuminare specchi e quadri con una luce puntuale e dedicata.

Adjustable wall lamp, to illuminate mirrors and paintings with a timely and dedicated light.



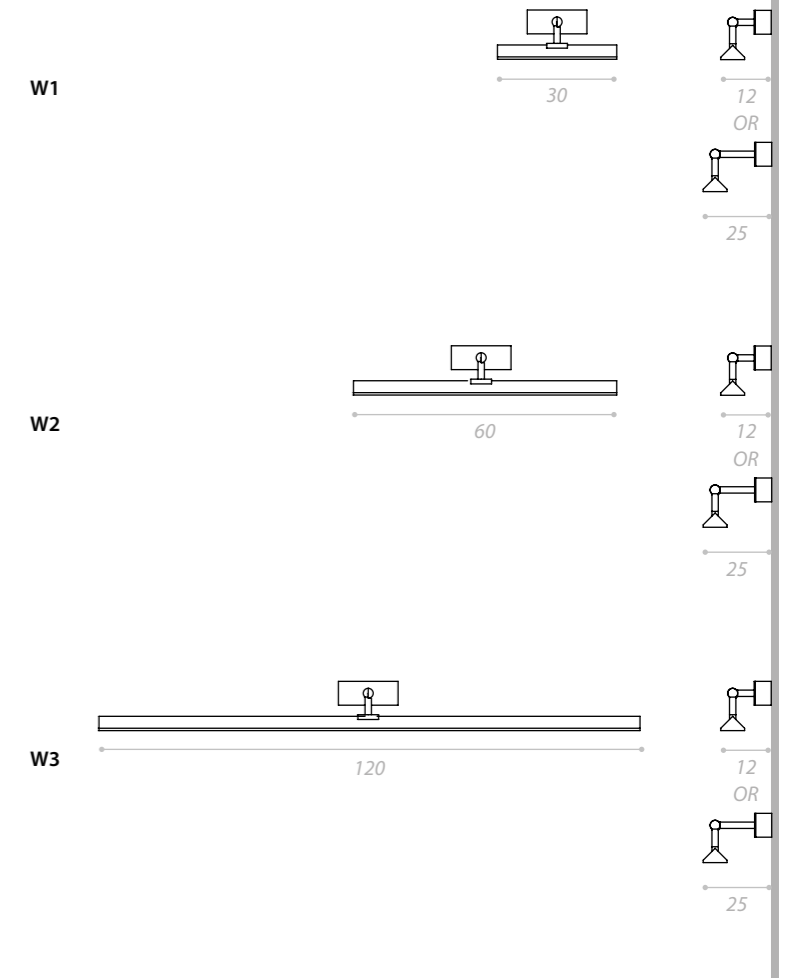

- W1** 2x Led GY6,35 12V (500lm)
- W2** 4x Led GY6,35 12V (1000lm)
- W3** 8x Led GY6,35 12V (2000lm)

- A++** Driver included
- A++** Driver included
- A++** Driver included

MATERIALE: metallo/
MATERIAL: metal



CE a richiesta/on demand

MAKE UP

design Gianfranco Marabese 2016

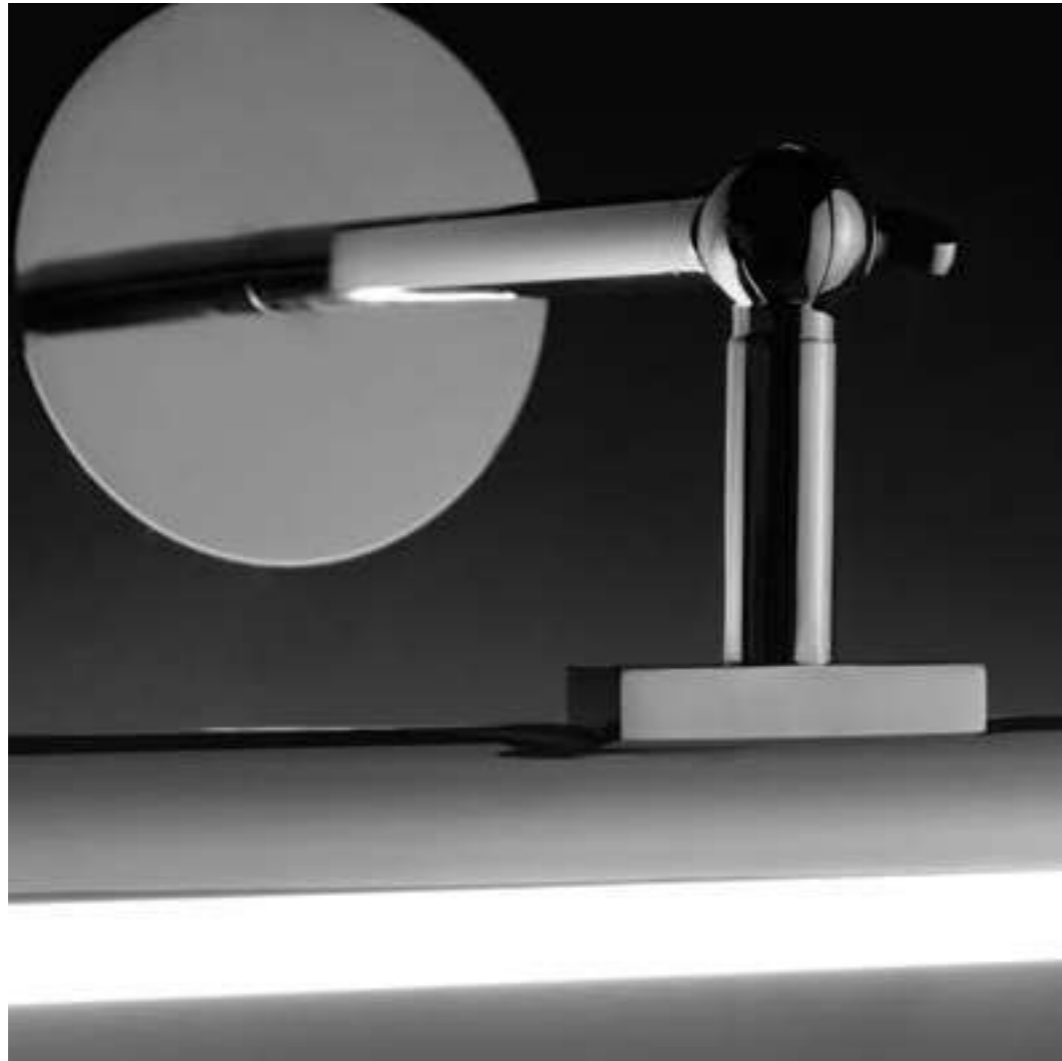

Lampada a parete orientabile per illuminare specchi, quadri con una luce puntuale e dedicata.

Adjustable wall lamp to illuminate mirrors, paintings with a timely and dedicated light.





W1

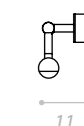
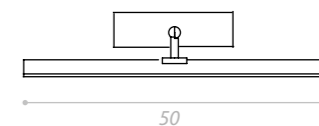

OR

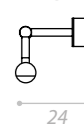

W3

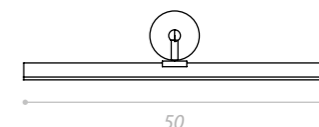

OR

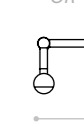

W2

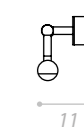
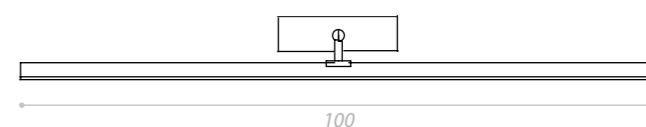

OR

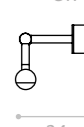

W4

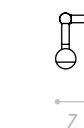
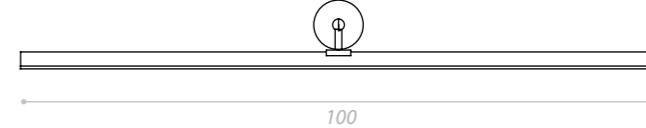

OR

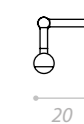

- W1 LED 15w/24v 1400Lm 3000°k Alimentatore incluso/Driver included
- W2 LED 30w/24v 2800Lm 3000°k Alimentatore incluso/Driver included
- W3 LED 15w/24v 1400Lm 3000°k Alimentatore remoto/Remote driver
- W4 LED 30w/24v 2800Lm 3000°k Alimentatore remoto/Remote driver



MATERIALE: alluminio/
MATERIAL: aluminium

CROMO/ CHROME



FLEX

design Claudio Bitetti 2007

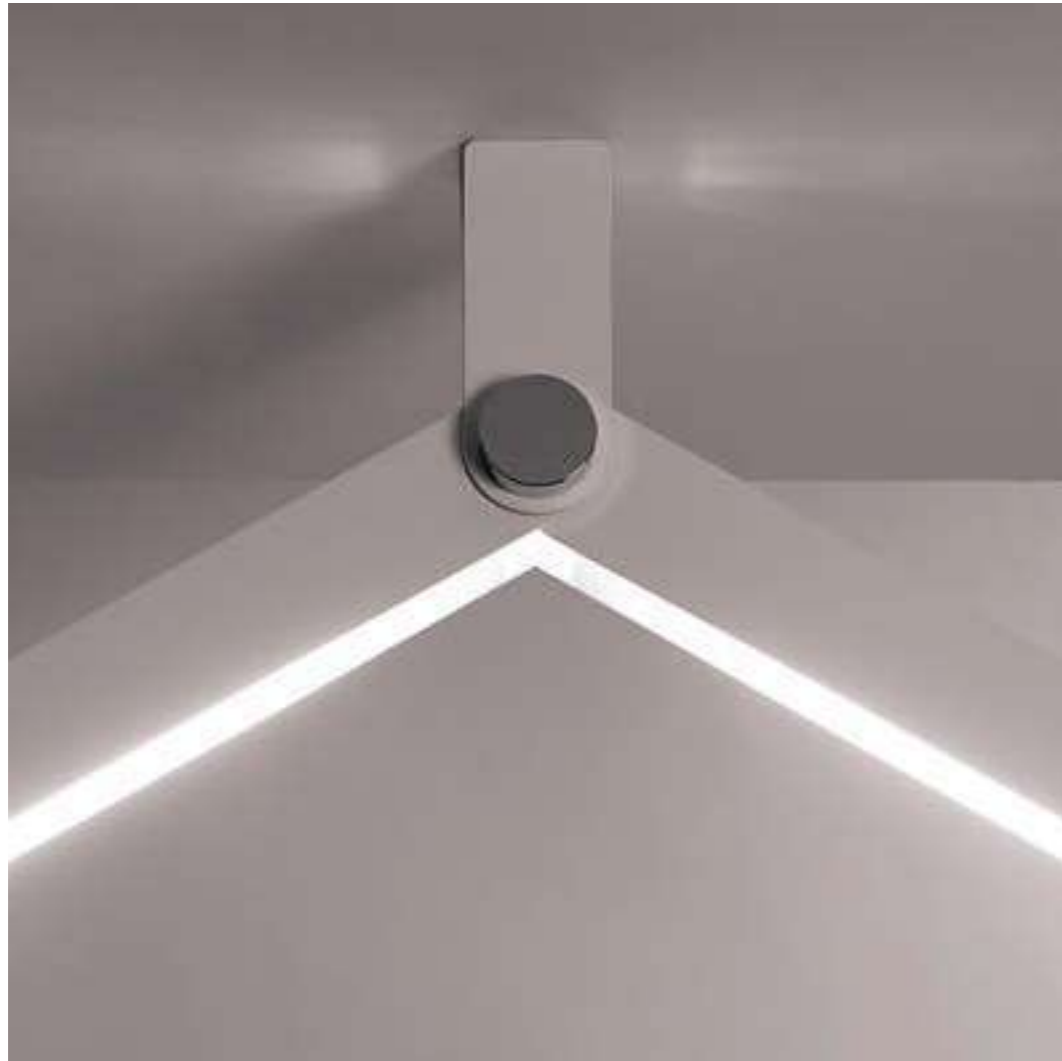

Sistema di luce dinamico, che utilizza due bracci in due dimensioni, collegati tra loro attraverso uno snodo. Ruotabili a 180° i bracci permettono di illuminare secondo le necessità che mutano, anche quotidianamente. sospensione.

Dynamic light system, which uses two arms in two dimensions, connected to each other through a joint. The arms can be rotated through 180° to illuminate according to changing needs, even daily.







FLEX

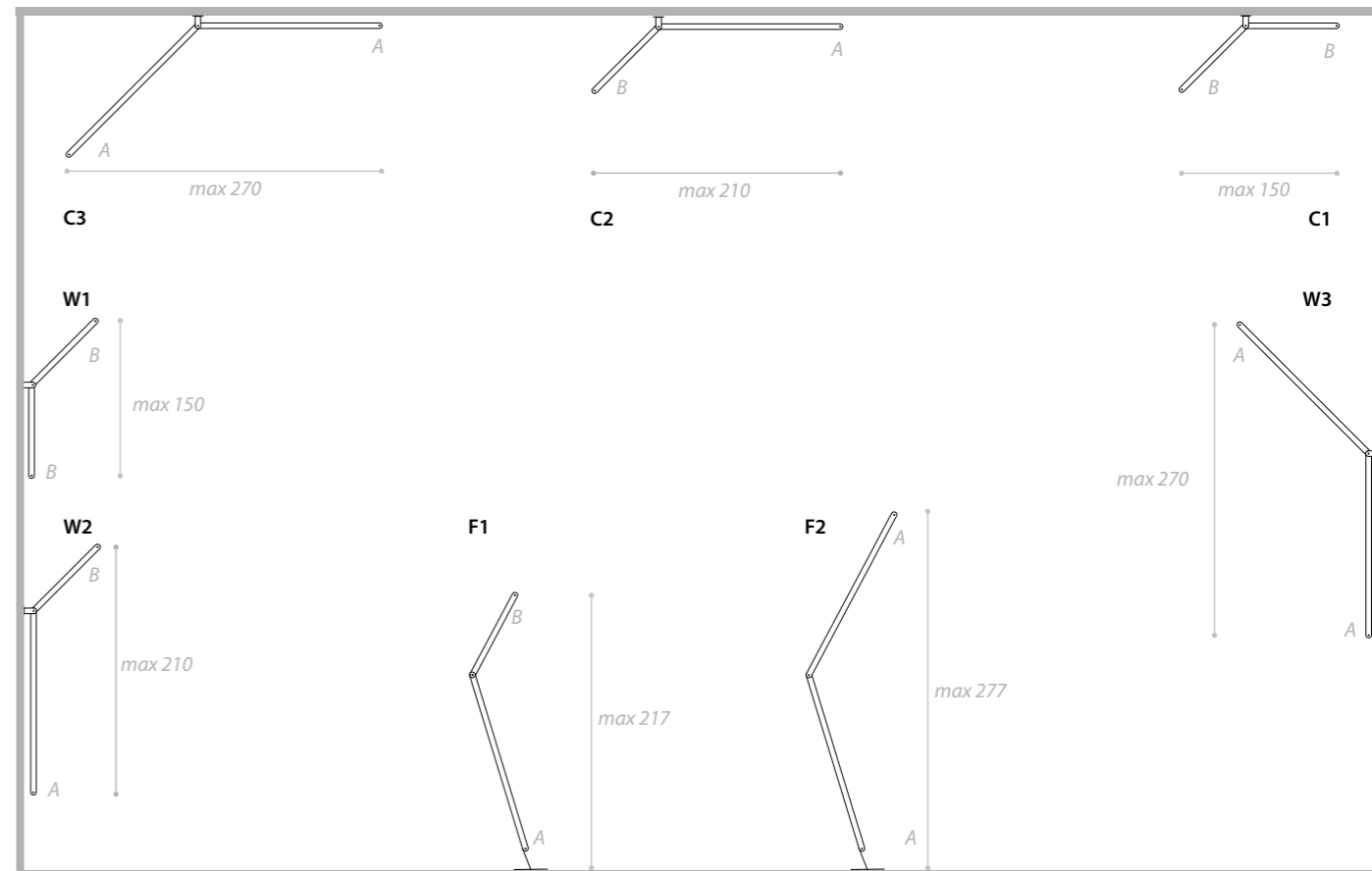

FLEX Barra

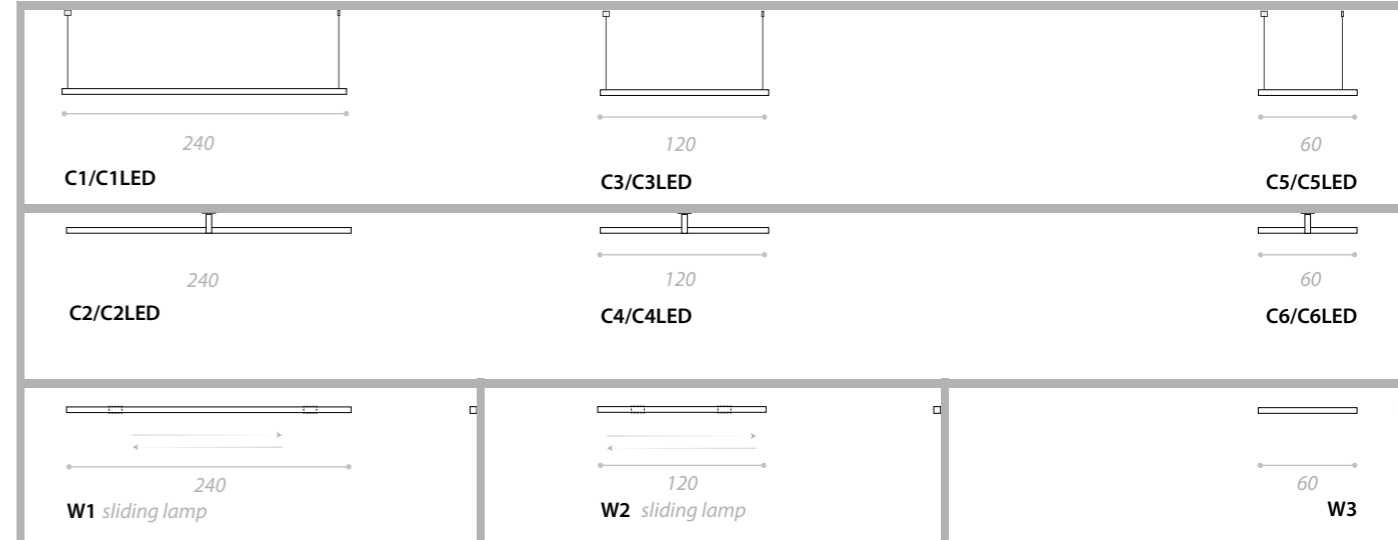

FLEX

- C1 } 2x Fluo T5 24W 1750lm
 - W1 } 2x Fluo T5 24W 1750lm
 - C2 } Fluo T5 54W 4450lm + Fluo T5 24W 1750lm
 - W2 } Fluo T5 54W 4450lm + Fluo T5 24W 1750lm
 - C3 } 2x Fluo T5 54W 4450lm
 - W3 } 2x Fluo T5 54W 4450lm
 - F1 } Fluo T5 54W 4450lm + Fluo T5 24W 1750lm
 - F2 } 2x Fluo T5 54W 4450lm
- Dimmer su richiesta/
 Dimmer on demand

CE

FLEX Barra

- C1 } 2x Fluo T5 54W 4450lm
- C2 } 1x Fluo T5 54W 4450lm
- C3 } 1x Fluo T5 54W 4450lm
- C4 } 1x Fluo T5 54W 4450lm
- C5 } 1x Fluo T5 54W 4450lm
- C6 } 1x Fluo T5 54W 4450lm
- W1 LED } LED 24V 70W 8000lm
- C2 LED } LED 24V 70W 8000lm
- W1 LED } LED 24V 33W 3800lm
- C3 LED } LED 24V 33W 3800lm
- C4 LED } LED 24V 33W 3800lm
- W2 LED } LED 24V 14,5W 1650lm
- C5 LED } LED 24V 14,5W 1650lm
- C6 LED } LED 24V 14,5W 1650lm
- W3 LED } LED 24V 14,5W 1650lm

Materiali: Metallo
Materials: Metal

NERO/BLACK

BIANCO/WHITE

OUTDOOR
COLLECTION



SOUL

design Romeo Guaricci 2019



Collezione che traduce forme conosciute, in un oggetto dal segno innovativo, esclusivo, in grado di personalizzare ogni tipo di ambiente. La luce che diffonde, nasce dal contrasto tra volume e trasparenza, nell'accordo tra l'originale rivestimento a 'tricot' e lo scheletro in metallo che la sostiene.

Collection that translate iconic shapes into an object with an innovative, exclusive sign, able to personalize any type of environment. The light that it diffuses comes from the contrast between volume and transparency, in the agreement between the original "tricot" coating and the metal structure that supports it.





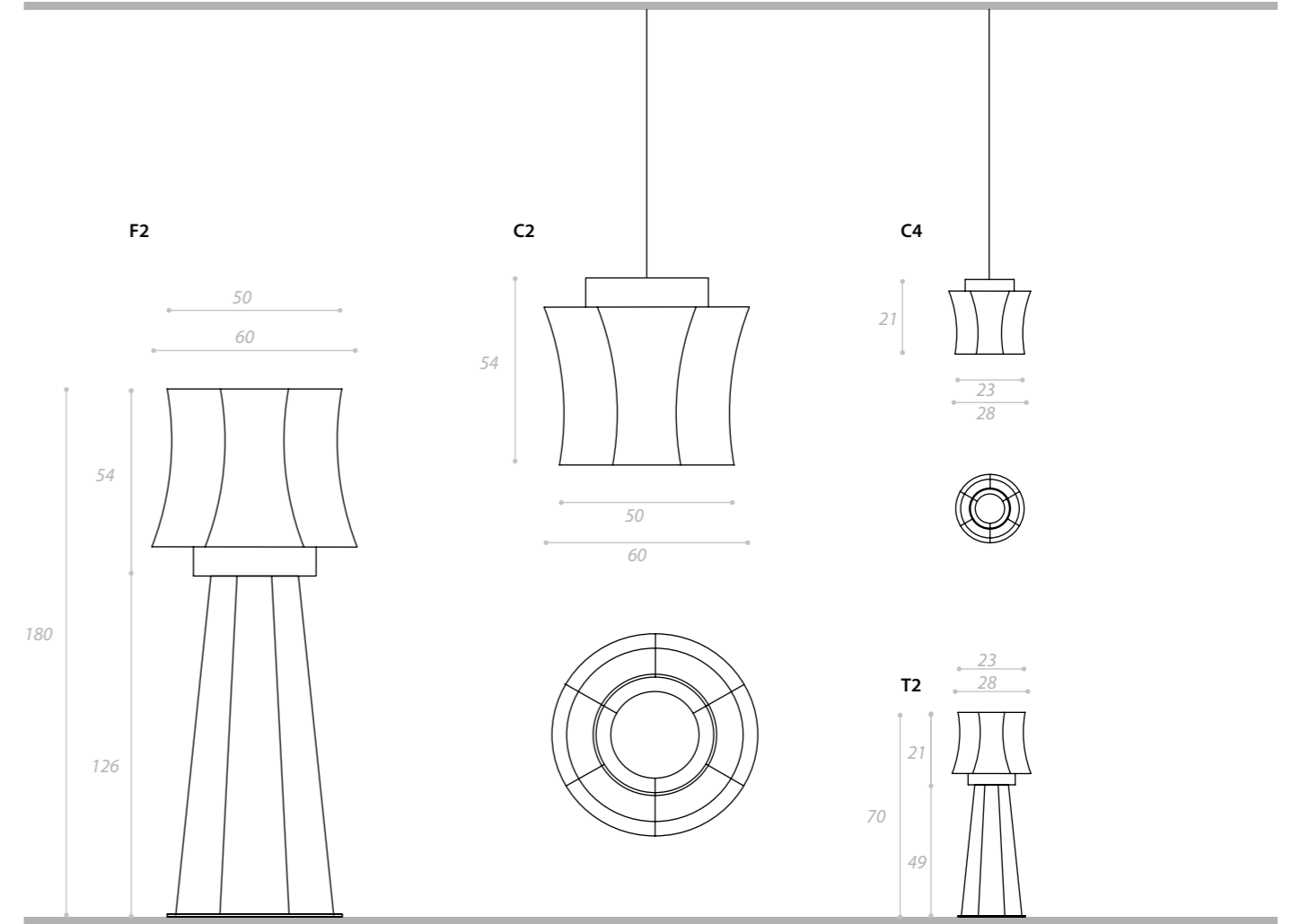

Le maglie Ecofibra sono un tessuto tecnico infrangibile, bio-compatibile ed estremamente resistente ai raggi UV: durevole e particolarmente adatto all'impiego outdoor. La presenza del vinile rende il tessuto impermeabile e lavabile in lavatrice a 30°: atossico e antibatterico.

The Ecofibra sweaters are an unbreakable, bio-compatible and extremely UV-resistant technical fabric: durable and particularly suitable for outdoor use. The presence of vinyl makes the fabric waterproof and machine washable at 30°: non-toxic and antibacterial.

MATERIALI: metallo e filo vinile
 MATERIAL: metal and vinyl thread

- F2 Led E27 2550 lm
- C2 Led E27 2550 lm
- C4 G9 Led
- T2 G9 Led



BRONZO/ BRONZE

BIANCO/ WHITE

BLU/ BLUE

ROSSO/ RED

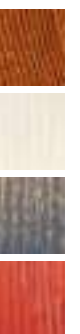

MIAMI

design Giordana Arcesiali 2007



Collezione che nasce per portare all'esterno l'atmosfera della luce degli interni. Un paralume in vetroresina bianco caldo, diffonde una luce morbida, accogliente. Il disegno essenziale della struttura, esalta la semplicità del diffusore, pensato e prodotto per essere resistente alle intemperie e agli sbalzi di calore.

Collection that was created to bring the atmosphere of interior light to the outside. A warm white fibreglass shade diffuses a soft, welcoming light. The essential design of the structure, enhances the simplicity of the diffuser, designed and produced to be resistant to weather and sudden changes in heat.









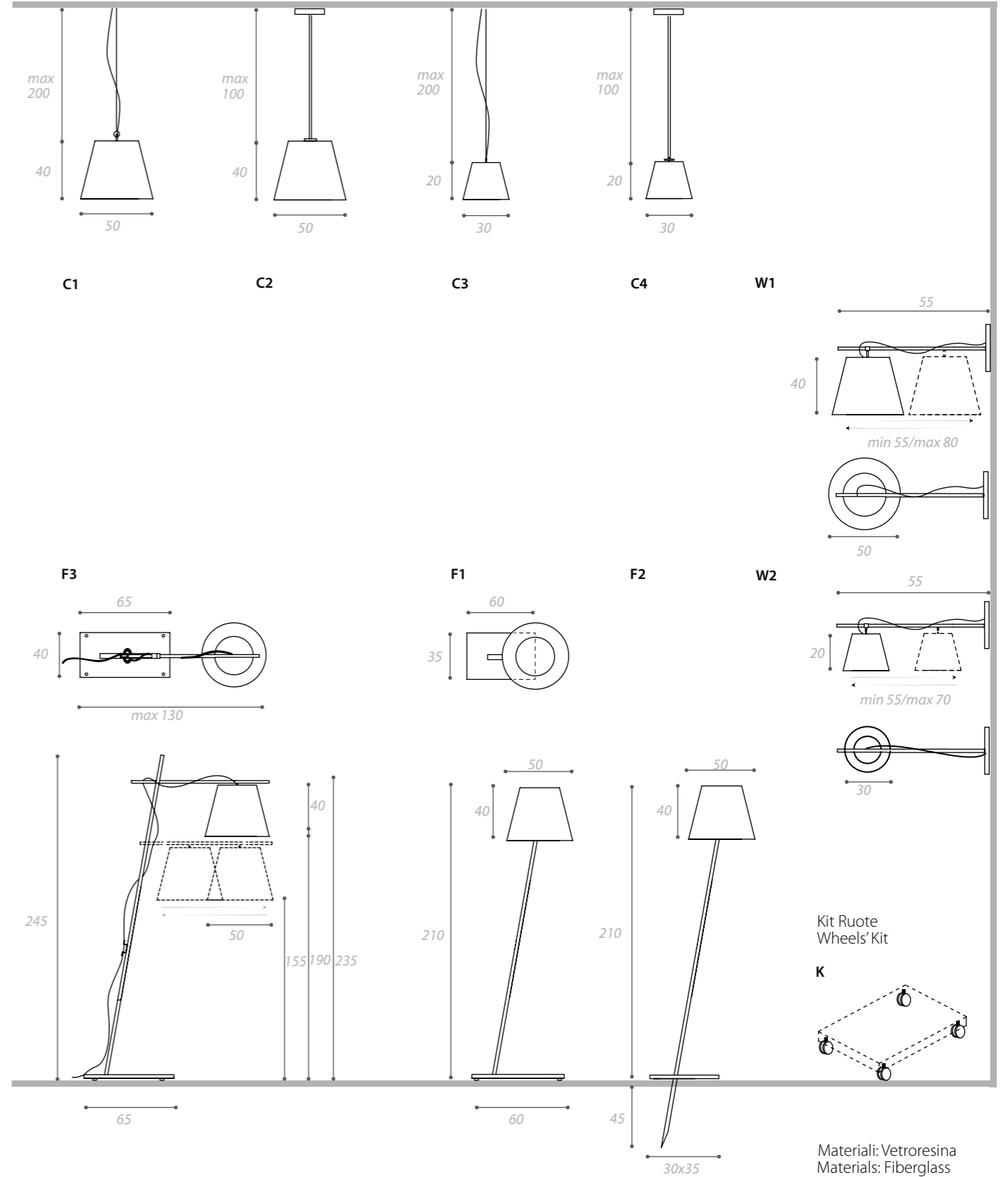

Materiali: Vetroresina
Materials: Fiberglass

MATERIALE PER STRUTTURA/
MATERIAL FOR STRUCTURE

- ACCIAIO/ INOX
- OTTONE/ BRASS

MATERIALE PER LA BASE/
BASE MATERIAL

- SERIZZO/ STONE
- LAVA/ LAVA

LED E27 20W 2500lm 110/220V



NOTTAMBULA

design Gianfranco Marabese 2009



Lantern in vetroresina bianco caldo, che porta negli spazi esterni, intime atmosfere. L'alta resistenza agli urti e la facilità di pulizia, ne permettono un utilizzo universale.

Warm white fiberglass lantern that brings intimate atmospheres to outdoor spaces. The high impact resistance and ease of cleaning allow universal use.



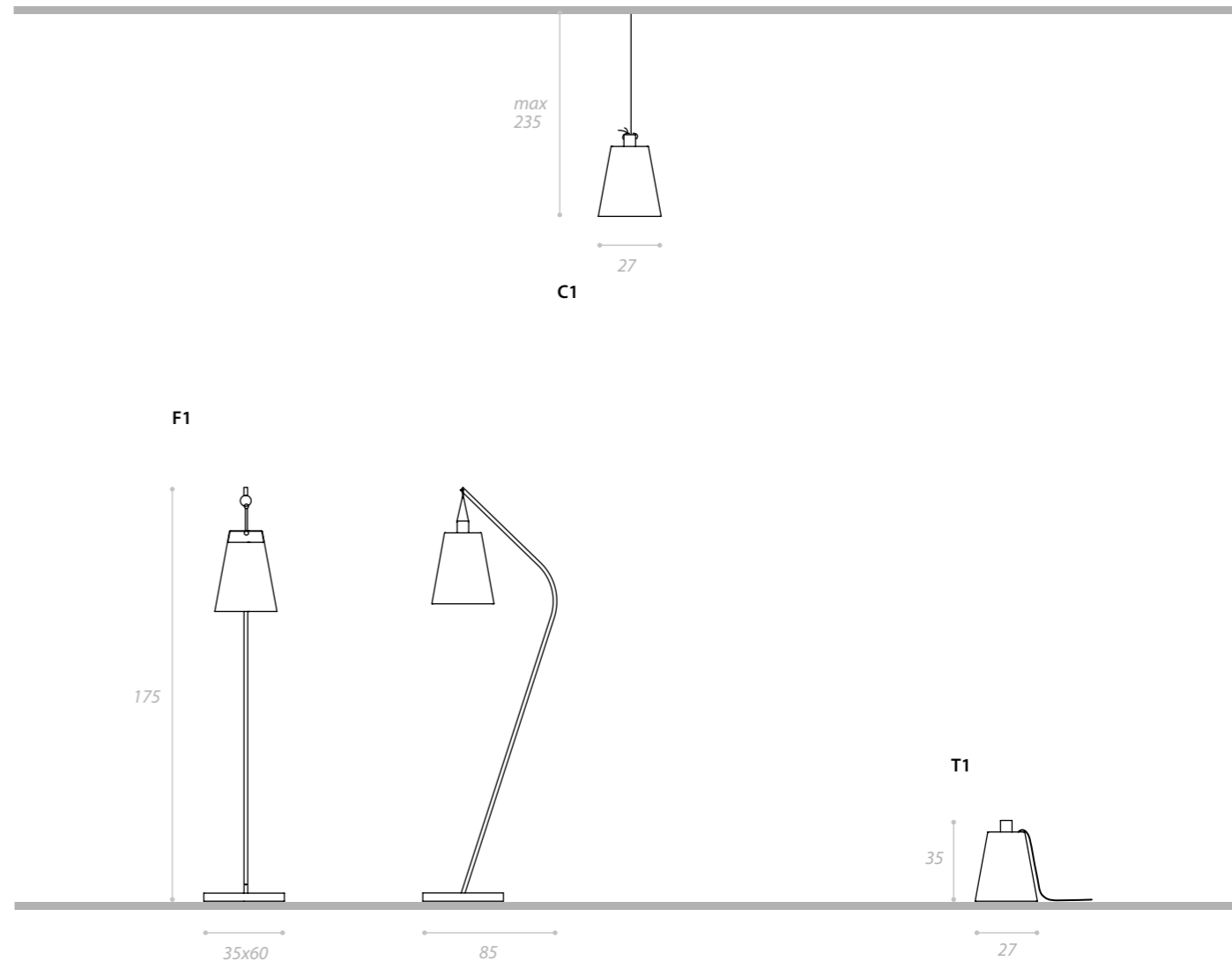

MATERIALI: struttura rame, base in lava
 MATERIALS: copper structure, lava base

C1 }
 F1 } LED G9 110/230V 4W 280lm 3000°k
 T1 } **A+**

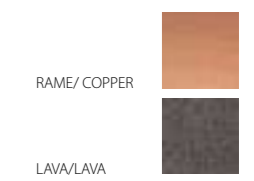

RICAMI

design Gianfranco Marabese 2009



Collezione di lampade a paralume, con diffusore in vetroresina bianco caldo, di diverse dimensioni e soluzioni tipologiche: resistente all'urto, lavabile, di facile manutenzione. Un cilindro di vetro borosilicato, all'interno del paralume, avvolge e scherma le fonti luminose per evitare abbagliamenti.

Collection of lampshades with diffuser in warm white fiberglass, of different sizes and typological solutions: impact resistant, washable, easy to maintain. A cylinder of borosilicate glass, inside the lampshade, wraps and screens light sources to avoid dazzling.





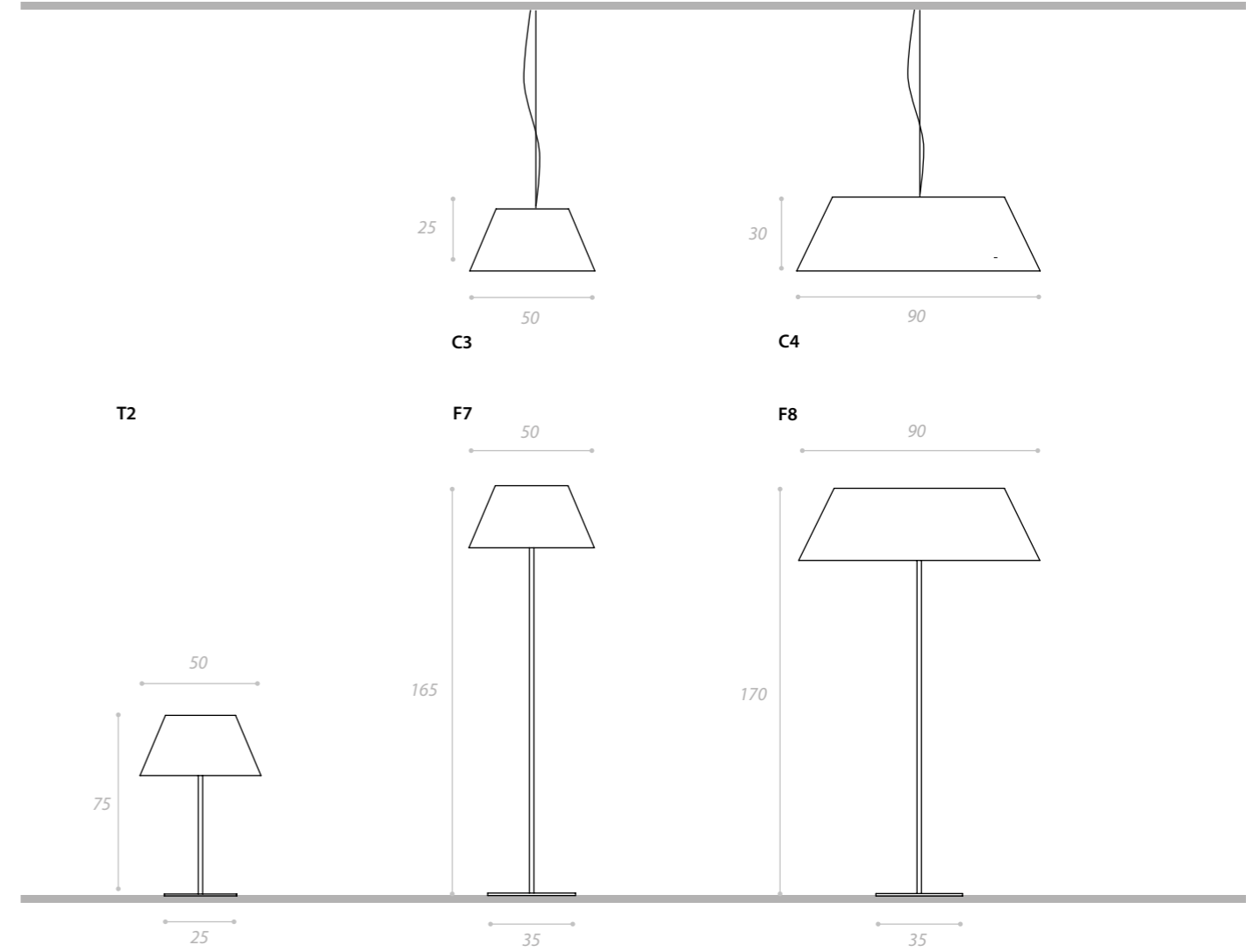

C3
C4
F7
F8
T2

LED E27 20W 2500lm

C1/C2F1/F2/T1

MATERIAL: vetroresina.
MATERIAL: fiberglass

BIANCO/WHITE

BRONZO/BRONZE



POLLICINO

design Giordana Arcesiali 2007



Lampada che nasce come segna-passo e luce d'accento orientabile per evidenziare alberi, sculture, architetture. Si utilizza appoggiata al suolo, singolarmente o collegata in sequenza. Può essere impiegata anche in interno, come luce di cortesia o come accento per le piante domestiche.

Lamp that was born as a step-maker and adjustable accent light to highlight trees, sculptures, architecture. It is used resting on the ground, singularly or connected in sequence. It can also be used indoors, as a courtesy light or as an accent for domestic plants.







F1/F2

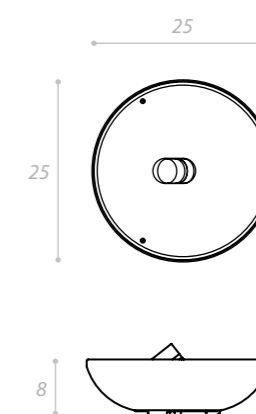

F3/F4

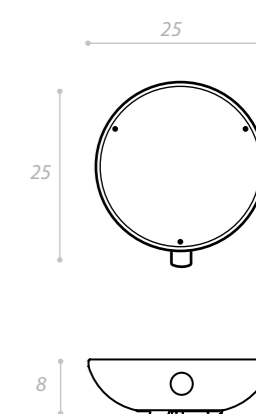

F1 }
 F2 } 2 LED 350mA 1W cad. **A+** Driver remoto
 F3 }
 F4 }

☑️☑️☑️ Vedere collegamenti e alimentatori pag. 218/ links and converter on page 218

MATERIALE: alluminio/
 MATERIAL: aluminium

ALLUMINIO/ ALUMINIUM

BRONZO/BRONZE



I SNAP

R&S Antonangeli 2007



Lampada costituita da una asta in rame duttile, che permette di direzionare la luce a LED ed ottenere gli effetti luminosi desiderati. Utilizzabile singolarmente o in aggregato, per esilità visiva e dimensioni della fonte luminosa, è ideale per l'illuminazione di piante in vaso o cespugli. Il rame, non trattato, consente, grazie alla naturale ossidazione, un'integrazione formale e visiva con i rami delle piante e il paesaggio.

Lamp consisting of a ductile copper rod, which allows to direct the LED light and obtain the desired lighting effects. It can be used singularly or in aggregate, due to the visual slenderness and size of the light source, it is ideal for lighting potted plants or bushes. Untreated copper allows, thanks to natural oxidation, a formal and visual integration with plant branches and the landscape.



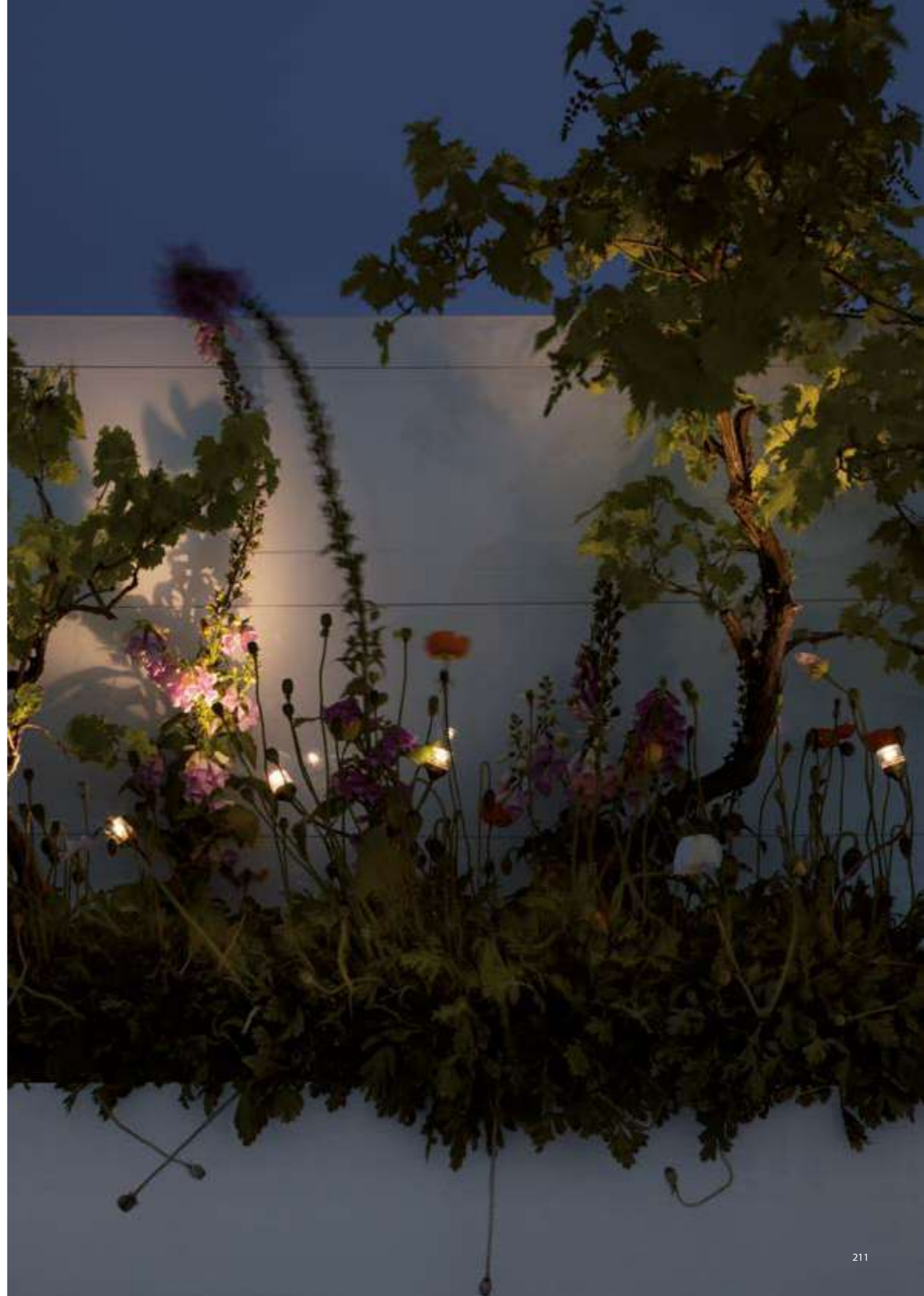



W1

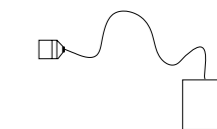

W2

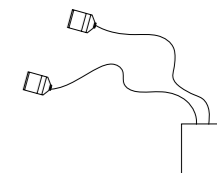

F1 F2 F3 F4 F5 F6 F7 F8

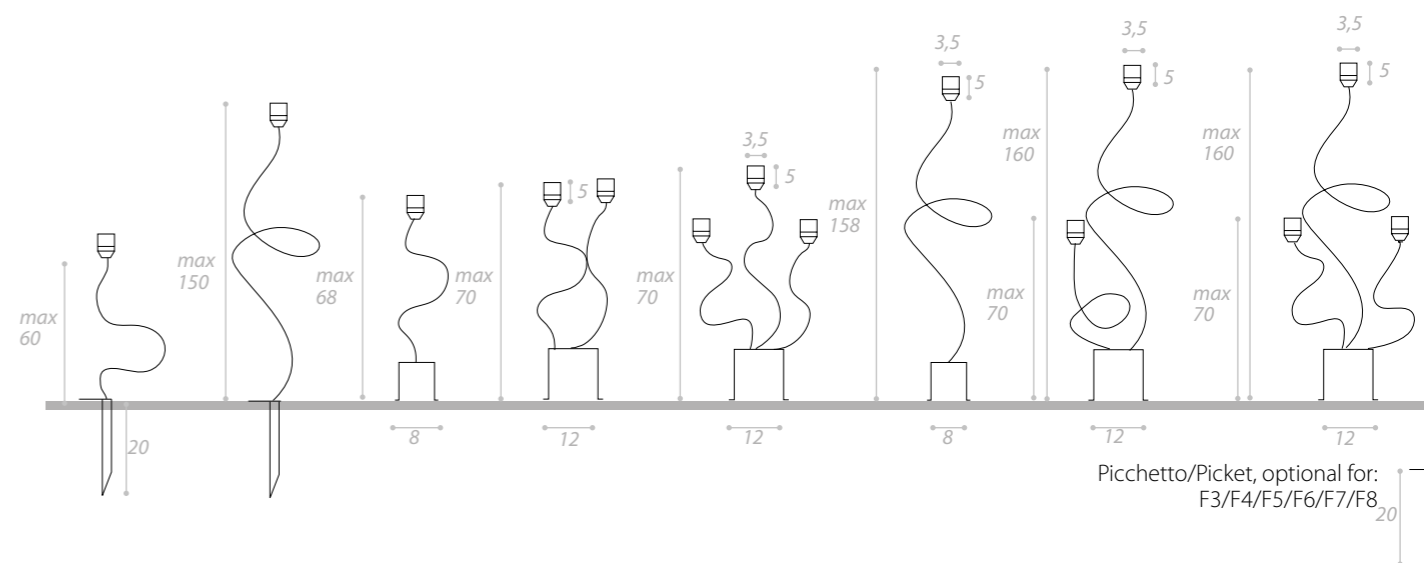

Picchetto/Picket, optional for:
F3/F4/F5/F6/F7/F8

MATERIALE: rame duttile/
MATERIAL: copper

F3/F4/F5/F6/F7/F8/W1/W2 Alimentatore incorporato IP67/ Inside driver
 F1/F2 Alimentatore non incluso/ Driver not included
 Ogni spot genera 160lm/Each spot develops 160lm $\angle 40^\circ$
 Per le versioni in colore ambra corrente max/for amber version current max 350mA
 F1/F2 Vedere collegamenti e alimentatori pag. 218/ links and converters on page 218
 LED 3W 700mA



RAMME/ COPPER



CROMO PER W1, W2/
CHROME FOR W1, W2



TWINLED

R&S Antonangeli 2008



Spot a doppia emissione di luce, orientabile, che consente di ottenere due coni luminosi contrapposti, per luci d'accento e segnalazione percorsi.

Spotlight with double light emission, adjustable, which allows to obtain two opposing light cones, for accent lighting and signaling paths.

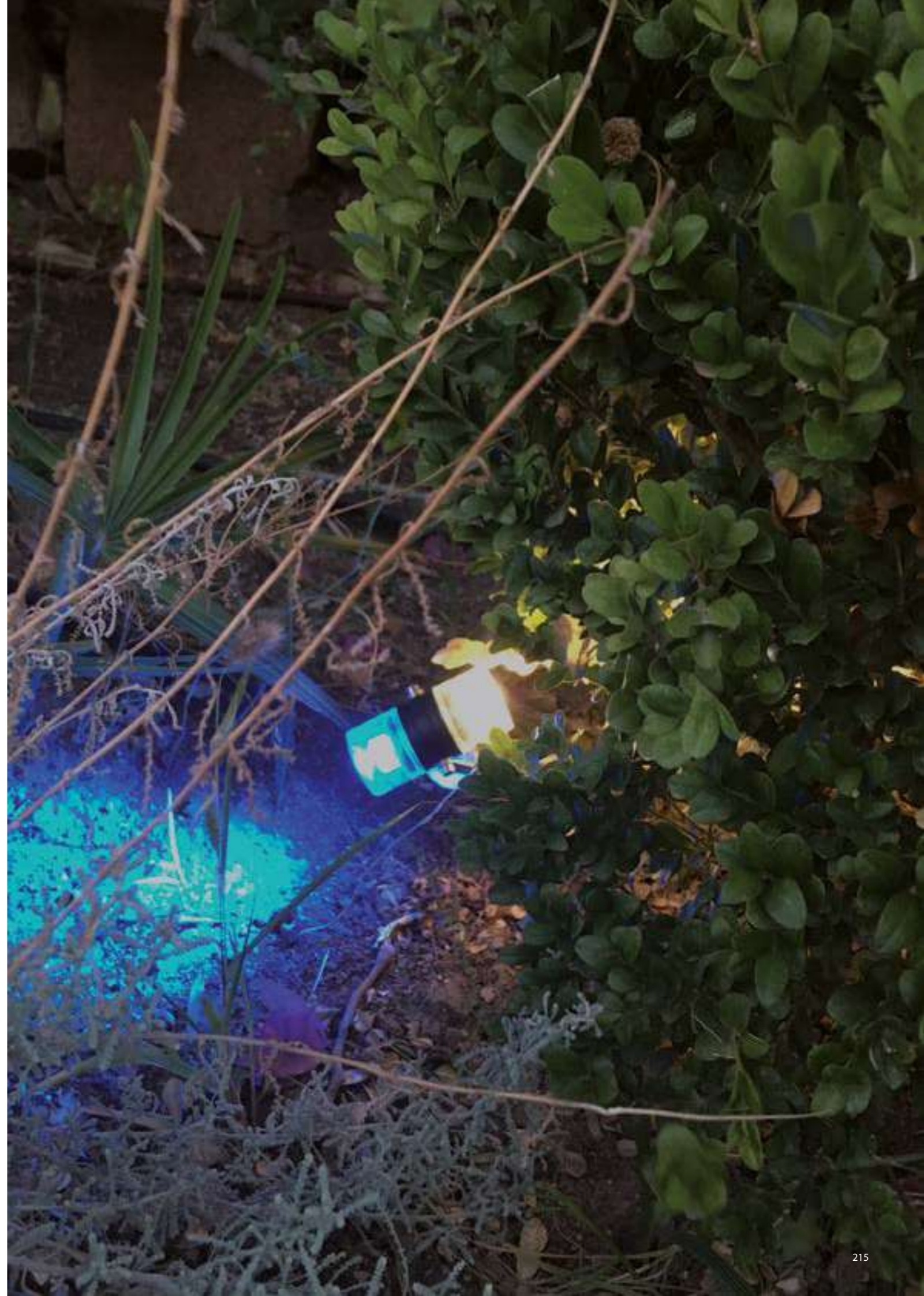

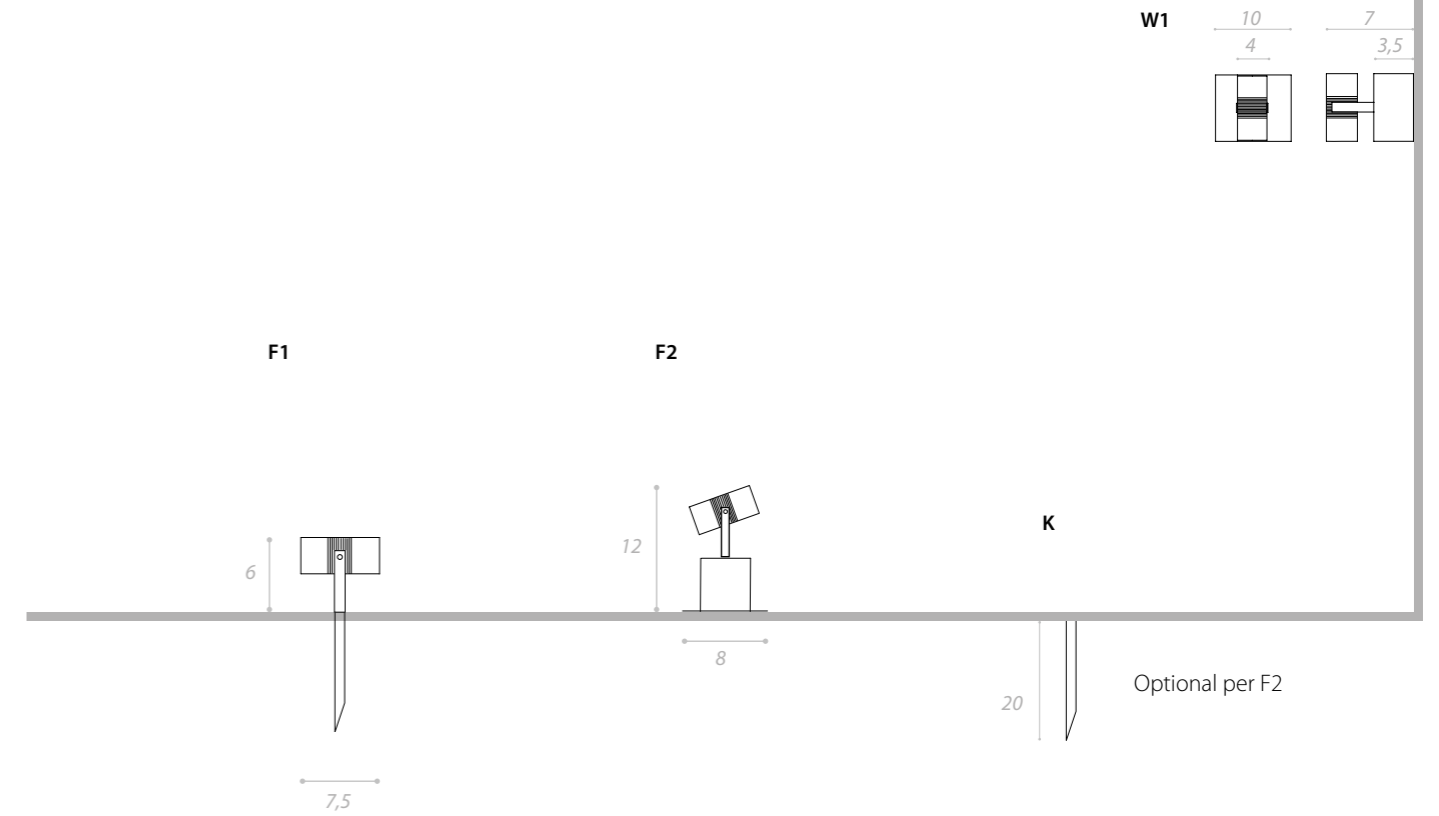

Optional per F2

MATERIALE: metallo/
MATERIAL: metal.

W1 350mA 2LED 1W cad Alimentatore incluso IP67/Driver included  Su richiesta/On demand
F2 350mA 2LED 1W cad Alimentatore non incluso/Driver not included
F1 350mA 2LED 1W cad Alimentatore non incluso/Driver not included

  Vedere collegamenti e alimentatori pag. 218/ links and converters on page 218



POLLICINO/I-SNAP/TWINLED

Sistema di alimentazione e processo di connessione
 Converter system joining and Connecting process

Processo di connessione a pulsante - Morsetto rapido Connecting process with terminal connecting button



Prendere il pulsante di connessione in dotazione
 Take the connection button given as equipment



Infilare i cavi senza splelarli a filo del suo contenitore
 Insert the wires without stripping them



Accertarsi che siano infilati fino in fondo
 Be sure that the wires are inserted till the end



Con una pinza premere il pulsante arancio
 Using a tool to push the button till the connector's blade



Dal foro uscirà un gel trasparente che preserverà la connessione dall'umidità
 From the insertion's hole come out a transparent gel that will protect the electrical connection from the umidity



Prendere il pulsante di connessione in dotazione
 Take the connection button given as equipment

Sistema di alimentazione in aggregato di più corpi illuminanti Converter system joining several lighting elements

Punto di connessione elettrica con morsetto rapido a pulsante
 Electrical connecting point with button connecting terminal

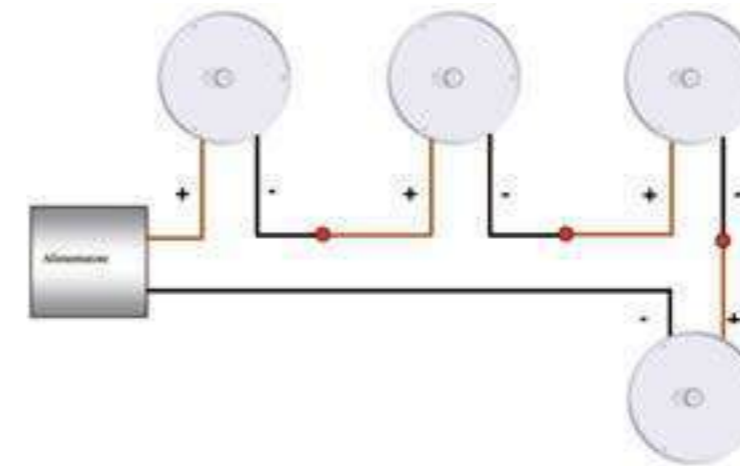

Pollicino

- AI2: alimentatore per max 4 lampade 500mA, 8 LED 2W cad
- AI2: converter x max 4 lamps 500mA, 8 LED 2W cad
- AI3: alimentatore IP67 per max 2 lampade 350mA, 4 LED 1W cad
- AI3: converter IP67 x max 2 lamps 350mA, 4 LED 1W cad
- AI4: alimentatore IP67 per max 4 lampade 350mA, 8 LED 1W cad
- AI4: converter IP67 x max 4 lamps 350mA, 8 LED 1W cad
- AI5: alimentatore IP67 a doppia linea per max 12 lampade (6 per linea) 350mA 24LED 1W cad
- AI5: converter IP67 double line x max 12 lamps (6 for line) 350mA, 24 LED 1W cad

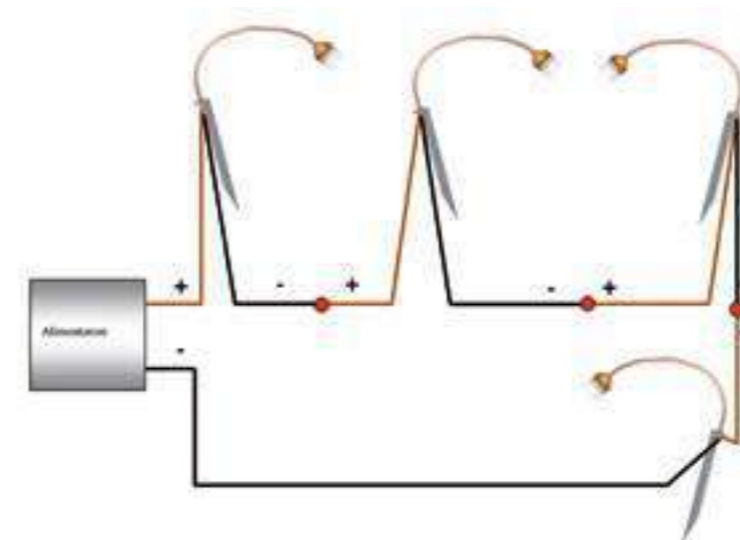

I-Snap F1/F2

- AI1: alimentatore a spina x 3 lampade 500mA, 3 LED 2W cad
- AI1: plug converter x 3 lamps 500mA, 3 LED 2W cad
- AI2: alimentatore per min 3 max 8 lampade 500mA, 8 LED 2W cad
- AI2: converter x min 3 max 8 lamps 500mA, 8 LED 2W cad
- AI6: alimentatore IP67 x max 2 lampade 700mA, 2 LED 3W cad
- AI6: converter IP67 x max 2 lamps 700mA, 2 LED 3W cad
- AI7: alimentatore IP67 x max 4 lampade 700mA, 4 LED 3W cad
- AI7: converter IP67 x max 4 lamps 700mA, 4 LED 3W cad
- AI5: alimentatore IP67 per min 8 max 12 lampade 700mA 12LED 3W cad
- AI5: converter IP67 x min 8 max 12 lamps 700mA 12 LED, 3W cad
- AI8: alimentatore per singolo led 700 mA
- AI8: driver for a single led 700 mA

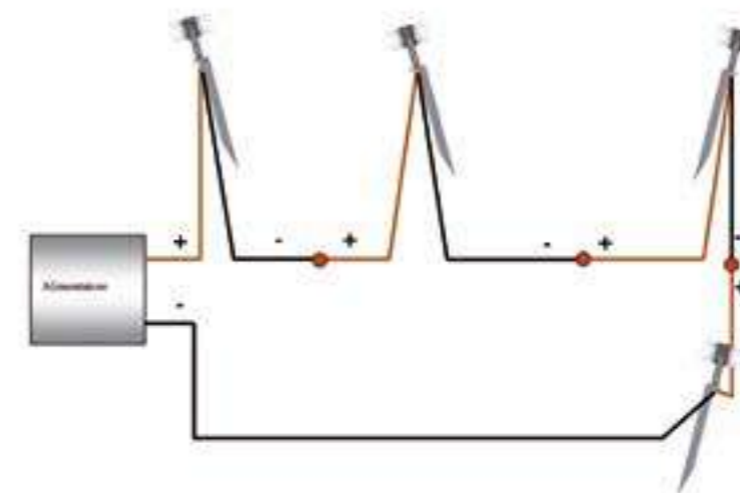

Twinled: F1 picchetto/picket

- AI1: alimentatore a spina x 1 lampada 500mA, 2 LED 2W cad
- AI1: plug converter x 1 lamp 500mA, 2 LED 2W cad
- AI2: alimentatore per max 4 lampade 500mA, 8 LED 2W cad
- AI2: converter x max 4 lamps 500mA, 8 LED 2W cad
- AI3: alimentatore IP67 per max 2 lampade 350mA, 4 LED 1W cad
- AI3: converter IP67 x max 2 lamps 350mA, 4 LED 1W cad
- AI4: alimentatore IP67 per max 4 lampade 350mA, 8 LED 1W cad
- AI4: converter IP67 x max 4 lamps 350mA, 8 LED 1W cad
- AI5: alimentatore IP67 a doppia linea per max 12 lampade (6 per linea) 350mA 24LED 1W cad
- AI5: converter IP67 double line x max 12 lamps (6 for line) 350mA, 24 LED 1W cad

GIUNCO

design Albera-Monti 2016



Sottili canne di rame naturale sostengono un diffusore in vetro satinato, che si inseriscono nella vegetazione con discrezione, emanando luce d'atmosfera che evoca piccole lanterne.

Thin natural copper rods support a satin-finished glass diffuser, which fits discreetly into the vegetation, giving off atmospheric light that evokes small lanterns.

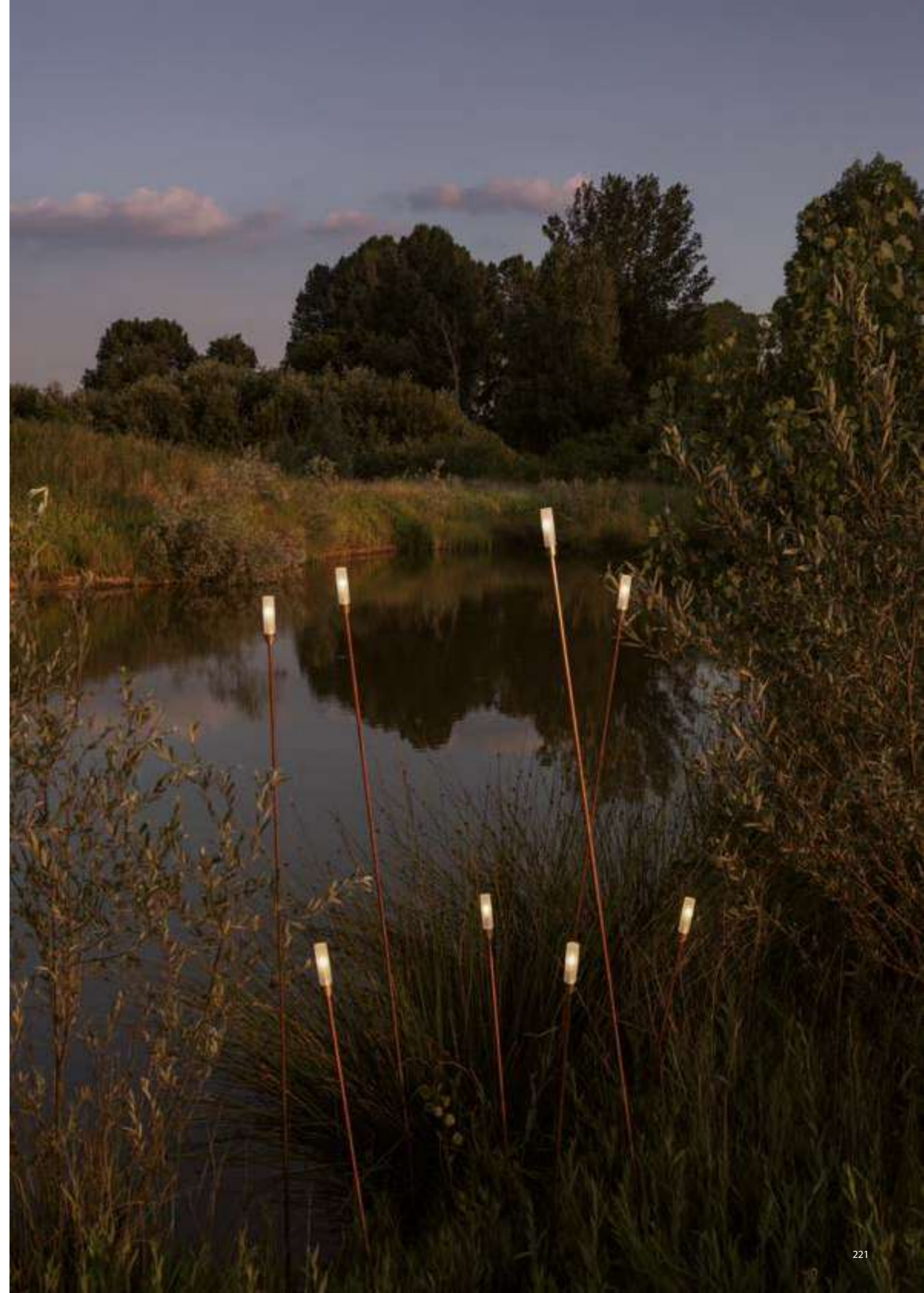



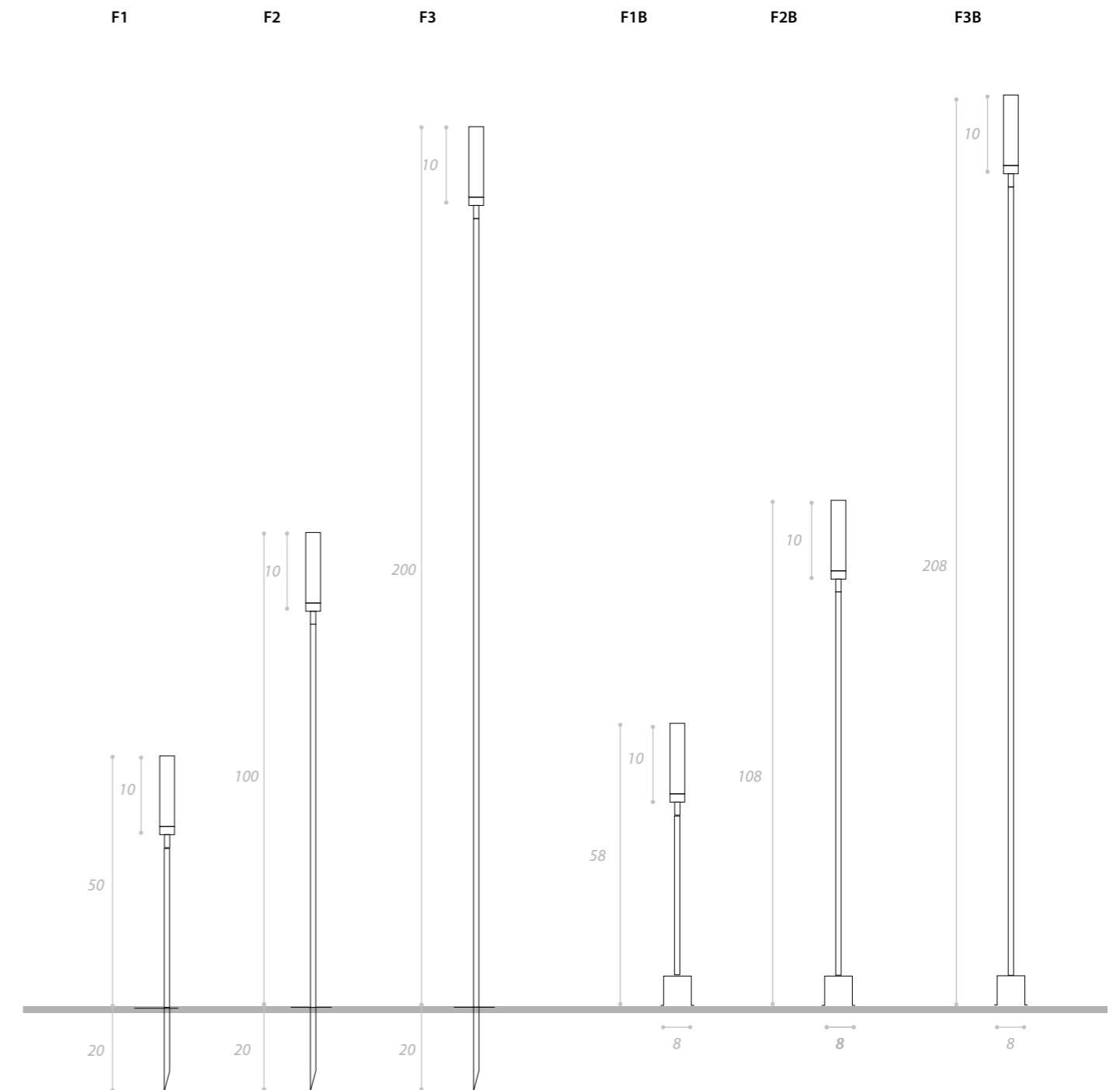

F1
F1B
F2
F2B
F3
F3B

LED G9 110/230V 4W 280lm 3000°k **A+**

MATERIALE: rame- diffusore vetro borosilicato/
 MATERIAL: copper-borosilicate diffusor.

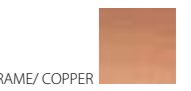

REGOLO

design Gianfranco Marabese 2017



Spot ad alta prestazione, che offre una luce puntuale, mirata. La parte anteriore del piccolo diffusore si sposta come un obiettivo fotografico e modifica il diametro dei coni luminosi, consentendo di incorniciare ed evidenziare dettagli del paesaggio: senza abbagliare, con discrezione.

High performance spotlight, offering a punctual, targeted light. The front of the small diffuser moves like a photographic lens and changes the diameter of the light cones, allowing you to frame and highlight details of the landscape: without dazzling, with discretion.

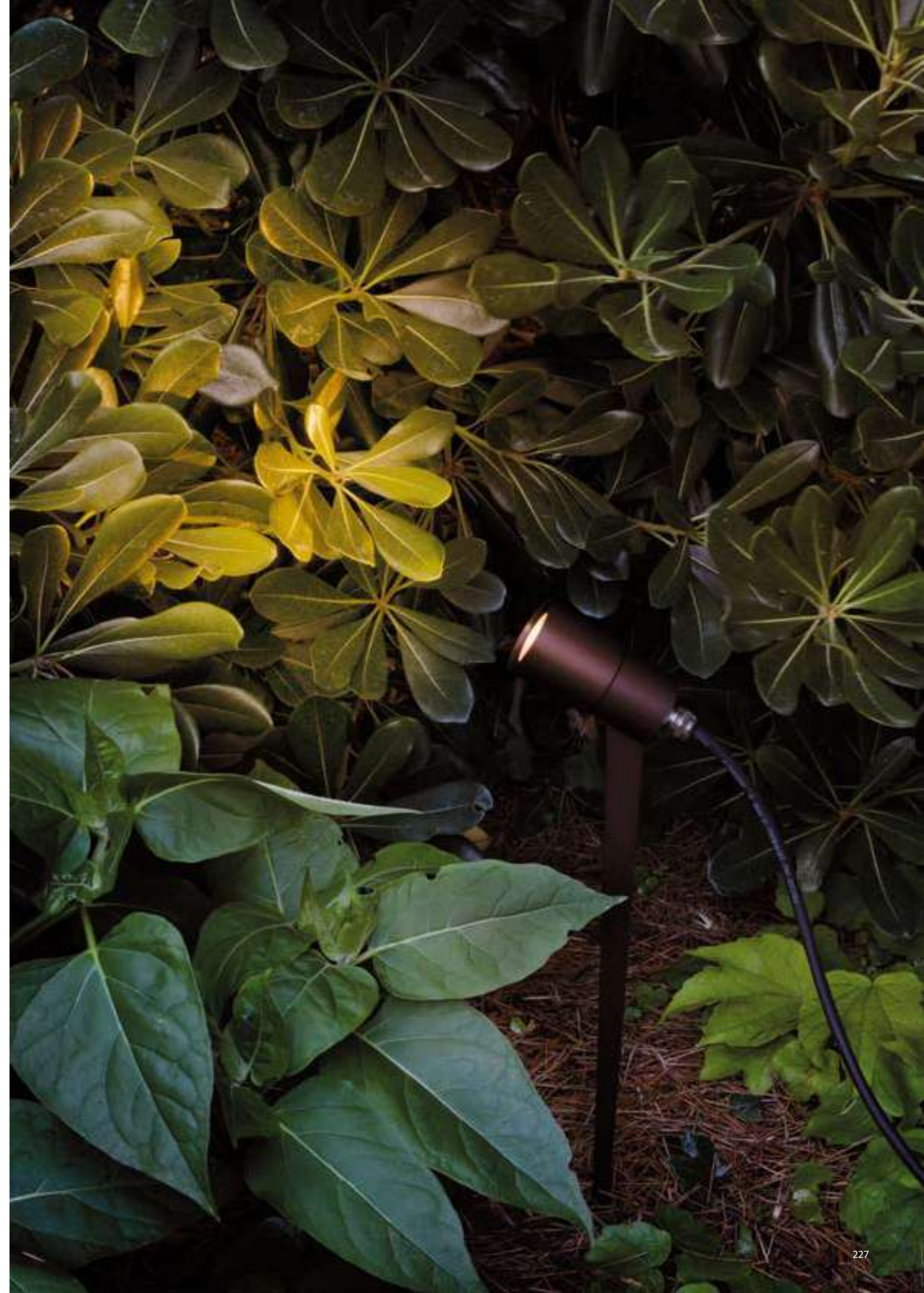

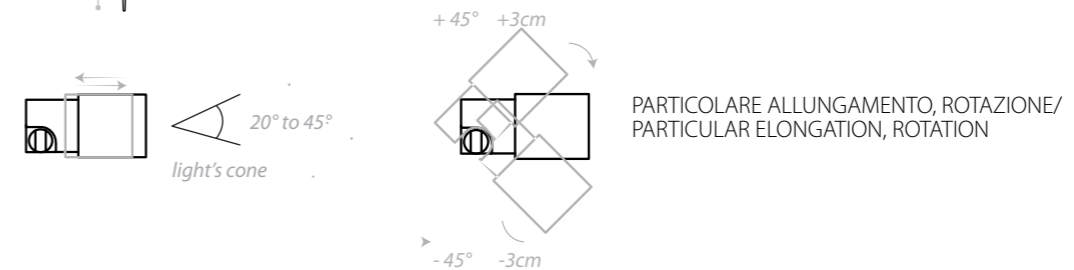
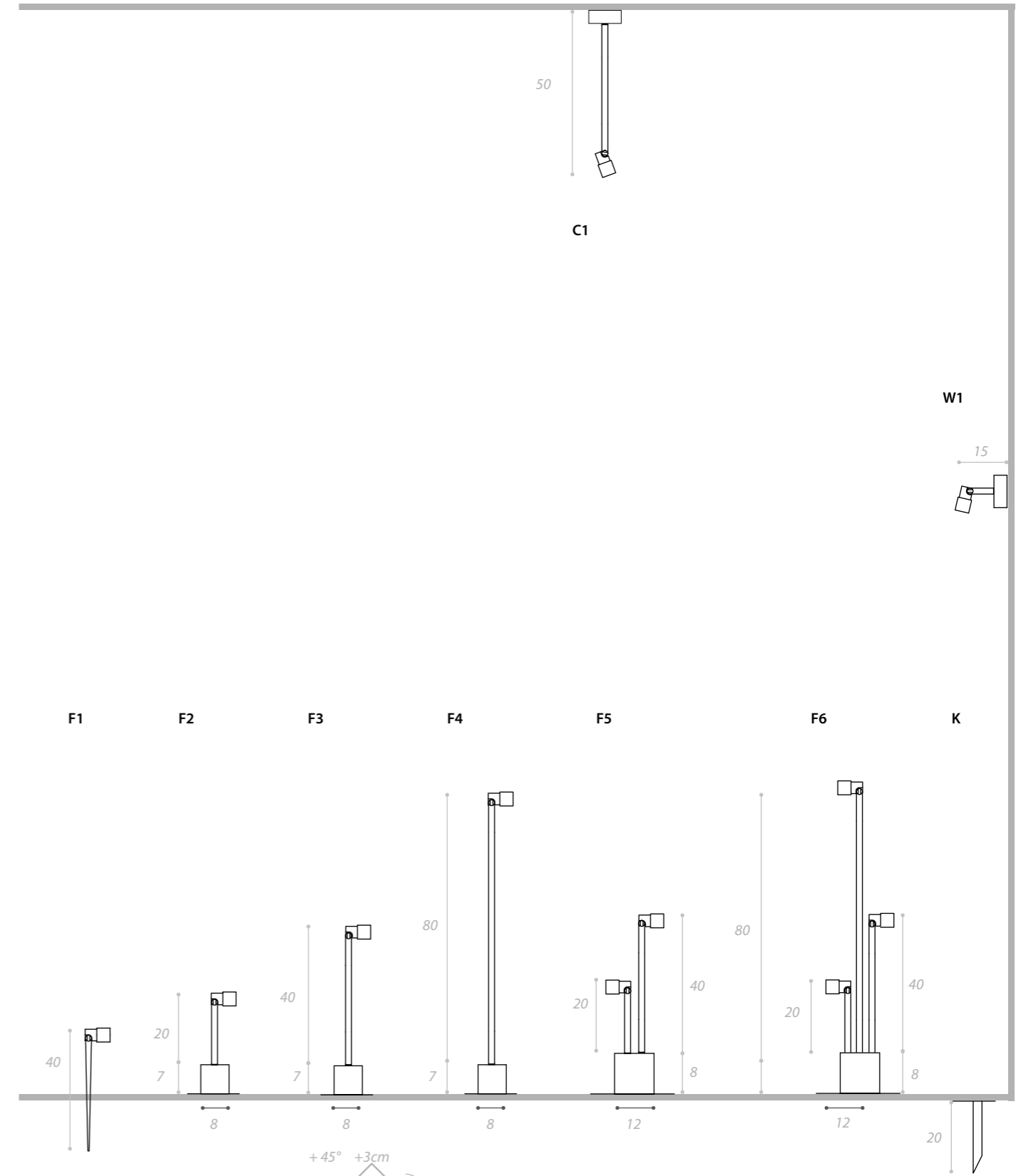

- F1 1x LED 1W 220lm 350mA Driver remoto/ remote driver
- F2/F3/F4/W1/C1 1x LED 1W 220lm 350mA Driver included
- F5 2x LED 1W 220lm 350mA Driver included
- F6 3x LED 1W 220lm 350mA Driver included
- K Picchetto per/Picket for: F2/F3/F4/F5/F6 (optional)

MATERIALE: alluminio/
MATERIAL: aluminium

BRONZO/ BRONZE



LIBERA

design Gianfranco Marabese 2016



Lantern in three dimensions, with light source positioned inside the thin perimeter of metal, which defines its shape and gives a 'floating' effect to the light source.

Lantern in three dimensions, with light source positioned inside the thin perimeter of metal, which defines its shape and gives a "floating" effect to the light source.

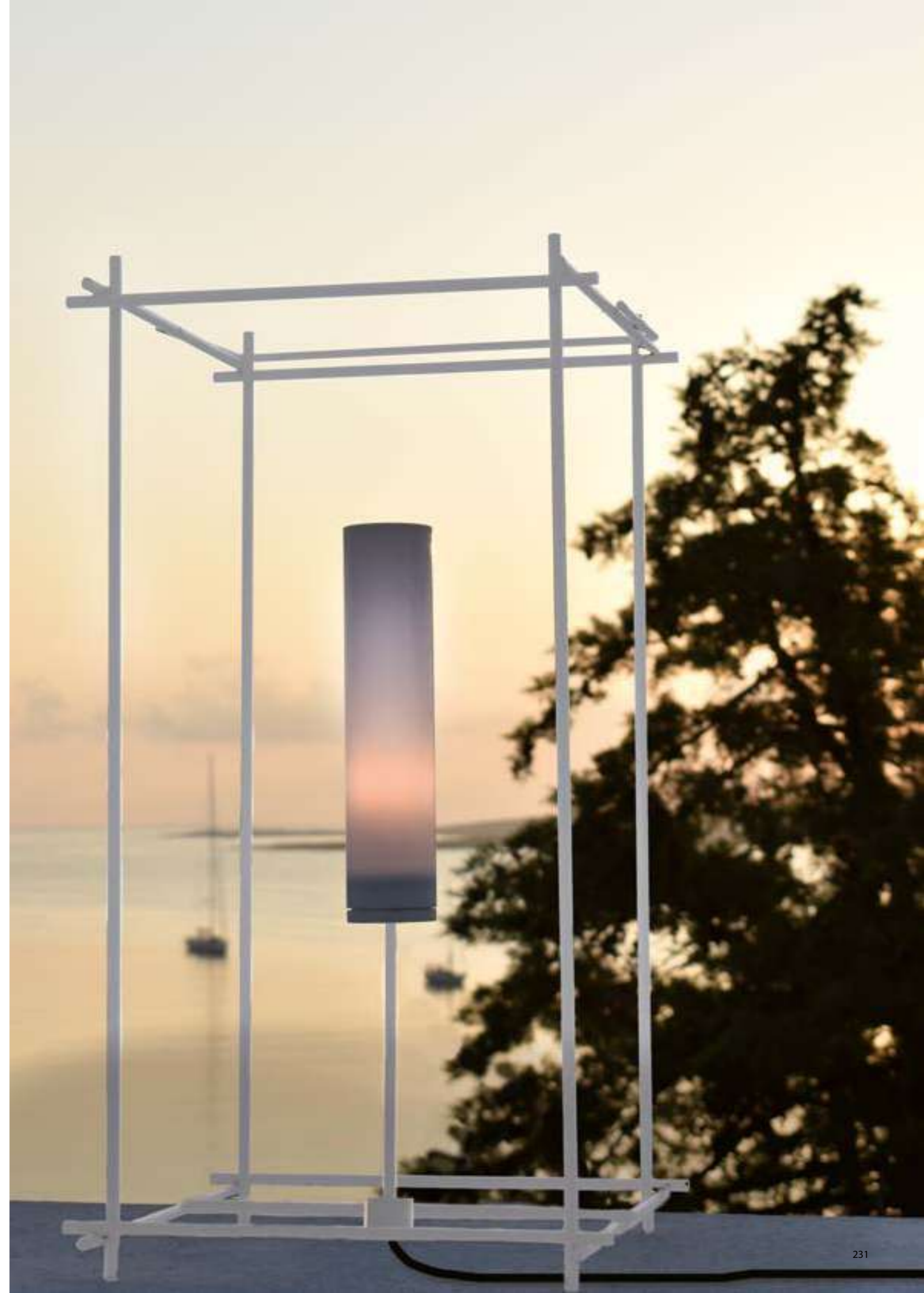



F1

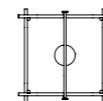

F2

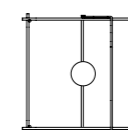

F3

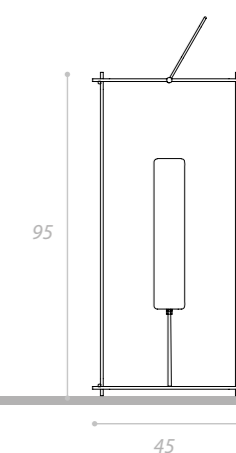
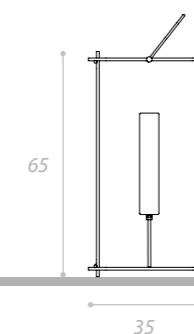
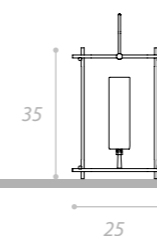
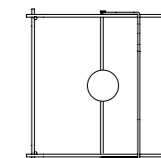

- F1] LED E14 6W 470lm
- F2] LED E14 6W 470lm
- F3] LED E27 20W 2500lm



MATERIALE: metallo/
MATERIAL: metal.



FLAMBEAU

design Giordana Arcesilai 2017



Lampada da appoggio o da sospendere, ricaricabile, per un funzionamento autonomo, senza fili. La raffinata lavorazione in ottone o acciaio, fa filtrare la luce in modo suggestivo, creando effetti luminosi fortemente emozionali.

Standing or hanging lamp, rechargeable, for an autonomous wireless functioning. The refined workmanship in brass or steel, filters the light in a suggestive way, creating highly emotional lighting effects.





RICARICABILE. 12 Ore di luce senza fili
RECHARGEABLE. 12 Hours of light without wires

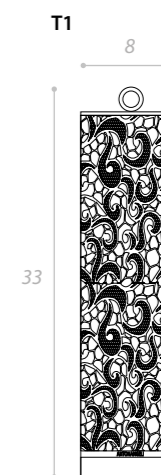

RICARICABILE. 12 Ore di luce senza fili
RECHARGEABLE. 12 Hours of light without wires

MATERIALE: metallo/
MATERIAL: metal

T1 LED 4W 400lm



PULCINELLA

design Giordana Arcesilai 2009



Segna passo da installare a parete, che nella sua morbida forma incorpora la tecnologia LED, completa del suo alimentatore. Pensato per risolvere progetti di luce in cui non è possibile l'incasso (scale, passaggi, camminamenti).

Mark step to be installed on the wall, which incorporates LED technology in its soft form, complete with its power supply. Designed to solve the lighting projects where collection is not possible (stairs, passages, walkways).





W1

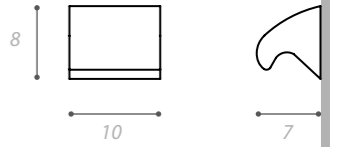

MATERIALE: alluminio/
MATERIAL: aluminium

BIANCO/WHITE

ALLUMINIO/ALUMINIUM

BRONZO/BRONZE



W1 LED 1W 350mA (105lm) driver included **A+**



CU-BOX

design Gianfranco Marabese 2016



Proiettore di luce di dimensioni contenute per illuminare senza abbagliare, nelle diverse tipologie di utilizzo.

Light projector with small dimensions to illuminate without dazzling, in the different types of use.







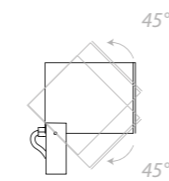
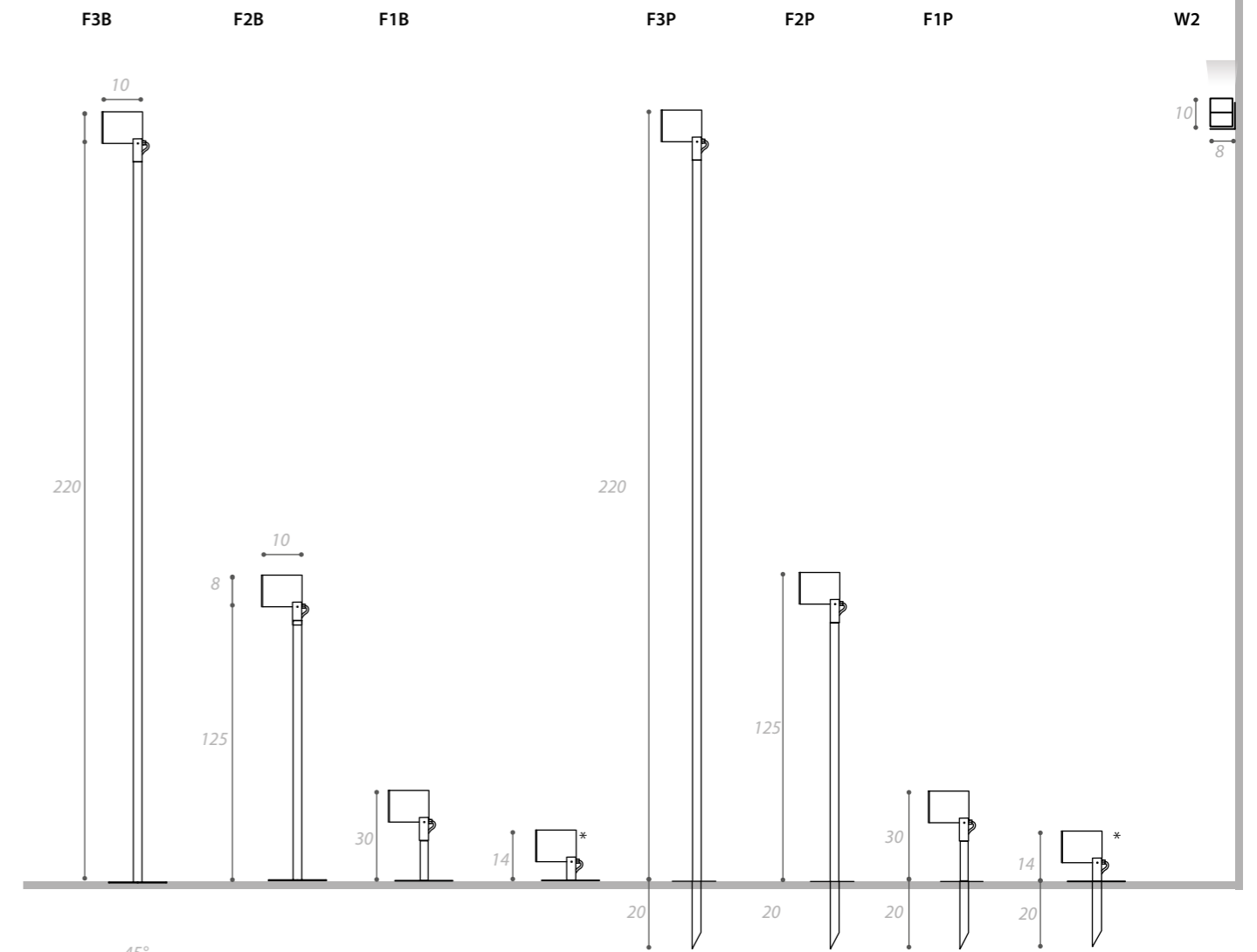

PARTICOLARE ROTAZIONE/
PARTICULAR ROTATION

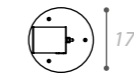

BASE/ BASE

MATERIALE: alluminio/
MATERIAL: aluminium.



F1B/F1P/F2B/F2P/F3B/F3P LED 12W 350mA 3000°k 1500lm **A+** Alimentatore non incluso/Driver non included
W1 LED 12W 350mA 3000°k 1500lm **A+** Alimentatore incluso/Driver included
F1B/F1P * Luce radente asportando il distanziale/Raking light effect removing the spacer



F1B/F1P/F2B/F2P/F3B/F3P a richiesta/on demand

LEGENDA/LEGEND

I Prodotti Antonangeli sono contrassegnati da simboli indicanti conformità a norme di sicurezza internazionale, generali o riferite a particolari condizioni applicative/Antonangeli's products are marked by symbols conforming to International, general safety rules or concerning those particular conditions



Prodotto rispondente alle Direttive Comunitarie Europee/ It certificates the conformity of the product to the European Community provisions



Apparecchio omologato in Classe 1 dotato di messa a terra. In assenza di indicazioni, l'apparecchio è inteso in Classe 1/ Class 1 appliance fitted with basic insulation. Accessible conductors are earthned.



Apparecchio omologato in Classe II, con cablaggio a doppio isolamento/ Class II appliance fitted with double insulation or reinforced insulation



Alimentazione a bassissima tensione di sicurezza. Tensioni superiori a 50V (a 50Hz) escluse. Esclusa messa a terra/ Very low safety supply voltage. Not to be used at over 50V (at 50Hz). Earthing excluded



Apparecchio adatto al montaggio diretto su superfici normalmente infiammabili/ With built-in power packs or transformers ready for mounting on normally flammable surface.



Distanza minima dagli oggetti illuminati/ Minimum distance from illuminated objects



Apparecchio dimmerabile. Dove presente la dicitura "su richiesta", l'apparecchio è acquistabile con sistema dimmer/ Dimmable lamp. Where the words 'on demand' appear, the lamp is affordable with dimming system



Apparecchio presente sia in versione indoor che in versione outdoor/ Device present in both indoor and outdoor version



Apparecchio a prova di dito articolato diametro 12mm/ Apparatus to test of articulate finger diameter 12mm.



Apparecchio a prova di protezione di sonda diametro 2,5mm/ Apparatus to test of probe penetration diameter 2,5mm



Apparecchio a prova di protezione di sonda diametro 1mm/ Apparatus to test of probe penetration diameter 1mm



Protezione contro la polvere/ Protected against dust



protezione contro gocce d'acqua con inclinazione massima di 60°/ protected against water drops with max inclination of 60°





Protezione contro getti d'acqua/ Protected against jets of water



Protezione contro immersione temporanea/ Protected against temporary immersion

ECO-CONTRIBUTO / Normative RAEE DL. 151/2015 H

Vi informiamo che la nostra società ha assolto l'obbligo dello smantellamento delle apparecchiature elettriche ed elettroniche associandosi al consorzio ECOLIGHT/ We inform you that our society has acquitted to the duty of the dismantling of electrical and electronic equipment by joining the consortium ECOLIGHT

Il simbolo  apposto su ogni prodotto ANTONANGELI indica che, per un suo migliore recupero, non deve essere smaltito insieme ad altri rifiuti domestici, ma conferito in idonei centri di smaltimento/ The symbol  on each ANTONANGELI product indicates that, for a better recovery, should not be disposed with other household waste, but given in suitable disposal sites

Antonangeli si riserva la facoltà di modificare, anche senza preavviso, i prodotti o parte degli stessi presenti in questo catalogo. / Antonangeli reserves the right to change the technical specifications of any product illustrated in this catalogue.

Antonangeli produce in Italia nella propria struttura e con il contributo di imprese che nel rispetto dell'ambiente non si avvalgono di manodopera minorile/ Antonangeli produces in Italy by its own structure and with the contribution of enterprises that taking care of environment do not use child labour.

CLASSI ENERGETICHE/ ENERGETIC TABLE

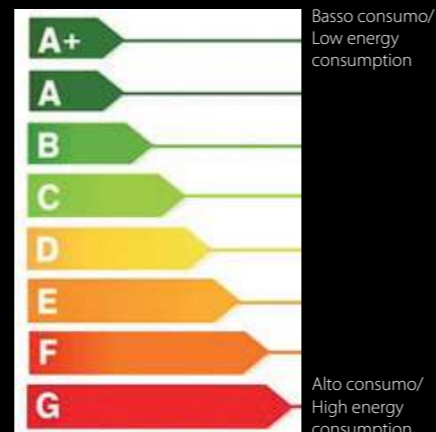

100% MADE IN ITALY

Tutti i prodotti Antonangeli sono realizzati interamente in Italia
All Antonangeli's products are made in Italy

GARANZIA

Questo prodotto realizzato con materiali di qualità, viene garantito da Antonangeli, per due anni, a partire dalla data di acquisto. La garanzia dà diritto alla riparazione o sostituzione gratuita di quelle parti di prodotto sulle quali si riscontrano difetti di fabbricazione, rilevati entro il periodo coperto dalla stessa. Esulano dalla garanzia danni causati da trasporto, derivanti da manomissioni o da manutenzioni improprie. In caso di difetto, il prodotto va riconsegnato, se possibile con imballo originale al rivenditore presso cui è stato acquistato, insieme al certificato di garanzia. Ogni prodotto Antonangeli è coperto da polizza assicurativa per la responsabilità civile prodotti. Per qualsiasi controversia sarà competente, in via esclusiva, il foro di Milano, Italia.

WARRANTY

This product is manufactured using high quality materials, and Antonangeli guarantees it for two years from date of purchase. The certificate warrants that those part of the product defective by improper workman ship will be replaced or repaired free of charge during all the period of guarantee's validity. This guarantee does not apply to shipping damage, misuse or improper maintenance. In case of defective parts the product must be handed, along with the guarantee certificate and if possibile in its original package to the dealer who sold it. All Antonangeli products are covered by an insurance police. Court of law competent to consider claims concerning this product is that of Milan, Italy.

Copyright Antonangeli 2019

E' vietata la riproduzione e l'utilizzo delle immagini di questo catalogo senza autorizzazione da parte di CHORE S.R.L.
It is forbidden the use and the reproduction of the pictures present in thi catalogue without the permission of CHORE S.R.L.
Photo: Lorenzo Ceretta/ Michele Poli Mascheroni/Leonardo Pelucchi/Andrea Pitari/Marco Pratali/Marco Varoli/Max Zambelli
Graphic Design: Antonio Dibiasi.



Chore s.r.l. Via Como 74 20030 Paderno Dugnano (MI) Italy
antonangeli.it info@antonangeli.it Ph.one: +39 02 91082795